



PRELIMINARY REPORT – BLACK SYSTEM EVENT IN SOUTH AUSTRALIA ON 28 SEPTEMBER 2016

A PRELIMINARY OPERATING INCIDENT REPORT FOR THE
NATIONAL ELECTRICITY MARKET – INFORMATION AS AT
9.00 AM, MONDAY 3 OCTOBER 2016

Published: 5 October 2016





IMPORTANT NOTICE

Purpose

AEMO has prepared this preliminary report as part of its review of the Black System event in South Australia on Wednesday 28 September 2016, under clauses 3.14 and 4.8.15 of the National Electricity Rules (Rules), and as a first step in reporting under those provisions of the Rules.

The observations in this report will be updated as new information becomes available.

Information in this update is current as at 9.00 am on Monday 3 October 2016.

Disclaimer

AEMO has been provided with preliminary data by Registered Participants as to the performance of some equipment leading up to, during, and after the Black System event in accordance with clauses 3.14 and 4.8.15 of the Rules. In addition, AEMO has collated information from its own systems. The information provided by Registered Participants and collated from AEMO's own systems is preliminary information only. Any analysis and conclusions in these findings are also preliminary in nature.

While AEMO has made every effort to ensure the quality of the information in this report, its investigations are incomplete and the findings expressed in it may change as further information becomes available and further analysis is conducted. AEMO will publish its final operating incident report as required by clause 4.8.15 and its report into the suspension of the spot market under clause 3.14 of the Rules. Any views expressed in this report are those of AEMO unless otherwise stated, and may be based on information given to AEMO by other persons.

Accordingly, to the maximum extent permitted by law, AEMO and its officers, employees and consultants involved in the preparation of this report:

- make no representation or warranty, express or implied, as to the currency, accuracy, reliability or completeness of the information in this report; and,
- are not liable (whether by reason of negligence or otherwise) for any statements or representations in this report, or any omissions from it, or for any use or reliance on the information in it.

Copyright

© 2016. Australian Energy Market Operator Limited.



ABBREVIATIONS

Abbreviation	Term
AEMO	Australian Energy Market Operator
CB	Circuit Breaker
AEST	Australian Eastern Standard Time
FCAS	Frequency Ancillary Control Services
Hz	Hertz
kV	Kilovolt
MW	Megawatt
NEM	National Electricity Market
NER	National Electricity Rules
NSP	Network Service Provider
SA	South Australia
SRAS	System Restart Ancillary Service



TERMINOLOGY

The references to times included in this report are based on market time, being AEST, not local time in South Australia. (Note that Appendix B, Weatherzone’s weather event report, uses CST).

This report has been prepared on the basis of information available and modelling conducted as of 9:00, Monday 3 October 2016.

This report is divided into the following sections:

Pre-event – the status of the power system in SA prior to the first observed fault that lead to the Black System (before 16:16:46).

The event – the sequence of events on the power system that occurred in the South Australian (SA) region of the National Electricity Market (NEM) between the first observed fault and system shutdown (16:16:46 to 16:18:16).

SA region Black System – is the point at which the system shut down in SA which occurred at 16:18:16 Wednesday, 28 September 2016.

Post event – the sequence of steps taken to restore the SA power system after the system shutdown (from 28 September 2016 at 16:18:16 to 29 September 2016 at 18:25).

Next Steps – the proposed next steps to further investigate the Black System event



EXECUTIVE SUMMARY

Event summary

The purpose of this report is to provide the Australian Energy Market Operator's (AEMO) preliminary information regarding the 'Black System' event in South Australia (SA) which occurred at 16:18 on Wednesday 28 September 2016.

This preliminary report reflects initial observations based on data provided to date. Information and observations may change or be refined as new data becomes available, and AEMO intends to update this report regularly. More thorough observations and investigations will be reported at a later date.

This preliminary report will look at initial observations about the pre-event situation, the event, and restoration, and will outline next steps.

Pre-event

As per standard operating arrangements, AEMO, on 27 September 2016, received advice regarding the potential for a severe weather front to move across SA on 28 September 2016.

The electricity system in SA was stable and there was no unusual activity on the system.

Immediately before the event, approximately 880 MW of SA wind generation, 330 MW of SA gas generation, and 610 MW of electricity imports via two interconnections with Victoria were collectively supplying 1,895 MW of electricity demand¹ to SA's 850,000 customer connections.

Event

The predicted weather front moved through SA on the afternoon of Wednesday 28 September 2016, including high winds, thunderstorms, lightning strikes, hail, and heavy rainfall.

The weather resulted in multiple transmission system faults. In the short time between 16:16 and 16:18, system faults included the loss of three major 275 kV transmission lines north of Adelaide.

Generation initially rode through the faults, but at 16:18, following an extensive number of faults in a short period, 315 MW of wind generation disconnected (one group at 16:18:09, a second group at 16:18:15), also affecting the region north of Adelaide.

The uncontrolled reduction in generation resulted in increased flow on the main Victorian interconnector (Heywood) to make up the deficit.

This resulted in the Heywood Interconnector overloading. To avoid damage to the interconnector, the automatic-protection mechanism activated, tripping the interconnector. In this event, this resulted in the remaining customer load and electricity generation in SA being lost (referred to as a Black System).

This automatic-protection operated in less than half a second at 16:18.

The event resulted in the SA regional electricity market being suspended.

Restoration

A 'Black System' start is a pre-defined and practised plan which was activated following assessment of the electricity system and public and employee safety.

At 17:23, AEMO directed the SA transmission network owner ElectraNet to progressively energise the main Victorian interconnector through to Adelaide to start Torrens Island Power Station and provide a basis to allow customer supply to be restored.

¹ Other generation sources distributed within the generation network also contributed to meeting demand at this time, but detailed data is not available at this time.

Restoration of electricity supply started in Adelaide at 19:00. By midnight on Wednesday 28 September 2016, 80–90% of electricity (that could be restored) was restored.

The remaining electricity load could not be restored, as the loss of three of the four 275 kV transmission lines north of Adelaide, together with the unknown status of the fourth line (which required physical inspection), effectively cut the SA transmission grid in two, isolating the north of the state.

In accordance with standard industry practices to protect public safety and the safety of ElectraNet's field crews, the transmission lines north of the Adelaide metropolitan area could not be re-energised before visual inspection on the morning of Thursday 29 September 2016. Continued poor weather conditions and high winds kept helicopters grounded, making slower ground patrols of the transmission network necessary.

The northern line confirmed intact was re-energised at 12:15 on Thursday 29 September 2016, allowing some electricity to be restored in the northern region.

Supply to the three large industrial sites in the north of the state remains constrained due to the limitations which remain in the northern region.

At 21:00 on Friday 30 September 2016, the last remaining segment of transmission supply, the southern Eyre Peninsula, was restored.

Temporary transmission tower structures owned by ElectraNet have been deployed, and also contributed by network owners in other states to assist in the restoration. Access continues to be hindered by poor weather conditions and flooding. Consequently, the restoration of the second and third lines is expected to take 7–10 days.

On Thursday 29 September 2016, pursuant to clause 3.14.3 (2) of the National Electricity Rules (Rules), AEMO was directed to suspend the market in the SA National Electricity Market region by Ministerial direction by the South Australian Government under the Essential Service Act 1981.

The SA wholesale electricity market remains suspended and prices continue to be determined in accordance with schedules and processes defined in the Rules.

Next steps

While the event was triggered by extreme weather, AEMO will conduct a thorough investigation into how each component of the electricity system responded under these circumstances. A table of those investigations and activities is included in this report.



CONTENTS

TERMINOLOGY	3
EXECUTIVE SUMMARY	2
1. REPORT OBJECTIVE	6
1.1 Roles and responsibilities	6
2. PRE-EVENT	7
2.1 Weather details	7
2.2 Pre-event system configuration	7
3. EVENTS RESULTING IN BLACK SYSTEM	10
3.1 Line trips	13
3.2 Network damage resulting from the storm	13
3.3 Generation response	14
3.4 Heywood interconnector	14
3.5 SA region Black System	14
4. RESTORATION	16
4.1 Roles and responsibilities	16
4.2 Restoration plan	17
4.3 Restoration sequence of events	17
4.4 Load restoration	19
4.5 Use of SRAS	19
4.6 Interconnection to Victoria	19
4.7 Conclusion of Black System event	20
5. NEXT STEPS	21
APPENDIX A. POWER SYSTEM DIAGRAM	22
APPENDIX B. WEATHER EVENT REPORT	23
APPENDIX C. WEATHER EVENT REPORT	27
APPENDIX D. SA REGION TRANSMISSION SYSTEM	28

TABLES

Table 1	Generators online	8
Table 2	SA constraints invoked pre-event	9
Table 3	Events resulting in Black System	10
Table 4	Reduction in generation during the event	14
Table 5	Load restoration sequence of events	17
Table 6	Summary of activities	21



FIGURES

Figure 1	SA generation mix pre-event	8
Figure 2	Heywood separation pre-event and event	11
Figure 3	Flow on Heywood – South East interconnector during the event	12
Figure 4	SA frequency during the event	12
Figure 5	Frequency response and RoCoF during pre-event and event	15
Figure 6	Comparison of forecast and actual load	16



1. REPORT OBJECTIVE

On Wednesday 28 September 2016, at 16:18, electricity supply in South Australia (SA) was lost with a Black System occurring across the state.

The objective of this report is to provide a preliminary overview of the sequence of events that resulted in the SA region Black System and the steps taken to restore power to the power system.

The root cause is subject to further analysis being conducted and additional information that may be provided. The magnitude of transmission faults due to weather in a short period of time, resulting in significant voltage dips and loss of load, resulted in system instability. This caused some generators to reduce output, increasing flow on remaining power system equipment, causing power system protection to operate to remove risk of damage. Insufficient analysis has presently been undertaken to determine if everything operated as designed during the event.

1.1 Roles and responsibilities

The interconnected power system in eastern Australia is an aggregation of plant and systems that are owned and operated by many disparate entities. For the purposes of this event there are two entities – AEMO and ElectraNet – which collectively operate the SA power system with the following roles:

- AEMO: power system and market operator – dispatches generation, determines prices and directs network operation.
- ElectraNet: transmission network operator – owns, controls and operates the transmission system.

Generating plant in SA is of various technologies and size. Generators mainly operate by following dispatch instructions² issued by AEMO. Electricity is typically transported from generators over the transmission network to distribution networks³ which then deliver electricity to end users.

This event mainly involves the ElectraNet transmission system, various generators, and AEMO's operation of the power system.

² Based on prices submitted by generators.

³ SA Power Networks in SA.



2. PRE-EVENT

This section outlines the state of the power system in the period directly prior to the events resulting in a Black System on Wednesday 28 September 2016, at 16:18. This resulted in the loss of supply to all customers in SA (approximately 1,895 MW of demand).

Appendix A contains a diagram illustrating the SA 275 kV transmission network before the event.

2.1 Weather details

At the time of the SA Black System, there were severe weather conditions in SA. A report from Weatherzone (see Appendix B) has confirmed that:

- There was an “intense low pressure system” that “brought severe weather to SA” from Wednesday 28 September 2016 until early Friday 30 September 2016.
- The low pressure system and associated pre-frontal trough and cold front “triggered especially severe thunderstorms (including tornadoes)” as it crossed SA on 28 September 2016.
- The “complex weather system affected large parts of southern and south-eastern Australia, with damaging to destructive winds, widespread thunderstorms, cloud to ground lightning strikes, damaging hail, and heavy rainfall (leading to flooding) over SA in particular”.

Appendix C has reports from the Bureau of Meteorology.

2.2 Pre-event system configuration

Pre-event operational demand⁴ in the SA region was being supplied by a combination of thermal (synchronous) generation, wind generation, and imports from Victoria across both the Heywood Interconnector and Murraylink DC cable.

A summary of the generation mix prior to the event is outlined below.

⁴ Operational demand refers to the electricity used by residential, commercial, and large industrial consumers, as supplied by scheduled, semi-scheduled, and significant non-scheduled generating units.

Figure 1 SA generation mix pre-event

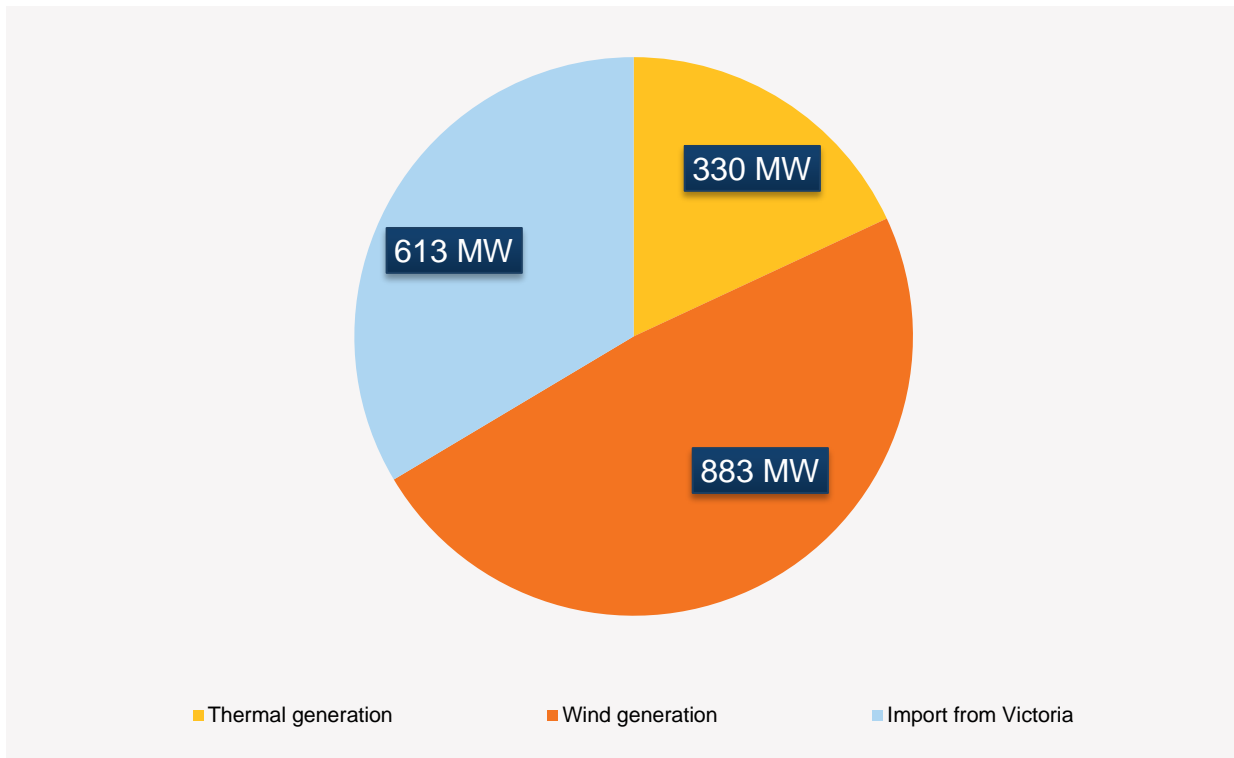

The table below sets out the output of the generators on line at the time of the SA Black System, including the substation and lines they connect to.

Table 1 Generators online

Generator	Type	Output (MW)	Substation	Lines connected
The Bluff WF	Wind	43	Belalie	Davenport-Belalie Belalie-Mokota
Clements Gap WF	Wind	14	Redhill	Redhill-Bungama Redhill-Brinkworth
Canunda WF	Wind	43	Snuggery	Snuggery-Mayurra-South East Snuggery-Blanch
Hallett WF	Wind	38	Canowie	Canowie-Mt Lock Canowie-Robertstown
Hallett Hill WF	Wind	42		
Hornsedale WF	Wind	86	Mt Lock	Mt Lock-Davenport Mt Lock-Canowie
Ladbroke Grove Unit 1	Thermal	42	Ladbroke Grove	Ladbroke Grove-Penola West
Ladbroke Grove Unit 2	Thermal	40		
Lake Bonney 1 WF	Wind	77	Mayurra	Mayurra-Snuggery-South East
Lake Bonney 2 WF	Wind	149		
Lake Bonney 3 WF	Wind	35		
Mt Millar WF	Wind	66	Yadnarie	Yadnarie-Middleback Yadnarie-Port Lincoln
North Brown Hill WF	Wind	85	Belalie	Davenport-Belalie Belalie-Mokota
Snowtown North WF	Wind	44	Snowtown	Snowtown-Blyth West
Snowtown South WF	Wind	65		
Torrens Island B PS Unit 1	Thermal	82	Torrens Island	Torrens Island-Para Torrens Island-LeFevre
Torrens Island B PS Unit 3	Thermal	84		

Generator	Type	Output (MW)	Substation	Lines connected
Torrens Island B PS Unit 4	Thermal	82		Torrens Island-Magill Torrens Island-City West Torrens Island-Cherry Gardens Torrens Island-North Field Torrens Island-Kilburn
Waterloo WF	Wind	95	Waterloo East	Waterloo East-Waterloo Waterloo East-Robertstown

Note: Snowtown 2 is comprised of Snowtown North and Snowtown South wind farms.

The following transmission lines were out of service pre-event:

- Pimba – Olympic Dam 132 kV line. Note this line is normally out of service.
- Torrens Island PS – City West 275 kV line. This line was out due to a planned outage.

The constraints in the following table were invoked pre-event.

Table 2 SA constraints invoked pre-event

Constraint Set	Time Invoked	Time Revoked	Description
S-NIL	12/10/2001 09:05	31/12/9999 00:00	Out = Nil, SA System Normal
F-MAIN_RREG_0300	28/09/2016 15:55	28/09/2016 16:50	Mainland Raise Regulation Requirement greater than 300 MW

There was no local SA Regulation FCAS requirement pre-event, as there was no credible risk of separation of SA from the National Electricity Market (NEM).

3. EVENTS RESULTING IN BLACK SYSTEM

The table below sets out the sequence and timing of the event.

Table 3 Events resulting in Black System

Time	Event
16:16:46 (T-90s)	Fault on Northfield–Harrow 66 kV feeder in Adelaide metropolitan area network. <ul style="list-style-type: none"> • Trip and successful reclose. No impact on main transmission system. • No significant change in generation or load observed.
16:17:33 (T-43s)	Two-phase-to-ground fault on Brinkworth – Templers West 275 kV line. <ul style="list-style-type: none"> • Line remains open, and requires physical patrol before re-energisation is attempted. • Line remains out of service as at 30/9/16 12:00. • No significant change in generation or load observed. Total – One 275 kV transmission line out of service.
16:17:59 (T-17s)	Single-phase-to-ground fault on Davenport – Belalie 275 kV line. <ul style="list-style-type: none"> • Fault location is estimated to have occurred on structure 93 (42 km from Davenport). • Line is successfully reclosed, after delay of 1 seconds. • No significant change in generation or load observed.
16:18:08 (T-8s)	Single-phase-to-ground fault on Davenport – Belalie 275 kV line. <ul style="list-style-type: none"> • As fault is within 30 seconds of previous fault (reclaim time window), no reclose attempted. • Line is opened on all 3 phases, and locked out. • Physical patrol of line required before re-energisation is attempted. Total – Two 275 kV transmission lines out of service.
16:18:09 (T-7s)	123 MW reduction in output from North Brown Hill Wind Farm, Bluff Wind Farm, Hallett Wind Farm, and Hallett Hill Wind Farm.
16:18:13 (T-3s)	Single-phase-to-ground fault on Davenport – Mt Lock 275 kV line. <ul style="list-style-type: none"> • Note: Davenport – Mt Lock 275 kV line is on other side of the same double circuit tower as the Davenport – Belalie 275 kV line. • Reclose attempted after approx. 1 second – 16:18:14. • Reclose unsuccessful, fault is still present, line opens on all 3 phases and is locked out. • Physical patrol of line required before re-energisation is attempted. • Fault location is recorded as structure 97 (43.5km from Davenport). Total – Three 275 kV transmission lines out of service.
16:18:15.1 (T-0.9s)	<ul style="list-style-type: none"> • 86 MW reduction in output from Hornsdale wind farm. • 106 MW reduction in output from Snowtown 2 wind farm.
16:18:15.5 (T-0.5s)	Flow across Heywood Interconnector increased to over 850 MW.
16:18:15.8 (T-0.2s)	South East – Heywood No.1 275 kV line opens at South East. South East – Heywood No.2 275 kV line opens at South East. Synchronous Separation between South Australia and Victoria.
16:18:16 (T=0)	Supply lost to all South Australia region of the NEM. <ul style="list-style-type: none"> • Torrens Island power station trip. • Ladbroke Grove power station trip. • All remaining wind farms trip. • Murraylink interconnector trip.

Note: Events are listed based on data known at this time. Additional information is expected to become available and will be reported.

Figures 1 and 2 below show the flow on the lines Heywood – South East 275 kV transmission lines during the event. These transmission lines form part of the electrical interconnection between SA and Victoria. Figure 3 sets out the system frequency during this period.

Figure 2 Heywood separation pre-event and event

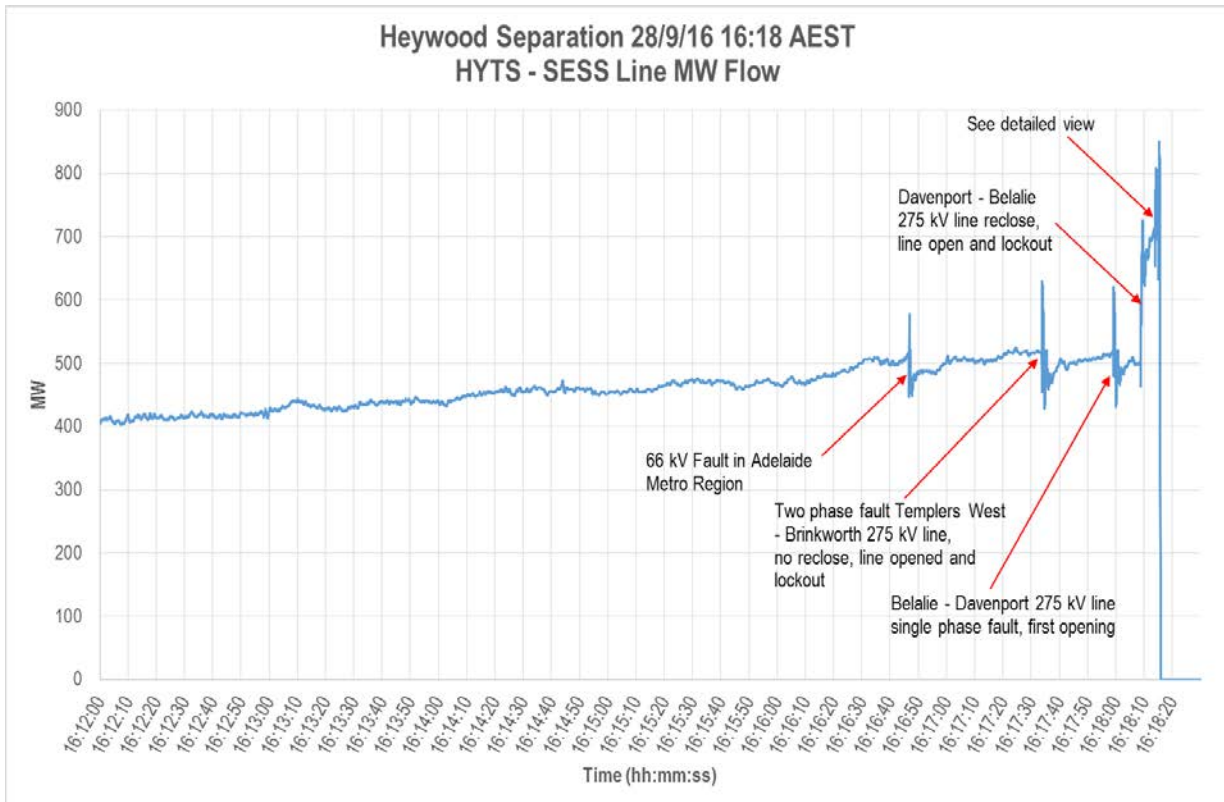

Note: Lockout is where the protection system prevents the circuit from being automatically reconnected, operator intervention is required.

Figure 3 Flow on Heywood – South East interconnector during the event

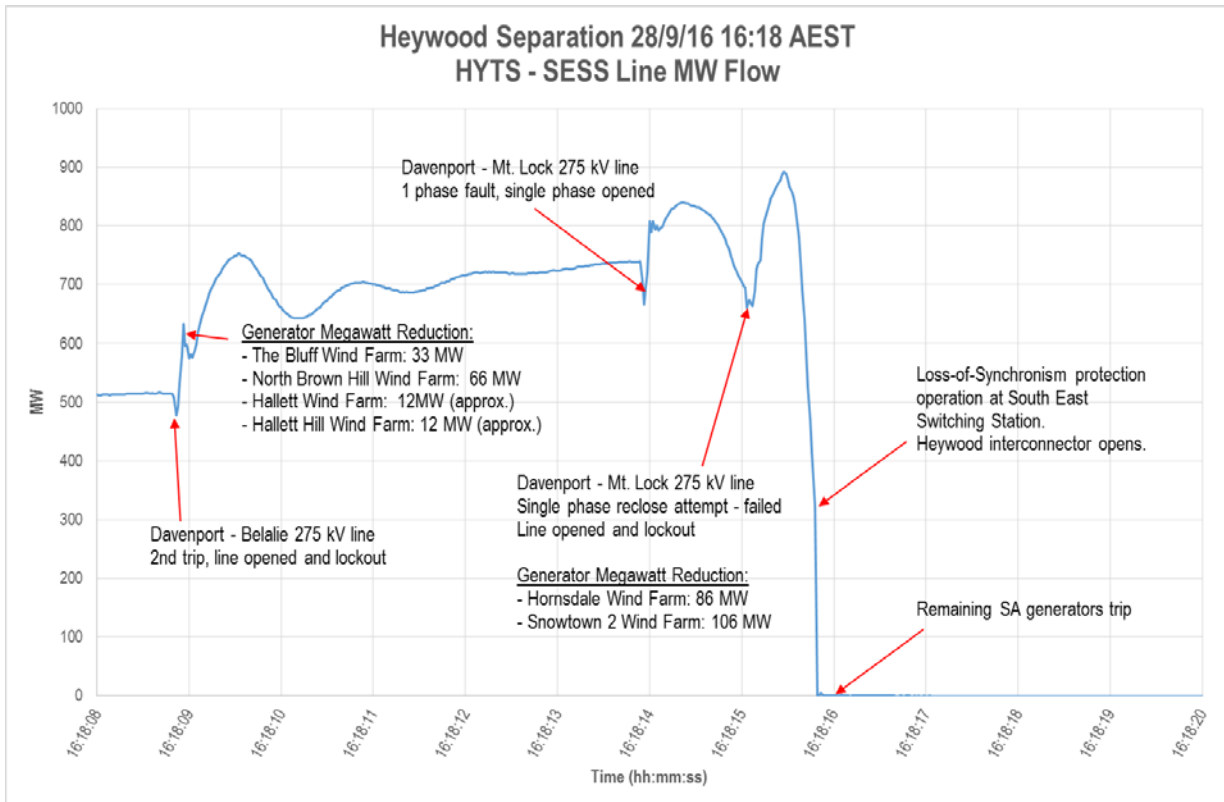
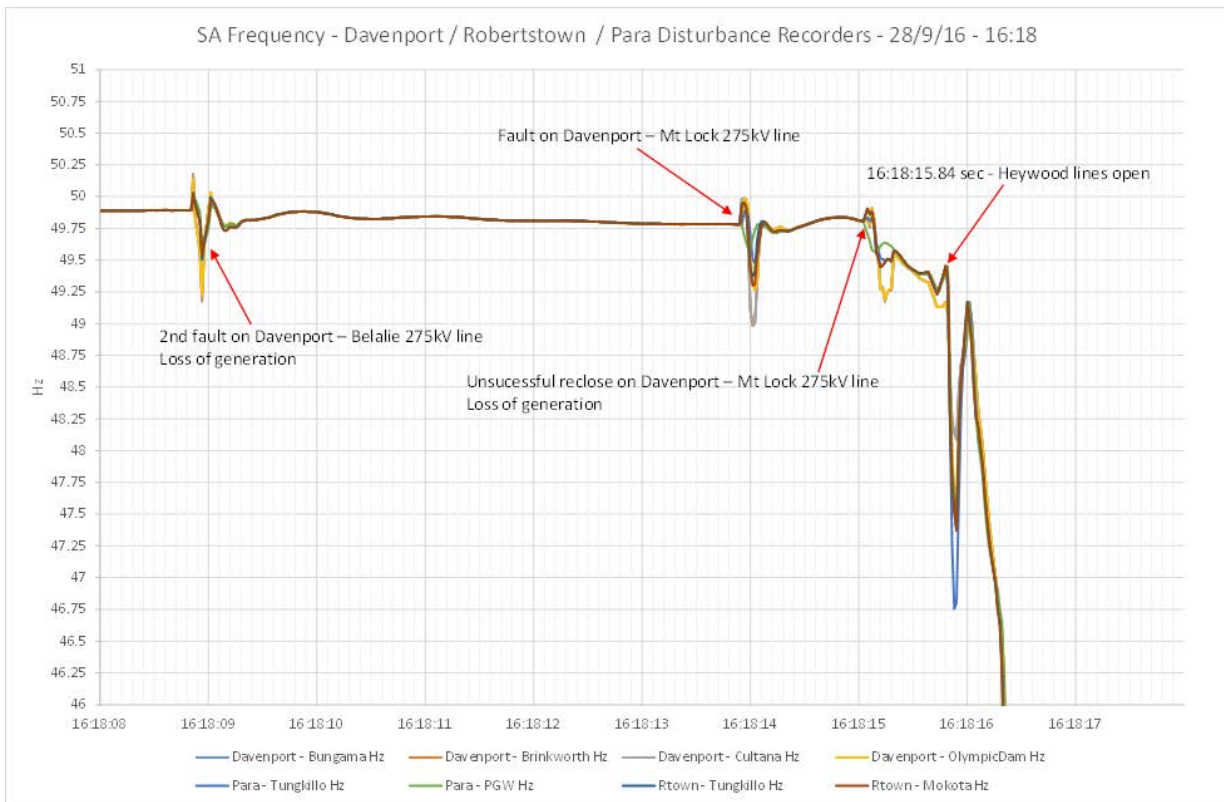

Figure 4 SA frequency during the event



Further to the table and charts above, the observations in the following sections are made.

3.1 Line trips

A number of transmission line faults occurred before separation. These included those outlined below.

3.1.1 Brinkworth – Templers West 275 kV transmission line

At 16:17:33, Brinkworth – Templers West 275 kV line tripped due to a two phase to ground fault. No automatic reclose was attempted on this line. AEMO has been advised that it is ElectraNet operating procedure to conduct a patrol before reclosing line when such a fault occurs. No reduction in generation was identified in response to this fault.

3.1.2 Davenport – Belalie 275 kV transmission line

The faults on the Davenport – Belalie line were estimated to be 42 km from Davenport.

At 16:17:59, there was a single phase to ground fault on the Davenport – Belalie 275 kV line. The faulted phase tripped out of service. The other two phases remained in service. At 16:18:00, one second after the initial fault the faulted phase was automatically reclosed to return the line to normal operation. No reduction in generation was identified in response to this fault.

At 16:18:08, there was a second single phase to ground fault on this line. As this fault occurred within 30 seconds of the previous fault, all three phases of the line are tripped and no automatic reclose is attempted. The line remained out of service.

3.1.3 Davenport – Mt Lock 275 kV transmission line

The faults on the Davenport – Mt Lock line were estimated to be 43.5 km from Davenport.

At 16:18:13, there was a single phase to ground fault on the Davenport – Mt Lock 275 kV line. The faulted phase tripped out of service. The other two phases remained in service. At 16:18:14, one second after the initial fault the faulted phase was automatically reclosed. As the fault was still on the line the reclose attempt failed and all three phases of the line were tripped. No further automatic reclose attempt was made and the line remained out of service.

3.2 Network damage resulting from the storm

Following the SA Black System, ElectraNet advised AEMO of network damage resulting from the storm. This included:

- Davenport to Mt Lock and Davenport to Belalie 275 kV line – 5 double circuit towers damaged.
- Brinkworth to Templers West 275 kV line (East circuit) – 2 towers damaged.
- Davenport to Brinkworth 275 kV line (East circuit) – 14 towers damaged.
- Port Lincoln to Yadnarie 132kV line – 1 tower damaged.

Data currently available to AEMO indicates that the damage to the Davenport – Brinkworth 275 kV or the Port Lincoln – Yadnarie 132 kV lines occurred following the SA Black System.

3.3 Generation response

In the events leading up to SA region Black System, generation reduction occurred at six wind farms. There was no reduction in thermal generation. Each reduction coincided with a drop in voltage observed at the wind farms' connection points. Details of the generation reduction and the observed voltage levels are shown in the following table:

Table 4 Reduction in generation during the event

Time	Generating systems that exhibited an active power reduction	Generation prior to the event (MW)	Generation at the end of the event (MW)
16:18:09.2	Bluff WF	42	9
16:18:09.2	North Brown Hill WF	87	21
16:18:09.2	Hallett WF	36	24 (approximate)
16:18:09.2	Hallett Hill WF	34	22 (approximate)
16:18:15.1	Hornsedale WF	84	-2
16:18:15.2	Snowtown II WF	104	-2

Note: Events are listed based on data known at this time. Additional information is expected to become available and will be reported.

Note that the values set out in section 2.2 were recorded pre-event using AEMO data systems. The values in the table above are from high speed data recordings provided to AEMO from participants and ElectraNet. As such there is a small discrepancy in the generation values.

Additional analysis is required to determine the reasons for the reduction in generation and observed voltage levels before any conclusions can be drawn.

3.4 Heywood interconnector

At 16:18:00, just prior to the trip of the Davenport – Belalie and Davenport – Mt Lock transmission lines, the flow on the Heywood interconnector was approximately 525 MW. Note that this is within normal operating limits of up to 600 MW transfer from Victoria to South Australia.

The reduction in generation during the event, combined with oscillations caused by faults on the transmission network, caused the flow on the Heywood interconnector⁵ to increase to approximately 850 – 900 MW by 16:18:15. Flows between 850 – 900 MW are in excess of the design limits of the interconnector.

Protection settings are in place to avoid damage to network and generation infrastructure in the event of system faults. These settings mean that equipment will open automatically to avoid system damage. At 16:18:15.8, in response to the high power flows on the Heywood interconnector, the protection at South East substation operated to open the Heywood interconnector.

3.5 SA region Black System

Generator performance standards after 2007 require generating units to remain on line for a Rate of Change of Frequency (RoCoF) of 1 Hz/second for 1 second as a minimum, and up to 4 Hz/second for 0.25 seconds. RoCoF must be maintained within this limit to prevent damage to generating units and effective operation of protection relays and emergency control schemes such as the automatic Under Frequency Load Shedding (UFLS) scheme.

The UFLS scheme in SA is designed to trip customer load to restore the balance of supply and demand following a non-credible event.⁶ The current UFLS design in SA is capable of restoring the balance of supply and demand when RoCoF is up to 3 Hz per second.

⁵ Measured at South East substation.

⁶ Non-credible contingency events are defined in the Rules, and broadly refer to events that are very rare and unexpected such as the loss of multiple generating systems / units or multiple lines.

The sudden loss of around 850–900 MW of supply to SA due to the tripping of the Heywood Interconnector resulting in a rapid reduction in the power system frequency.⁷ AEMO analysis has identified that the RoCoF was between 6 and 7 Hz per second. Consequently, UFLS was not able to arrest the frequency decline and as a result the frequency fell to zero. Note that generating units are unable to operate (and are not required to do so) where frequency is below 47 Hz. With the frequency below 47 Hz, generating units subsequently tripped off line resulting in the SA region Black System.

3.5.1 Factors that influence RoCoF

RoCoF is dependent on two factors, the size of the disturbance on the power system and the ability of the power system to resist that disturbance. If the size of the disturbance is increased and/or the ability to resist the disturbance is decreased, the RoCoF will increase.

In this event, the 850–900 MW disturbance resulted in a RoCoF that was greater than all design limits of equipment on the system and above the design limits of the UFLS scheme.

Figure 5 Frequency response and RoCoF during pre-event and event

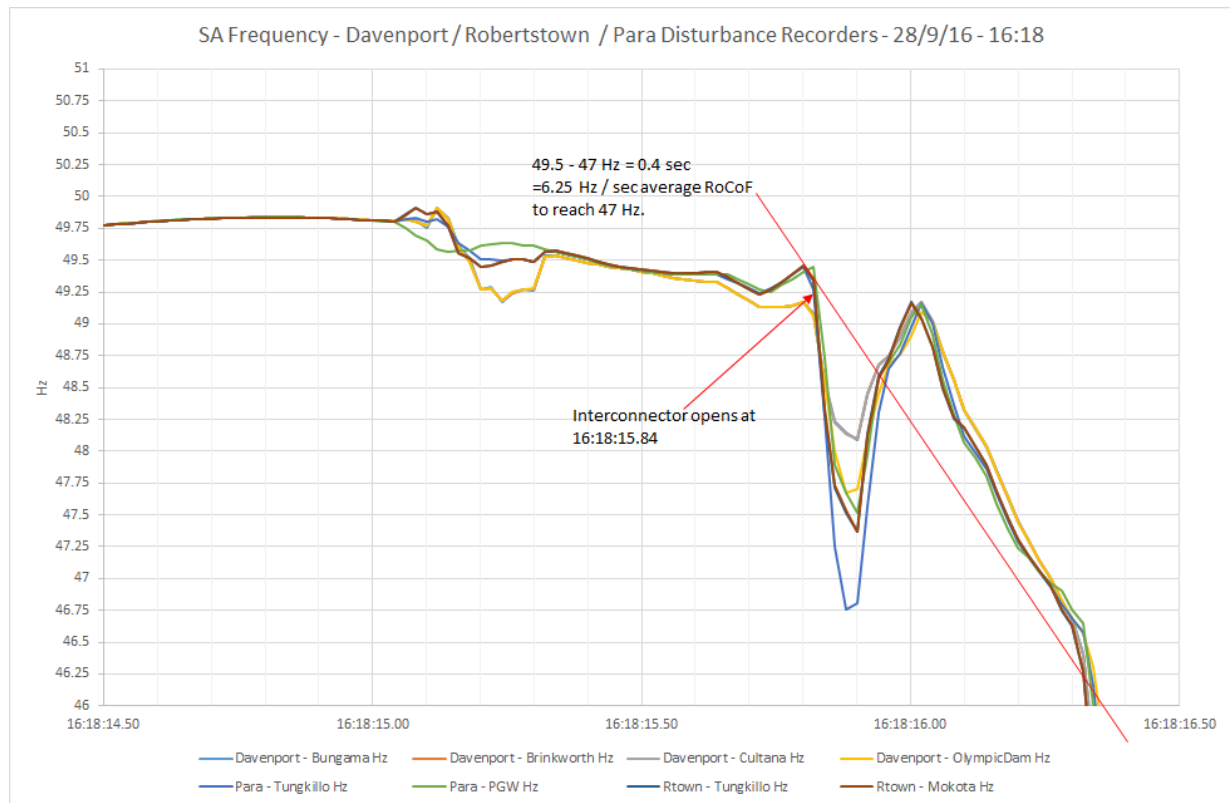

⁷ Murraylink is a DC interconnector. The flow across Murraylink will not change in response to changes in frequency. As such Murraylink cannot assist in restoring the frequency in South Australia after the loss of the Heywood Interconnector.

4. RESTORATION

This sections sets out the roles, responsibilities, and sequence of events relating to the restoration of the SA regional power system and load.

The figure below illustrates the restoration of consumer load following the SA region Black System as a comparison between the forecast load for SA and the load actually supplied.

Figure 6 Comparison of forecast and actual load

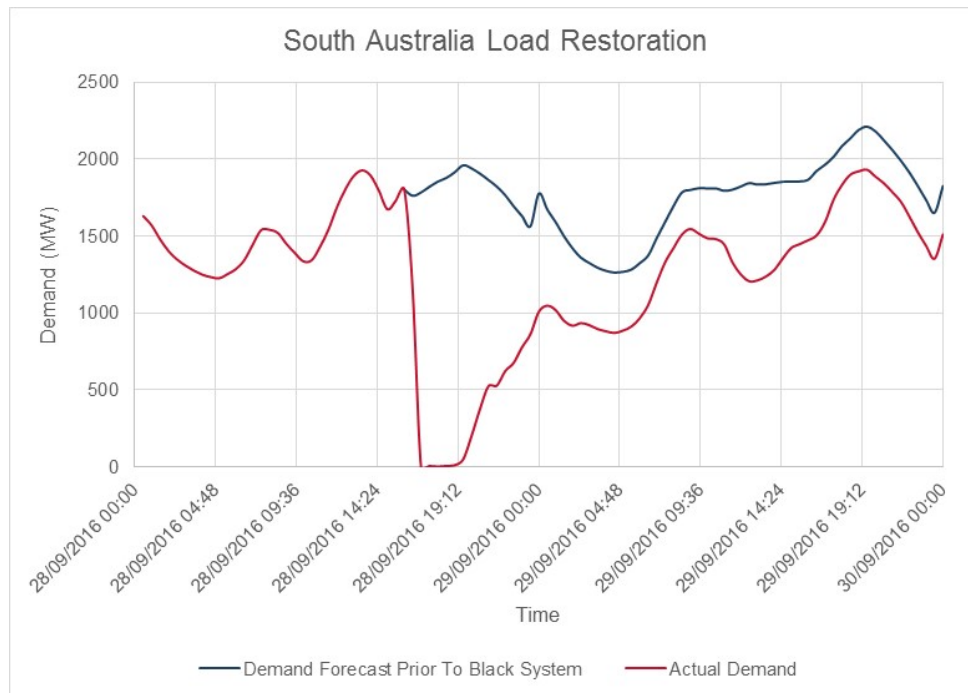

4.1 Roles and responsibilities

AEMO’s role is to co-ordinate the response to a major supply disruption.⁸ This includes:

- Securing the power system.
- Advising participants of the declaration of a Black System.
- Determining, in conjunction with the relevant Network Service Providers (NSPs), the cause of the incident and the status of the power system.
- Developing a restoration strategy in conjunction with the relevant NSPs.
- Activating system restart ancillary services (SRAS) contracts.
- Managing the restoration process.
- Advising market participants of the progress of the restoration.

The NER also requires AEMO to procure SRAS in accordance with the system restart standard⁹ and to develop system restart procedures consistent with the procured SRAS.

The initial task after a major system disturbance is to identify the state of the *power system* and determine the extent of the disturbance. AEMO, in conjunction with the Transmission Network Service Providers (TNSPs) and Generators, determines:

- Which areas of the *power system* are blacked out.
- Which areas of the *power system* are still running in isolation (islanded).

⁸ This includes a Black System event.

⁹ As developed by the Reliability Panel.

- What systems and equipment have been damaged or are otherwise not available.

It may take some time to establish this information, especially if communication has been disrupted.

The risk of proceeding without a clear understanding of the status of the network and what is available could result in safety risks to the public and industry personnel, and damage to the power system and generating units.

Once the system status is confirmed, preparation for system restoration commences. This includes making equipment safe prior to any restoration activities through liaison with transmission and distributions companies and generators.

While AEMO has Regional System Restart Plans in place for all regions, AEMO uses the above information to tailor its Regional System Restart Plan to the specific circumstances of the event.

Once the restoration begins, each step in the process needs to be implemented, assessed and confirmed prior to proceeding to the next stage. This is critical due to the potentially unstable state of the power system.

4.2 Restoration plan

AEMO commenced the restoration process at 16:30.

AEMO planned to use SRAS provider 1 to provide auxiliary supply to the generating units on Torrens Island and at the same time restore the interconnection from Victoria. This was seen as the quickest and safest way to restore supply to South Australia.¹⁰

AEMO initially excluded the northern areas of the state from the restoration process due to extensive damage to transmission assets in the area.

4.3 Restoration sequence of events

The table below provides a summary of the major steps in the restoration process.

Table 5 Load restoration sequence of events

Time	Event
28 September	Initial actions
16:19 (T+44s)	Confirmed SA Black System with ElectraNet.
16:24 (T+6min)	Declared Black System condition for SA region.
16:25 (T+7min)	SA market suspension declared. System separation constraints invoked to ensure accurate inputs for the remainder of the NEM. Automatic Generation Control (AGC) re-configured to stabilise frequency for the remainder of the network.
16:30 (T+12min)	Based on network conditions at this time, AEMO developed a restoration strategy in conjunction with ElectraNet and Generators with SRAS contracts. This included the following restoration plans to proceed in parallel: <ul style="list-style-type: none"> • To establish a corridor from Victoria and supply auxiliary supplies to SA power stations and high priority loads determined by the ElectraNet. • To provide auxiliary supplies to power stations from SRAS Provider 1.
16:32 (T+14min)	Activated SRAS contract with SRAS Provider 1.
	Restart Sequence
16:37 (T+19min)	Requested SRAS Provider 1 unit 1 to come on at minimum load under SRAS.
17:10 (T+52min)	SRAS Provider 1 start initiated and switching commenced.
17:13 (T+55min)	Torrens Island Power Station house load supplied from SRAS Provider 1 unit.
18:43 (T+2h 25min)	Torrens Island house supplies were changed over to supplies from interconnector and SRAS provider 1 unit shutdown to allow connection to the interconnected system.
	Restart from Victoria
17:23 (T+1h 5min)	South East substation was energised from Victoria via the Heywood – South East No.2 275 kV transmission line. South East No.2 275 / 132 kV transformer energised.

¹⁰ Wind farms cannot be used in the initial stages of a power system restoration due to the variable nature of their output.



Time	Event
17:33 (T+1h 15min)	Tailem Bend substation was energised via the South East – Tailem Bend No. 2 275 kV transmission line.
17:52 (T+1h 34 min)	South East SVCs energised.
18:06 (T+1h 48min)	Tungkillo substation was energised via Tailem Bend – Tungkillo 275 kV transmission line.
18:09 (T+1h 51 min)	Para substation was energised via Tungkillo – Para 275 kV transmission line.
18:18 (T+1h 59 min)	Para SVCs 1 and 2 were energised in service to provide voltage support.
18:21 (T+2h 3 min)	Para SVC 1 tripped. South East SVC 1 and 2 tripped
18:28 (T+2h 10min)	Torrens Island East 275 kV busbar energised via Para – Torrens Island 275 kV transmission line.
18:32 (T+2h 14 min)	South East SVC 1 in service.
18:42 (T+2h 24min)	South East – Heywood No.1 transmission line in service.
18:52 (T+2h 34 min)	South East SVC 2 in service.
18:59 (T+2h 41min)	South East – Tailem Bend No.2 275 kV transmission line in service.
19:00 (T+2h 42min)	Transmission corridor from Victoria has now been established through to the Adelaide and CBD area and load restoration commenced. At this point it was decided not to attempt to rebuild the network north of Adelaide due to advice of major transmission network damage.
19:01 (T+2h 43min)	South East – Mt Gambier - Blanche 132 kV transmission lines in service.
19:06 (T+2h 48min)	Tailem Bend - Cherry Gardens - Torrens Island 275 kV transmission lines in service.
19:07 (T+2h 49min)	Para – Magill 275 kV transmission line in service.
19:09 (T+2h 51min)	Cherry Gardens – Happy Valley 275kV transmission line in service.
19:16 (T+2h 58min)	Happy Valley – Magill transmission line in service. This completed a loop between Torrens Island and Para 275 kV.
19:18 (T+3h)	Magill – Burnside 66 kV line in service.
19:29 (T+3h 11min)	Happy Valley – Seacombe – Oakland No.1 and No.2 66 kV lines in service.
19:31 (T+3h 13min)	Para – Parafield Gardens West - Pelican Point – Le Fevre – Torrens Island B 275 kV transmission lines in service.
19:35 (T+3h 17min)	Happy Valley – Morphett Vale East – Cherry Gardens 275 kV transmission line in service.
19:46 (T+3h 28min)	Torrens Island A – Northfield 275 kV transmission line in service.
19:48 (T+3h 30min)	Torrens Island A – Magill 275 kV transmission line in service.
19:50 (T+3h 32min)	Pelican Point gas turbine transformer energised. Auxiliary supply restored to Pelican Point power station.
19:54 (T+3h 36min)	Tungkillo - Mt Barker – Cherry Gardens 275 kV transmission line in service.
19:55 (T+3h 37min)	Quarantine power station units 1-4 in service.
20:06 (T+3h 48min)	Tailem Bend – Mobilong – Murray Bridge / Hahndorf Pumps No.2 132 kV transmission line in service.
20:43 (T+4h 25min)	Magill – East Terrace 275 kV transmission line in service.
20:47 (T+4h 29min)	South East – Snuggery 132 kV transmission line in service.
20:58 (T+4h 40min)	Torrens Island power station A2 generating unit in service.
21:23 (T+5h 5min)	Tailem Bend – Keith – Kincaig 132 kV transmission line in service.
21:34 (T+5h 16min)	Northfield – Kilburn – Torrens Island A 275 kV transmission line in service.
22:02 (T+5h 44min)	Torrens Island power station A4 generating unit in service.
22:05 (T+5h 47min)	Pelican Point power station gas turbine generating unit 1 in service.
22:08 (T+5h 50min)	Snuggery power station in service.
23:10 (T+6h 52min)	Pelican Point power station steam generating unit in service.
23:11 (T+6h 53min)	Para – Robertstown 275 kV transmission line in service.
23:31 (T+7h 31min)	Torrens Island power station B1 generating unit in service.
23:52 (T+7h 34min)	Tungkillo - Robertstown 275 kV transmission line in service.
28 September	Restoration at Port Lincoln
19:07 (T+1d 2h 49min)	Port Lincoln No. 1 generating unit in service.
19:21 (T+1d 3h 3min)	Load restoration commenced in Port Lincoln.

Time	Event
19:33	Port Lincoln No. 2 generating unit in service.
20:00	Port Lincoln No. 3 generating unit in service.
29 September 00:55 (T+1d 8h 37min)	All three Port Lincoln generating units tripped. Multiple attempts to bring online failed.
29 September	Conclusion of Black System condition.
29 September 18:25 (T+2d 2h 7min)	AEMO advised that that a Black System condition in the South Australia region is no longer current. AEMO has given clearance to restore the last load block in South Australia. AEMO notified that the Spot Market will continue to be suspended.

4.4 Load restoration

ElectraNet commenced load restoration in the Adelaide area at 19:00. Load restoration continued based initially on supply from Victoria and then on generation in SA as it became available. By midnight on 28 September 2016 approximately 1,000 MW of load had been restored. This represented 80–90% of the load in SA that was capable of being restored at that time.

Load restoration continued on Thursday 29 September 2016 as transmission supply was restored to some areas in the north.

4.5 Use of SRAS

AEMO has two contracted SRAS services in South Australia. For confidentiality reasons under the contracts, AEMO is unable to identify the providers of these service but will refer to them as “SRAS provider 1” and ‘SRAS provider 2”.

SRAS provider 1

At 16:32, AEMO activated SRAS provider 1, and by 17:13, limited auxiliary supply was made available to the Torrens Island Power Station.

Due to an issue currently under investigation, SRAS provider 1 was unable to supply sufficient capacity to restart any of the Torrens Island Power Station units. The power supplied by SRAS provider 1 was sufficient to supply some of the essential auxiliaries of Torrens Island Power Station, hence expediting restoration of these units by enabling a faster start of the Torrens units when energised by the restoration path from the interconnector.

SRAS provider 2

SRAS provider 2 was not able to provide black start capability due to the damage caused by the storm to its auxiliary diesel units which are necessary for the gas turbine to provide restart capability. This service currently remains unavailable.

Provision of SRAS capability from SRAS provider 2 in the transmission configuration at the time would have had no impact in terms of generation and transmission restoration.

4.6 Interconnection to Victoria

AEMO commenced the restoration of the interconnection to Victoria at 17:23 with the aim of creating a connection through to the Torrens Island to provide additional capability to restart generating units in this area. This commenced after ElectraNet carried out other high priority switching related to storm damage to ensure public safety.

Extensive and complex switching is required to restore the power system between Victoria and Torrens Island in SA. By 18:28, a connection from Victoria to Torrens Island in SA had been established.

Further switching was then commenced to provide support to this initial single path and to re-energise the transmission network in the Adelaide area prior to commencing any load restoration. This was in accordance with the restart plan.

Clearance was given to Torrens Island to restart units at 18:54, with the first unit on line and generating just prior to 21:00.



At around 18:36 Engie advised AEMO that the Pelican Point power station, while not currently bid available in the market, could be made available within four hours. AEMO provide auxiliary supply to Pelican Point by 19:50 and the unit was on line and generating by 22:05.

4.7 Conclusion of Black System event

At 18:25 on Thursday, 29 September 2016, AEMO advised the market that the Black System condition no longer existed and that AEMO had given clearance to restore the last load block in SA. This does not mean all load had been restored, only that sufficient generation or interconnector capacity was available to restore all load as the transmission network was restored. Some customers still remained without supply due to faults on the transmission and distribution networks.

At this time AEMO considered whether or not to resume normal market operation. As AEMO had insufficient information about the original cause of the Black System that led to the market suspension, nor sufficient evident to determine the possibility of the spot market being suspended again in the next 24 hours due to the same cause, AEMO determined the market remain suspended. A market notice was issued to this effect at 18:45 on 29 September 2016.

At 20:39, AEMO notified the market it had received a Ministerial Direction issued by the South Australian Attorney-General pursuant to section 4 of the Essential Services Act 1981. This direction required AEMO to suspend the electricity market in SA until further notice. The market remains suspended as of 4 October 2019.

5. NEXT STEPS

AEMO will conduct a thorough investigation into how each component of the electricity system responded under these circumstances. An overview of those activities and areas for investigation is provided in the table below. Dates for the provision of this information to the market will be confirmed in later reporting.

Table 6 Summary of activities

Area	Analysis to be performed
Detailed sequence of events	This report contains all system incidents that are currently as major contributors to the event and restoration. AEMO will continue its forensic investigation of events on the power system.
Market assessment Report	The impact of the event, and associated market suspension, will be examined and quantified.
Mitigation measures	AEMO will explore potential mitigation measures and develop recommendations for the future.
SRAS	Assessment of the performance of the contracted SRAS providers.
AEMO actions	AEMO will review and report on its actions.
Generator performance	AEMO will assess the performance of generating units against their performance standards.
Network performance	AEMO will assess the performance of the transmission and distribution network performance.
Market impact	AEMO will assess the effectiveness of the procedures and rules associated with market suspension as well as the management of the incident and the restoration of supply.
Long term implications	As part of the Future Power System Security work program, AEMO will examine the implications of this event.

For AEMO to prepare a detailed incident report, the following should be noted:

- Under the Rules, Participants have 20 business days to provide data and information in response to requests from AEMO.
- AEMO will undertake detailed modelling.
- Additional data or information may be requested from Participants following initial analysis and modelling.
- A detailed report including recommendations can be expected to take up to six months considering the complexities of the matters involved.

APPENDIX A. POWER SYSTEM DIAGRAM

Diagram illustrating the status of the South Australian 275 kV transmission network before the event - for clarity lower voltage networks such as 132 kV are not illustrated

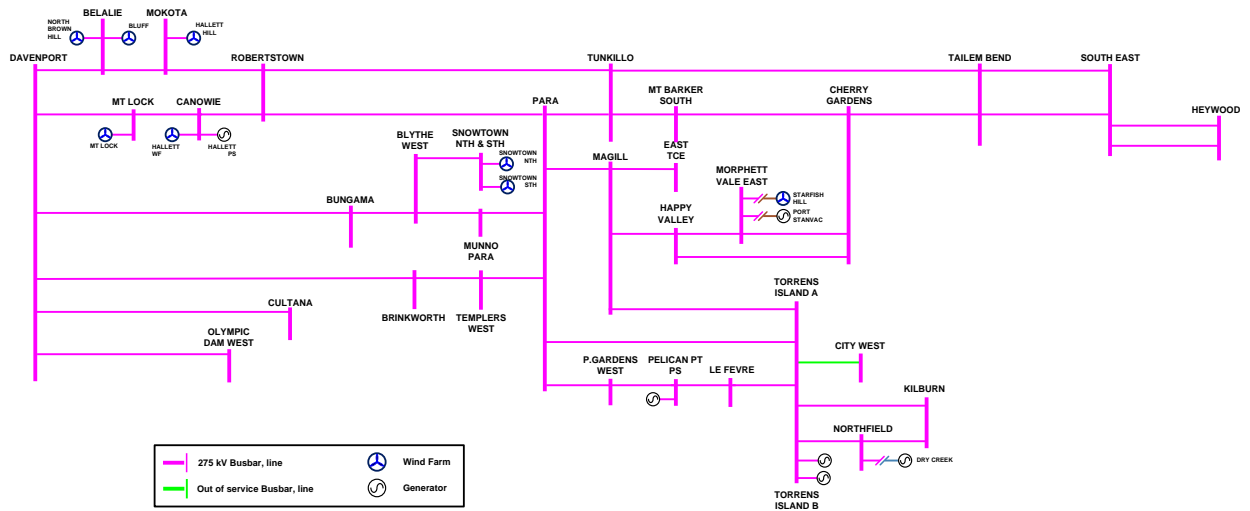

APPENDIX B. WEATHER EVENT REPORT SUPPLIED BY WEATHERZONE

Synoptic Overview

An intense low pressure system brought severe weather to South Australia from Wednesday 28 September until early Friday 30 September, moving into Victoria and southern/south-eastern New South Wales from Thursday 20 September

The low pressure system was especially intense, with sub 974h Pa central pressure as it moved over the Bight on Wednesday 28 September. Associated with this system was a pre-frontal trough and also a cold front, both of which triggered especially severe thunderstorms as they crossed the state of South Australia on 28 September. This thunderstorm activity (including tornadoes) was all connected with the one synoptic scale weather system, so should be considered one event.

The complex system affected large parts of southern and south-eastern Australia, with damaging to destructive winds, widespread thunderstorms, damaging hail and heavy rainfall (leading to flooding) over South Australia in particular.

System progression and impacts

A strong cold front and low pressure system with significant support from a coupled upper trough lagging to the west began to move into the western parts of South Australia early on Wednesday 28 September 2016. As expected from a strong cold front over the region, northerly to north-westerly winds began to strengthen ahead of its passage over the western and central interior of the state, while instability over the same areas was enhanced by a weak low pressure trough extending from the interior of the country, also enhancing moisture availability for thunderstorm development.

Thunderstorms ahead of the system began to develop, spread and intensify over the southern parts of the North West Pastoral with the pre-frontal trough just before 07:00 CST, already observed as widespread over the eastern parts of the West Coast, eastern North West Pastoral and Eastern Eyre Peninsula by 09:00 CST. As storms continued to spread eastward over the peninsulas, interior and metro, the second wave of widespread thunderstorms with the frontal band began to move in over the eastern West Coast and Eyre Peninsula around 13:00 CST, also bringing sustained and damaging south-westerly winds in its wake, along the north-western flank of the deepening low pressure system. The second wave of storms led to widespread thunderstorms, likely destructive wind gusts at times, reported large and damaging hail and cloud-to-ground lightning strikes in excess of 20,000 over large parts of the Eastern Eyre Peninsula, southern Mid North, Yorke Peninsula, Adelaide, and Mt Lofty Ranges.

As the frontal band swept across the state and eventually into Victoria during Wednesday evening, the surface low pressure began to slow down significantly over the open waters to the southwest of Port Lincoln, and deepened its coupling with the upper cut-off low pressure immediately aloft. This coupling and deceleration resulted in sustained damaging winds, persistent showers and lingering thunderstorms over much of the southern and south-eastern parts of the state from midday Wednesday 28 September into the evening of Thursday 29 September.

The coupled low pressure systems slowly tracked into Victoria from late on Thursday 29 September into Friday 30 September, leading to strong and sustained south-westerly wind gusts and showers over south-eastern South Australia into Friday afternoon.

Major effects on South Australia

Wind

Sustained winds ahead of the cold front and low pressure system were primarily from the northwest and west, while subsequent winds were predominantly westerly to south-westerly.

Throughout the duration of the event, long periods of sustained winds of 50–70 km/h were experienced across South Australia, with winds progressively abating from the western interior early on Friday 30 September, but lingering over the south-eastern parts of the state into the afternoon and evening. Some parts endured sustained winds of 60–80 km/h, including the eastern parts of the West Coast, western margin of the Eyre Peninsula, Yorke Peninsula and Mt Lofty Ranges. The evening of Thursday 29 September in particular saw a spike in the sustained wind strength.

Wind gusts, notably more erratic in occurrence and frequency during intense weather systems, were significantly stronger than the reported sustained winds. Peak winds gusts on Wednesday 28 September of 90–110km/h were reported for locations across the state, particularly when noting the wide distribution of location, including Yunta in the North East Pastoral, Snowtown in the Mid North, Cape Willoughby on Kangaroo Island, and Nullarbor on the West Coast.

Destructive wind gusts were a result of severe thunderstorms, which also carry the potential to produce tornadoes. The most likely area and time of severe thunderstorm occurrence was on Wednesday 28 September over the southern parts of the Mid North between 15:00 and 17:00 CST. It is also likely that severe thunderstorms occurred in the broad vicinity of the lower Mid North, northern Yorke Peninsula and Adelaide during or near this period.

On Thursday 29 September, wind gusts of 100–120 km/h were recorded along the eastern West Coast, Lower Eyre Peninsula, Kangaroo Island, Yorke Peninsula, and Mt Lofty Ranges throughout the day. Adelaide itself, together with large parts of all districts to the east of the Metro, reported wind gusts of 80–100km/h throughout the day and into the early hours of Friday 30 September.

Noteworthy wind gust values include:

- Nullarbor (West Coast) - 100km/h at 13:19 CST on 28 September;
- Snowtown (Mid North) - 104km/h at 15:30 CST on 28 September;
- Adelaide (Outer harbour) - 96.3km/h at 06:25 CST on 29 September;
- Neptune Island (West Coast) - 120km/h at 12:30 CST on September 29;
- Cummins (West Coast) - 115km/h at 03:00 CST on September 29;
- Moonta (Yorke Peninsula) - 106km/h at 06:30 CST on September 29.

Storm surge

The sustained nature of winds that resulted from the slow-moving low pressure system, together with a large oceanic fetch, contributed to significant storm surge along coastal areas of South Australia on Thursday 29 September.

Hail, rainfall and flooding

The system as a whole brought 40–60mm over large parts of southern and south-eastern Australia, exceeding 100 mm in parts of south-eastern South Australia and the interior of Victoria.

Large and destructive hail, together with large amounts of small hail were observed with both thunderstorm bands on Wednesday 28 September. In particular, a line of severe thunderstorms moving in a northwest-southeast line from Snowtown to Blanchtown between 15:00 and 17:00 CST would have led to large hail, damaging wind and a tornado near Blyth. More severe thunderstorms were observed to the north of this line during the same period.

Notable South Australia rainfall totals, rates and periods recorded are detailed below:

- Cleve - large hailstones and 14mm of rain in 15min in the early afternoon of Wednesday 28 September;
- Whyalla - 6.8mm/10min late morning on Wednesday 28 September; and



- Elizabeth and Adelaide – 9 mm in an hour late morning/early afternoon on Wednesday 28 September.

Persistent rainfall over a relatively short period of time usually leads to at least minor flooding events. As of Friday 12:00 CST, minor to major flooding was reported for the southern parts of the Mid North, Adelaide and parts of the Mt Lofty Ranges.

Overview of significant warnings before and during the event

Tuesday 27 September

SA

Tue 12:09 CST - Flood Watch for Mid North, Mount Lofty Ranges and Adelaide Metro

Tue 10:20 CST - Gale Warning for Far W/Upper W/Lower W/Central/S Central coasts, Spencer Gulf and Investigator Strait. Strong Wind elsewhere

Tue 16:46 CST - Severe Weather Warning (Damaging Wind) for West Coast, North West Pastoral and Eastern Eyre Peninsula

VIC

Tue 16:49 EST - Severe Weather Warning (Damaging Wind/Heavy Rainfall) for Central, Mallee, South West, Northern Country, North Central and Wimmera

Tue 16:40 EST - Strong Wind Warning for West Coast, Central Coast, Central Gippsland Coast and East Gippsland Coast

Tue 16:40 EST - Strong Wind Warning for West Coast, Central Coast, Central Gippsland Coast and East Gippsland Coast

Wednesday 28 September

SA

Wed 10:10 CST - Severe Storm Warning (Damaging Wind) for Lower Eyre Peninsula, Eastern Eyre Peninsula, West Coast and North West Pastoral

Wed 05:29 CST - Gale Warning for Far W/Upper W/Lower W/Central/S Central/Lower SE/Upper SE coasts & Spencer Gulf. Strong Wind Warning elsewhere

Wed 12:50 CST - Severe Weather Warning (Damaging Winds) for West Coast, Eastern Eyre Peninsula and North West Pastoral

Wed 12:27 CST - Severe Storm Warning (Destructive Wind/Rain/Hail) E Eyre/Yorke Peninsulas, Flinders, Mid N & NE/NW Pastoral. Cancel W Coast & L Eyre

Wed 23:00 CST - Severe Storm Warning (Destructive Wind/Rain/Hail) Adelaide, Mt Lofty, E Eyre/Yorke Peninsulas, Flinders, Mid N, Murraylands & NW/NE Pastoral

VIC

Wed 04:55 EST - Severe Weather Warning (Damaging Wind and Heavy Rain) for the Central, Mallee, South West, Northern Country, North Central and Wimmera

Wed 11:00 EST Severe Weather Warning (Damaging Wind/Heavy Rain) for Central, Mallee, South West, Northern Country, North Central, Wimmera and North East



Thursday 29 September

SA

Thu 13:11 CST - Severe Weather (Damaging Winds/Abnormally High Tides) for all districts excluding Upper/Lower South East

Thu 11:02 CST - Storm Force Wind for Central/S Central coasts, Spencer Gulf & Investigator Strait. Gale Warning elsewhere excl. Upper/Lower South East

NSW

Thu 13:14 EST - Gale Warning for Illawarra Coast, Batemans Coast and Eden Coast. Strong Wind Warning elsewhere

Thu 11:28 EST - Severe Weather Warning (Damaging Winds) for Hunter, Lower Western, Mid North Coast, Central/Northern Tablelands, Riverina & Upper Western

Known reported damage and effects

Damaging winds (destructive at times), heavy rainfall and damaging hail have been reported across South Australia. A tornado was reported in and around Blyth, coincident with the occurrence of a super-cell thunderstorms in that area, which is a necessary precursor to tornado development from thunderstorms. The reported meteorological effects led to widespread power loss for the entire state of South Australia, mainly due to damage to key infrastructure. Restoration was also hampered by the persistence of severe weather throughout Wednesday 28 and Thursday 29 September.

The major impact on Victoria and southern New South Wales has been rainfall leading localised to widespread flooding. This has largely been due to already saturated soils and heavily burdened rivers from above-average September rainfall.

Summary

A complex and significant cold front and low pressure system led to severe weather over large parts of South Australia from Wednesday 28 September to Friday 30 September 2016. Its deceleration during a key period of the passage across South Australia contributed to significant damage to electricity infrastructure, and loss of power to the entire state.

Although widespread thunderstorms affected mostly South Australia, the system led to significant rainfall over Victoria and southern New South Wales, where flooding subsequently continued after earlier rainfall events led to widespread flooding across these areas.

APPENDIX C. WEATHER EVENT REPORT FROM BUREAU OF METEOROLOGY

SOUTH AUSTRALIAN RAIN RADAR ON WEDNESDAY, 28 SEPTEMBER 2016

South Australia
rain radar 12 minutes after system black



South Australia
rain radar 72 minutes after system black

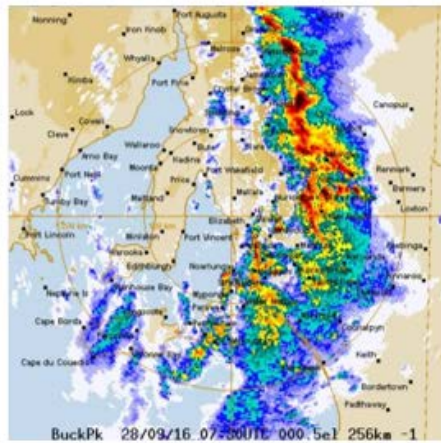

**The images above are from the Bureau of Meteorology.*

APPENDIX D. SA REGION TRANSMISSION SYSTEM

