



---

# Demand Terms in EMMS Data Model

---

~~October 2021~~ June 2024

# Important notice

## **PURPOSE**

AEMO has prepared this document to provide general information about regional demand definitions, as at the date of publication.

## **DISCLAIMER**

This document or the information in it may be subsequently updated or amended. This document does not constitute legal or business advice, and should not be relied on as a substitute for obtaining detailed advice about the National Electricity Law, the National Electricity Rules, or any other applicable laws, procedures or policies. AEMO has made every reasonable effort to ensure the quality of the information in this document but cannot guarantee its accuracy or completeness.

Accordingly, to the maximum extent permitted by law, AEMO and its officers, employees and consultants involved in the preparation of this document:

- make no representation or warranty, express or implied, as to the currency, accuracy, reliability or completeness of the information in this document; and
- are not liable (whether by reason of negligence or otherwise) for any statements or representations in this document, or any omissions from it, or for any use or reliance on the information in it.

## VERSION RELEASE HISTORY

Version	Date	Author	Authorised by	Notes
<a href="#">16.0</a>	<a href="#">03/06/2024</a>	<a href="#">Electricity Market Monitoring</a>		<a href="#">Updated to include IESS changes.</a>
15.0	24/10/2021	Operational Forecasting	Brian Nelson	Updated to include Wholesale Demand Response and general clarifications.
14.0	17/06/2021	Operational Forecasting	Brian Nelson	Updated to clarify when retroactive adjustments are made to Operational Demand.
13.0	31/12/2020	Electricity Market Monitoring	Brian Nelson	Updated due to delayed five-minute settlement start date.
12.0	31/10/2019	Electricity Market Monitoring	Brian Nelson	Modified terminology to incorporate five-minute settlement. Updated exceptions to definition of Operational Demand to exclude non-scheduled diesel generation in South Australia. Minor amendments.
11.0	09/01/2019	Electricity Market Monitoring	Brian Nelson	Updated template, weblinks, footnote and sections where native and operational demand are used.
10.0	03/09/2018	Operational Forecasting	Brian Nelson	Updated exceptions to definition of Operational Demand to include non-scheduled diesel generation in South Australia, following the re-classification of two SA Power Networks diesel facilities from scheduled to non-scheduled.
9.0	18/07/2018	Operational Forecasting	Jonathan Jorgensen	Updated exceptions to definition of Operational Demand to include a non-scheduled generator (Longreach Solar Farm)
8.0	04/06/2018	Operational Forecasting	Nathan White	Updated exceptions to definition of Operational Demand to include non-scheduled generators (Yaloak South Wind Farm and Hughenden Solar Farm).
7.0	06/09/2016	Market and System Change	Nathan White	Updated exceptions to definition of Operational Demand to exclude non-scheduled diesel generation in Tasmania following their de-registration.
6.0	18/05/2016	Market and System Change	Joe Spurio	Updated exceptions to definition of Operational Demand to include non-scheduled diesel generation in Tasmania.
5.0	28/09/2015	Market and System Change	Nathan White	Updated title to reflect full scope of this report. Include exceptions in the calculations of the key demands, add references to Rule clauses when applicable, modify EMMS Data Model, and other minor changes. Updated Table 2 to include omissions and rectify errors.
4.0	10/02/2012	Market Operations and Performance	Brian Nelson	Major revamping to restructure the paper and include the key demands used by AEMO, in addition to the EMMS Data Model items.

---

<b>Version</b>	<b>Date</b>	<b>Author</b>	<b>Authorised by</b>	<b>Notes</b>
<b>3.0</b>	23/12/2009	Market Operations and Performance	Basilisa Choi	Initial creation – minor modifications were made to version 1.0 to add disclaimer and apply AEMO rebranding.

---

# Introduction

## Purpose and scope of this paper

This paper describes the composition, use and publication of the different types of demands and associated terms used in AEMO's Electricity Market Management Systems (EMMS) Data Model for National Electricity Market (NEM) participants or other interested parties. The particular focus of this paper is "as generated" demand, although other demands are defined.

Other organisations such as Network Service Providers or Jurisdictional Planning Bodies (JPBs) might have a different definition for the same terms or associated terminology discussed in this paper. This paper does not delve into the differences.

For definitional purposes, all references to "demand" in this paper equally apply to "consumption"<sup>1</sup>.

## Structure of the paper

The paper is structured as follows:

Section 1 introduces the three types of demand based on where they are measured in the electricity network. It also discusses the three key demands of Native, Operational and Scheduled related to "as generated" demand as used in the NEM.

Section 2 describes the "as generated" demand in the Electricity Market Management System (EMMS), by categorising them into their relevant electricity market processes.

## Assumptions

The following assumptions are made for all demand definitions discussed in this paper.

- All demand definitions are on a regional basis<sup>2</sup>.
- All demands can be expressed as either actual or forecast, unless explicitly stated.
- Scheduled loads mean normally-off scheduled loads<sup>3</sup>. There are currently no normally-on scheduled loads in the NEM.
- If the NEM registration classification of a unit differs from its EMMS classification, this paper only discusses the unit's EMMS classification<sup>4</sup>.

## Convention

EMMS field names are italicised. All key demands that are used throughout the paper have been bolded.

---

<sup>1</sup> For example, AEMO publications refer to both "operational demand" (electrical power, typically in MW) and "operational consumption" (electrical energy, typically in MWh), although the underlying compositional definition is the same. Refer to Operational Consumption and Demand document for more information on the differences between demand and consumption, at [https://www.aemo.com.au/-/media/Files/Electricity/NEM/Planning\\_and\\_Forecasting/Demand-Forecasts/Operational-Consumption-definition.pdf](https://www.aemo.com.au/-/media/Files/Electricity/NEM/Planning_and_Forecasting/Demand-Forecasts/Operational-Consumption-definition.pdf).

<sup>2</sup> Demand in a region that is met by generation within the region and the net interconnector imports into the region.

<sup>3</sup> Normally-on and normally-off scheduled loads are defined in clause 3.8.7(i) and (j) of the National Electricity Rules (NER). Note Wholesale Demand Response is distinct from a normally-on scheduled load.

<sup>4</sup> If a unit is registered as a non-scheduled generating unit but, as a condition of registration, the relevant Registered Participant must comply with some of the obligations of a Scheduled Generator, the unit may need to be treated as a scheduled generating unit in the central dispatch process. This paper refers to such a unit as a scheduled generating unit. For example, Yarwun is registered as a market non-scheduled generating unit but is dispatched as a scheduled generating unit with respect to its dispatch offers, targets and generation outputs. Accordingly, information about Yarwun is reported as scheduled generating unit information.

# Contents

<b>Introduction</b>	<b><u>54</u></b>
<b>1. What is demand?</b>	<b><u>76</u></b>
1.1 Native demand	<u>98</u>
1.2 Operational demand	<u>98</u>
1.3 Scheduled demand	<u>1140</u>
<b>2. Demand terms in EMMS data model</b>	<b><u>1312</u></b>
2.1 Demand Terms in EMMS Data Model used in the central dispatch process	<u>1917</u>
2.2 Demand Terms in EMMS Data Model used in PASA processes	<u>2321</u>
<b>A1. Probability of exceedance demands</b>	<b><u>2523</u></b>
<b>A2. Website publication information</b>	<b><u>2624</u></b>
<b>A3. EMMS table field names for obtaining data for computing EMMS terms</b>	<b><u>2725</u></b>
<b>A4. Examples</b>	<b><u>2926</u></b>
<b>Glossary</b>	<b><u>3229</u></b>

# 1. What is demand?

Demand is the electrical power requirement (in megawatts, or MW) of consumers in a region connected to the electricity network. As shown in Figure 1 below, based on the location of measurement in the electricity network, demand can be broadly classified into:

- "As generated" demand.
- "Sent out" demand.
- "As consumed" demand.

Figure 1 Electricity network topology

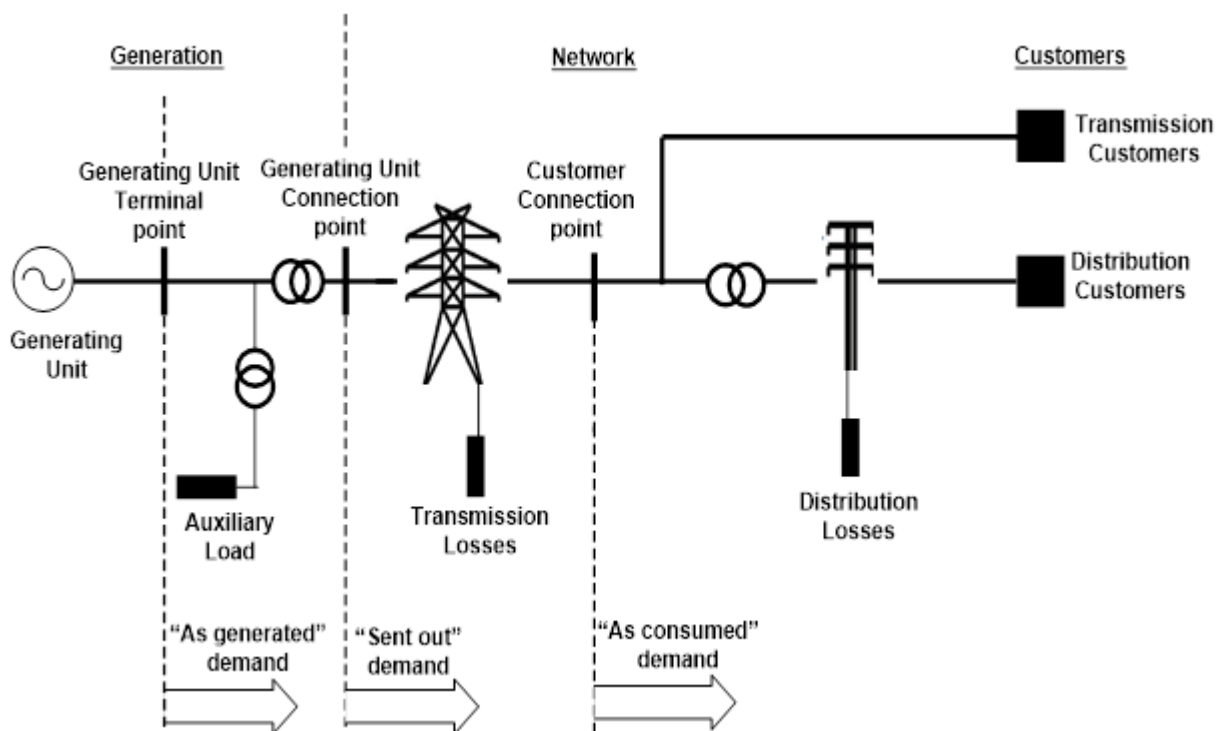

"As consumed" demand or "customer demand" is measured at each customer's connection point and represents the net electrical power consumed at that point. "As consumed" demand measures electricity power supplied to all customers (transmission and distribution) and therefore excludes generating unit auxiliary loads<sup>5</sup> and transmission losses.

"Sent out" demand is measured at each [generating-production](#) unit's connection point and represents the net electrical power output from the [generating-production](#) unit excluding its auxiliary load. [A production unit may be a generating unit or a bidirectional unit.](#) "Sent out" demand therefore comprises:

- "As consumed" demand.
- All electricity transmission losses incurred in delivering the net [generating-production](#) unit output to the bulk electricity customer connection points.

<sup>5</sup> Load used to run a power station. This may include supplies to operate the coal mine as well.

“As generated” demand is measured at each generating-production unit’s terminal point and represents the gross electrical power output from the generating-production unit. “As generated” demand therefore comprises:

- “Sent out” demand.
- The electrical power supplied to all auxiliary loads required to operate the relevant generating-production unit at its “as generated” output.

All demands discussed in this paper from this point are “As generated” demands.

AEMO performs a number of functions and processes that require different types of generating units or loads to be included in the demand calculations. These functional and operational requirements have led AEMO to produce various types of demands defined by composition. In essence, there are three key demands. They are:

- Native demand.
- Operational demand.
- Scheduled demand.

Table 1 provides an overview of the composition of native demand, operational demand, and scheduled demand.

- “Local generation” means power supplied from generators-production units located in the relevant region.
- “Imported generation” means the net power supplied to the relevant region at its inter-regional boundaries.
- “Local scheduled loads” means power consumed by scheduled loads and bidirectional units located in the relevant region.
- “Wholesale Demand Response” (WDR) refers to the reduction in power consumed by dispatching a WDR unit. An X mark in Table 1 indicates the respective demand reduces when WDR is dispatched, while a tick mark indicates the WDR “response” is added back.

**Table 1 Native demand, operational demand and scheduled demand – composition**

Generation source	Local generation				Imported generation	Local demand of scheduled loads <u>and</u> <u>scheduled bidirectional units</u>	Wholesale Demand Response
	Key demands	Scheduled and semi-scheduled <u>generating units and scheduled bidirectional units</u>	Non-scheduled wind/solar generation				
Generation < 30MW			Generation ≥ 30MW	Non-scheduled non-wind/non-solar generation			
Native demand	✓	✓	✓	✓	✓	x	✓
Operational demand	✓	x	✓	x	x	✓	x
Scheduled demand	✓	x	x	x	x	✓	x

The three key demands and the exceptions in calculating these demands are discussed in detail in the following sections.



## 1.1 Native demand

**Native demand** in a region is demand that is met by local scheduled, semi-scheduled, non-scheduled<sup>6</sup>, and exempt generation<sup>7</sup>, by generation from scheduled bidirectional units (BDUs), and by generation imports to the region, excluding the demand of local scheduled loads<sup>8</sup> and scheduled bidirectional units, and including Wholesale Demand Response. **Native demand** only includes generation for which AEMO and the JPBs receive sufficient information.<sup>9</sup>

Figure 2 below shows the composition of **native demand**.

**Figure 2 Native demand**

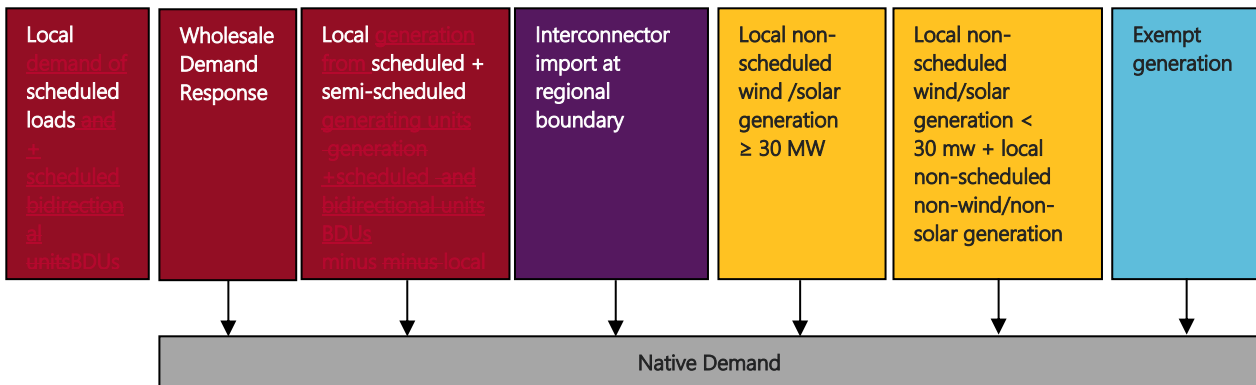

### Where native demand is used

**Native demand** is used as follows.

The 10% and 50% POE seasonal maximum **native demand** forecasts are reported as part of the reliability assessment in Medium Term Projected Assessment of System Adequacy (MTPASA<sup>10</sup>). This is discussed in detail in Section 2.2.2.

## 1.2 Operational demand

**Operational demand** in a region is demand that is met by local scheduled generation, semi-scheduled generation, scheduled bidirectional units, and non-scheduled wind/solar generation of aggregate capacity  $\geq$  30 MW, and by generation imports to the region, excluding the demand of local scheduled loads and scheduled bidirectional units, and including Wholesale Demand Response.

When Wholesale Demand Response (WDR) is dispatched the measurements of the other components of **operational demand** (measured **operational demand**<sup>11</sup>) will decrease by the amount of dispatched WDR. As the amount of dispatched WDR is determined by NEMDE Solver, the forecasts of **operational demand** need to reflect the expected demand before WDR is dispatched. To ensure consistency between forecasts of

<sup>6</sup> This includes all non-scheduled generating units with aggregate capacity greater than 1 MW for which AEMO and JPBs have sufficient data.

<sup>7</sup> Exempt generation refers to generation that is exempt from registration, under Chapter 2 of the NER and in accordance with the "Guide to NEM generator classification and exemption" issued by AEMO: <https://aemo.com.au/en/energy-systems/electricity/national-electricity-market-nem/participate-in-the-market/registration/exemption-from-registering-as-a-generator-in-the-nem>. Typically, this includes generation with a capacity less than 5 MW, or less than 30 MW provided it exports less than 20 GWh in any 12-month period.

<sup>8</sup> A market load classified in accordance to Chapter 2 of the NER as a scheduled load. A market customer submits dispatch bids in relation to scheduled loads.

<sup>9</sup> Native demand does not include the demand met by behind-the-meter generation (e.g. rooftop PV, battery storage). Therefore, native demand reflects the impact of behind-the-meter generation (for example higher rooftop PV generation will result in lower midday native demand).

<sup>10</sup> MTPASA has a daily resolution and forecasts two years ahead. It is a PASA process.

<sup>11</sup> Measured operational demand is field "OPERATIONAL\_DEMAND" in EMMS Data Model, as described in Appendix A2.

**operational demand** and historic values of **operational demand** it is necessary to reconstitute the measured **operational demand** with the estimated actual WDR.

**Operational demand** differs from **native demand** in that it generally excludes demand met by non-scheduled wind/solar generation of aggregate capacity < 30 MW, non-scheduled non-wind/non-solar generation and exempt generation.

The exceptions which are included in the **operational demand** definition are:

- Yarwun (registered as non-scheduled generation but treated as scheduled generation in the EMMS).
- Mortons Lane wind farm, Yaloak South wind farm, Hughenden solar farm, Longreach solar farm (non-scheduled generation < 30 MW but due to power system security reasons AEMO is required to model in network constraints).

**Figure 3 below shows the composition of operational demand.**

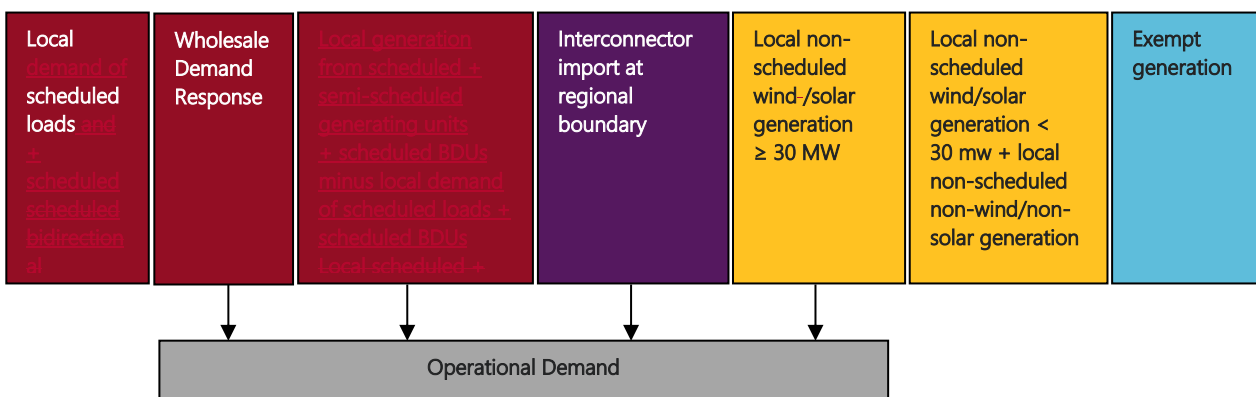

### Wholesale Demand Response

Actual **operational demand** includes the measured **operational demand** reconstituted with estimated actual WDR. The regional actual WDR is estimated either from SCADA telemetry (estimated response against a baseline) provided by each WDR unit, or from the previous interval dispatch target for WDR units with no telemetry. This aggregate WDR estimate is provided in a separate field to the measured **operational demand** through the EMMS data model (see Appendix A2 for **operational demand** data available).

### Operational demand adjustments

From time to time, retroactive adjustments to actual **operational demand** may be required. These MW adjustments represent AEMO’s firmest estimate of counterfactual **operational demand**, using information available immediately after the event.

**Operational demand** adjustments include:

- Activated RERT; and
- Involuntary load shedding that occurred as a result of a NER 4.8.9 instruction for load shedding from AEMO

**Operational demand** adjustments exclude all other events, such as:

- Other AEMO directions
- Under Frequency Load Shedding
- Operation of Special Protection Schemes
- Virtual Power Plants / Demand Response (WDR is accounted for separately)
- System Black
- Industrial load outages

Retroactive **operational demand** adjustments are provided in a separate field to the measured **operational demand** through the EMMS data model (see Appendix A2 for **operational demand** data available).

### Where operational demand is used

**Operational demand** is used as follows.

- For public reporting of electricity market and power system operation: for example, the minimum and maximum measured **operational demand** records reported to the media for reporting on market and power system incidents.
- As a basis for calculating the forecast demand used in Pre-dispatch<sup>12</sup>, Pre-dispatch Projected Assessment of System Adequacy (PDPASA<sup>13</sup>), Short Term Projected Assessment of System Adequacy (STPASA<sup>14</sup>) and Medium Term Projected Assessment of System Adequacy (MTPASA) processes (discussed in Section 2.1.2 under Total Demand in Pre-dispatch, Section 2.2.1 for PDPASA and STPASA and Section 2.2.2 for MTPASA).
- Actual values of **operational demand** to a half-hourly resolution, are published on the AEMO website<sup>15</sup> for all regions in the NEM (see Appendix A2 for **operational demand** data available).
- AEMO publishes 10%, 50% and 90% probability of exceedance<sup>16</sup> (POE) seasonal maximum<sup>17</sup> **operational demand** forecasts for three probable scenarios for summer and winter over a 20-year timeframe for all NEM regions. These forecasts are used for Integrated System Plan<sup>18</sup>, Electricity Statement of Opportunities<sup>19</sup> and Energy Adequacy Assessment Projection<sup>20</sup>.

## 1.3 Scheduled demand

**Scheduled demand** in a region is demand that is met by local scheduled and semi-scheduled generation, [scheduled bidirectional units](#), and by generation imports to the region. **Scheduled demand** differs from the other key demands in that it excludes the demand met by non-scheduled (wind/solar and non-wind/non-solar) generation and exempt generation and Wholesale Demand Response, and includes the demand of local scheduled loads [and scheduled bidirectional units](#). When Wholesale Demand Response is dispatched **scheduled demand** will decrease by the amount of dispatched WDR.

The exceptions are Tumut 3 pumps (registered as non-scheduled loads but treated as scheduled loads in the EMMS) which are included.

Figure 4 below shows the composition of **scheduled demand**.

<sup>12</sup> Pre-dispatch has a 30-minute resolution and forecasts up to 40 hours ahead. It is a central dispatch process.

<sup>13</sup> PDPASA has a 30-minute resolution and forecasts up to 40 hours ahead. It is a PASA process.

<sup>14</sup> STPASA has a 30-minute resolution and forecasts eight days ahead. It is a PASA process.

<sup>15</sup> Available under section "Operational Demand" at: <https://www.aemo.com.au/energy-systems/electricity/national-electricity-market-nem/data-nem/operational-demand-data>.

<sup>16</sup> The 10%, 50%, and 90% POE demands are defined in Appendix A1.

<sup>17</sup> Maximum demand refers to the highest amount of electrical power delivered over a defined period (day, week, month, season or year).

<sup>18</sup> Integrated System Plan (ISP) at: <https://www.aemo.com.au/Electricity/National-Electricity-Market-NEM/Planning-and-forecasting/Integrated-System-Plan>

<sup>19</sup> NEM Electricity Statement of Opportunities (ESOO) at: <https://www.aemo.com.au/Electricity/National-Electricity-Market-NEM/Planning-and-forecasting/NEM-Electricity-Statement-of-Opportunities>

<sup>20</sup> Energy Adequacy Assessment Projection (EAAP) at: <https://www.aemo.com.au/Electricity/National-Electricity-Market-NEM/Planning-and-forecasting/Energy-Adequacy-Assessment-Projection>

Figure 4 Scheduled demand

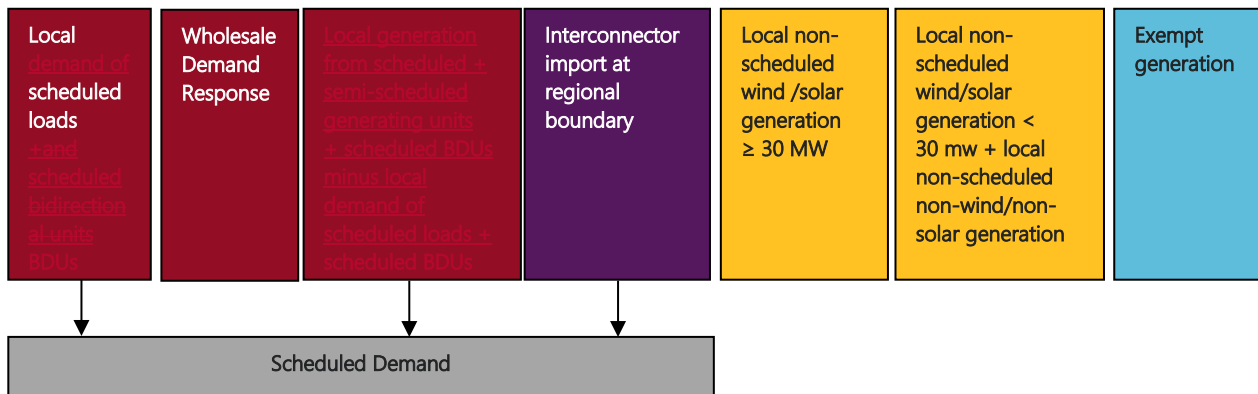

### Where scheduled demand is used

Scheduled demand is used as follows.

As a basis for calculating the forecast demand used in the central dispatch process to determine regional prices and dispatch targets for scheduled and semi-scheduled generating units and Market Network Service Providers (MNSPs).

Publication of **scheduled demand** values (*InitialSupply* and *ClearedSupply*) to the EMMS data model is discussed in Section 2.1.1.

## 2. Demand terms in EMMS data model

This section explains the components of the various demand-related terms published by AEMO that are part of the EMMS Data Model, and their inter-relationship. All the EMMS Data Model terms are defined using EMMS-specific field names.

The EMMS Data Model terms can be used to calculate the key demands discussed in Section 2.

Table 2 explains the components of the EMMS Data Model terms published by AEMO.

Appendix A2 lists the file names for each of the published EMMS Data Model terms in Table 2.

**Table 2 Components of EMMS data model terms published by AEMO**

EMMS data model term			Forecast type	Scheduled generation and scheduled bidirectional unit generation	Semi-scheduled generation	Non-scheduled (wind/solar >=30 MW) <sup>A</sup>	Non-scheduled (non-wind/non-solar or wind/solar <=30 MW) <sup>B</sup>	Wholesale Demand Response <sup>C</sup>	Exempt generation	Scheduled loads and scheduled bidirectional unit demand	Interconnector import at RRN	Allocated interconnector losses <sup>D</sup>	Aggregate dispatch error and forecast demand change
Package	Table	Field											
DISPATCH	DISPATCHREGIONSUM	CLEAREDSUPPLY	50% POE	✓	✓	x	x	x	x	✓	✓	✓	✓
DISPATCH	DISPATCHREGIONSUM	INITIALSUPPLY	Actual	✓	✓	x	x	x	x	✓	✓	✓	x
DISPATCH	DISPATCHREGIONSUM	TOTALDEMAND	50% POE	✓	✓	x	x	✓	x	x	✓	x	✓
DISPATCH	DISPATCHREGIONSUM	DEMAND_AND_NONSCHE DGEN	50% POE	✓	✓	✓	✓	x	x	✓	✓	✓	✓
PRE_DISPATCH	PREDISPATCHREGIONSUM	CLEAREDSUPPLY	50% POE	✓	✓	x	x	x	x	✓	✓	✓	x
PRE_DISPATCH	PREDISPATCHREGIONSUM	INITIALSUPPLY	Actual	✓	✓	x	x	x	x	✓	✓	✓	x
PRE_DISPATCH	PREDISPATCHREGIONSUM	TOTALDEMAND	50% POE	✓	✓	x	x	✓	x	x	✓	x	x
PRE_DISPATCH	PREDISPATCHREGIONSUM	DEMAND_AND_NONSCHE DGEN	50% POE	✓	✓	✓	x	x	x	✓	✓	✓	x
P5MIN <sup>E</sup>	P5MIN_REGIONSOLUTION	CLEAREDSUPPLY	50% POE	✓	✓	x	x	x	x	✓	✓	✓	✓ <sup>F</sup>
P5MIN	P5MIN_REGIONSOLUTION	INITIALSUPPLY	Actual	✓	✓	x	x	x	x	✓	✓	✓	x
P5MIN	P5MIN_REGIONSOLUTION	TOTALDEMAND	50% POE	✓	✓	x	x	✓	x	x	✓	x	✓ <sup>F</sup>
P5MIN	P5MIN_REGIONSOLUTION	DEMAND_AND_NONSCHE DGEN	50% POE	✓	✓	✓	✓	x	x	✓	✓	✓	✓ <sup>F</sup>

EMMS data model term			Forecast type	Scheduled generation and scheduled bidirectional unit generation	Semi-scheduled generation	Non-scheduled (wind/solar >=30 MW) <sup>A</sup>	Non-scheduled (non-wind/non-solar or wind/solar <=30 MW) <sup>B</sup>	Wholesale Demand Response <sup>C</sup>	Exempt generation	Scheduled loads and scheduled bidirectional unit demand	Interconnector import at RRN	Allocated interconnector losses <sup>D</sup>	Aggregate dispatch error and forecast demand change
Package	Table	Field											
DEMAND_FORECASTS	PERDEMAND	RESDEMAND	50% POE	✓	✓	✗	✗	✓	✗	✗	✓	✓	✗
DEMAND_FORECASTS	PERDEMAND	DEMAND10PROBABILITY	10% POE	✓	✓	✗	✗	✓	✗	✗	✓	✓	✗
DEMAND_FORECASTS	PERDEMAND	DEMAND90PROBABILITY	90% POE	✓	✓	✗	✗	✓	✗	✗	✓	✓	✗
DEMAND_FORECASTS	DEMANDOPERATIONALACTUAL	OPERATIONAL_DEMAND <sup>G</sup>	Actual	✓	✓	✓	✗	✗	✗	✗	✓	✓	✗
DEMAND_FORECASTS	DEMANDOPERATIONALACTUAL	OPERATIONAL_DEMAND <sup>G</sup> + WDR_ESTIMATE <sup>H</sup>	Actual	✓	✓	✓	✗	✓	✗	✗	✓	✓	✗
DEMAND_FORECASTS	DEMANDOPERATIONALFORECAST	OPERATIONAL_DEMAND_POE10	10% POE	✓	✓	✓	✗	✓	✗	✗	✓	✓	✗
DEMAND_FORECASTS	DEMANDOPERATIONALFORECAST	OPERATIONAL_DEMAND_POE50	50% POE	✓	✓	✓	✗	✓	✗	✗	✓	✓	✗
DEMAND_FORECASTS	DEMANDOPERATIONALFORECAST	OPERATIONAL_DEMAND_POE90	90% POE	✓	✓	✓	✗	✓	✗	✗	✓	✓	✗
PDPASA	PDPASA_REGIONSOLUTION	DEMAND50	50% POE	✓	✓	✗	✗	✓	✗	✗	✓	✓	✗
PDPASA	PDPASA_REGIONSOLUTION	DEMAND10	10% POE	✓	✓	✗	✗	✓	✗	✗	✓	✓	✗
PDPASA	PDPASA_REGIONSOLUTION	DEMAND90	90% POE	✓	✓	✗	✗	✓	✗	✗	✓	✓	✗
PDPASA	PDPASA_REGIONSOLUTION	DEMAND_AND_NONSCHE DGEN	50% POE	✓	✓	✓	✗	✗	✗	✗	✓	✓	✗

EMMS data model term			Forecast type	Scheduled generation and scheduled bidirectional unit generation	Semi-scheduled generation	Non-scheduled (wind/solar >=30 MW) <sup>A</sup>	Non-scheduled (non-wind/non-solar or wind/solar <=30 MW) <sup>B</sup>	Wholesale Demand Response <sup>C</sup>	Exempt generation	Scheduled loads and scheduled bidirectional unit demand	Interconnector import at RRN	Allocated interconnector losses <sup>D</sup>	Aggregate dispatch error and forecast demand change
Package	Table	Field											
STPASA_SOLUTION	STPASA_REGIONSOLUTION	DEMAND50	50% POE	✓	✓	✗	✗	✓	✗	✗	✓	✓	✗
PDPASA	PDPASA_REGIONSOLUTION	DEMAND50	50% POE	✓	✓	✗	✗	✓	✗	✗	✓	✓	✗
PDPASA	PDPASA_REGIONSOLUTION	DEMAND10	10% POE	✓	✓	✗	✗	✓	✗	✗	✓	✓	✗
PDPASA	PDPASA_REGIONSOLUTION	DEMAND90	90% POE	✓	✓	✗	✗	✓	✗	✗	✓	✓	✗
PDPASA	PDPASA_REGIONSOLUTION	DEMAND_AND_NONSCHE DGEN	50% POE	✓	✓	✓	✗	✓	✗	✗	✓	✓	✗
STPASA_SOLUTION	STPASA_REGIONSOLUTION	DEMAND50	50% POE	✓	✓	✗	✗	✓	✗	✗	✓	✓	✗
STPASA_SOLUTION	STPASA_REGIONSOLUTION	DEMAND10	10% POE	✓	✓	✗	✗	✓	✗	✗	✓	✓	✗
STPASA_SOLUTION	STPASA_REGIONSOLUTION	DEMAND90	90% POE	✓	✓	✗	✗	✓	✗	✗	✓	✓	✗
STPASA_SOLUTION	STPASA_REGIONSOLUTION	DEMAND_AND_NONSCHE DGEN	50% POE	✓	✓	✓	✗	✓	✗	✗	✓	✓	✗
MTPASA	MTPASA_REGIONRESULT	DEMAND (POE 50)	50% POE	✓	✓	✗	✗	✓	✗	✗	✓	✓	✗
MTPASA	MTPASA_REGIONRESULT	DEMAND (POE 10)	10% POE	✓	✓	✗	✗	✓	✗	✗	✓	✓	✗
MTPASA	MTPASA_REGIONSUMMARY	NATIVEDEMAND (POE 10)	10% POE	✓	✓	✓	✓	✓	✓	✗	✓	✓	✗
MTPASA	MTPASA_REGIONSUMMARY	NATIVEDEMAND (POE 50)	50% POE	✓	✓	✓	✓	✓	✓	✗	✓	✓	✗



EMMS data model term			Forecast type	Scheduled generation and scheduled bidirectional unit generation	Semi-scheduled generation	Non-scheduled (wind/solar >=30 MW) <sup>A</sup>	Non-scheduled (non-wind/non-solar or wind/solar <=30 MW) <sup>B</sup>	Wholesale Demand Response <sup>C</sup>	Exempt generation	Scheduled loads and scheduled bidirectional unit demand	Interconnector import at RRN	Allocated interconnector losses <sup>D</sup>	Aggregate dispatch error and forecast demand change
Package	Table	Field											
<b>HISTORICAL TABLES</b>	TRADINGREGIONSUM <sup>H</sup>	CLEARDSUPPLY	50% POE	✓	✓	x	x	N/A <sup>I</sup>	x	✓	✓	✓	✓
<b>HISTORICAL TABLES</b>	TRADINGREGIONSUM	INITIALSUPPLY	Actual	✓	✓	x	x	N/A <sup>I</sup>	x	✓	✓	✓	x
<b>HISTORICAL TABLES</b>	TRADINGREGIONSUM	TOTALDEMAND	50% POE	✓	✓	x	x	N/A <sup>I</sup>	x	x	✓	x	✓
<b>HISTORICAL TABLES</b>	TRADINGREGIONSUM	DEMAND_AND_NONSCHE DGEN	50% POE	✓	✓	✓	✓	N/A <sup>I</sup>	x	✓	✓	✓	✓

- A. Exceptions are Mortons Lane wind farm, Yaloak South wind farm, Hughenden solar farm, and Longreach solar farm, all of which are included in this group as significant non-scheduled generation.
- B. Non-scheduled (non-wind/non-solar or wind/solar <=30 MW) generation is not forecasted, and therefore not generally included. The exception is the DEMAND\_AND\_NONSCHE DGEN field in Dispatch and 5MPD, where the aggregate actual measured generation of those units (that provide telemetry to AEMO) is assumed to be constant and included in that field for those processes only. The DEMAND\_AND\_NONSCHE DGEN field is not used in the central dispatch process.
- C. Wholesale Demand Response (WDR) units are normally-on loads that reduce consumption when dispatched. An X mark in this table indicates the respective demand reduces when WDR is dispatched, while a tick mark indicates the WDR “response” is added back.
- D. The MW losses incurred as a result of the flow across an interconnector can be proportionally allocated to the two regions connected by the interconnector using a pre-determined factor. This proportional allocation of the interconnector loss to a region is referred to as the region’s allocated interconnector loss. It signifies the losses on the interconnector between the region boundary and the Regional Reference Node (RRN).
- E. The package P5MIN contains data for 5MPD.
- F. The 5MPD solver determines forecast demand changes for each interval, by applying the relevant historical average percentage demand change profile to the previous dispatch run’s forecast total demand.
- G. OPERATIONAL\_DEMAND field in DEMANDOPERATIONALACTUAL table is the measured operational demand, with WDR\_ESTIMATE field not added back
- H. This row represents the sum of the OPERATIONAL\_DEMAND field and WDR\_ESTIMATE field. See Appendix A2 for more information on those fields.
- I. The table TRADINGREGIONSUM included data for trading intervals. Data in the trading interval tables are averages of the data in the six dispatch intervals of the relevant trading interval. The TRADINGREGIONSUM table stopped being populated from 1 October 2021, as stated in the EMMS Release Schedule and Technical Specification – 5MS Dispatch and Operations July 2019.

## Forecast type

Forecast type	Description
<b>Actual</b>	Measured value aggregated from Supervisory Control and Data Acquisition (SCADA) based metering with substitution for bad data where available, plus an estimate of Wholesale Demand Response where applicable.
<b>50% POE</b>	Forecast value with a 50% probability of exceedance. Often referred to as the most probable forecast
<b>10% POE</b>	Forecast value with a 10% probability of exceedance.
<b>90% POE</b>	Forecast value with a 90% probability of exceedance.

The terms used in the central dispatch and Projected Assessment of System Adequacy (PASA) processes are discussed further in Sections 2.1 and 2.2 below.

## 2.1 Demand Terms in EMMS Data Model used in the central dispatch process

The central dispatch process comprises Dispatch<sup>21</sup>, Pre-dispatch, and Five-minute Pre-dispatch (5MPD<sup>22</sup>). The main EMMS Data Model demand terms used in the central dispatch process are<sup>23</sup>:

- Initial supply.
- Cleared supply.
- Total demand.

Figure 5 below provides an overview of the composition and relationship between Initial Supply, Cleared Supply and Total Demand in Dispatch.

**Figure 5 Initial Supply, Cleared Supply and Total Demand**

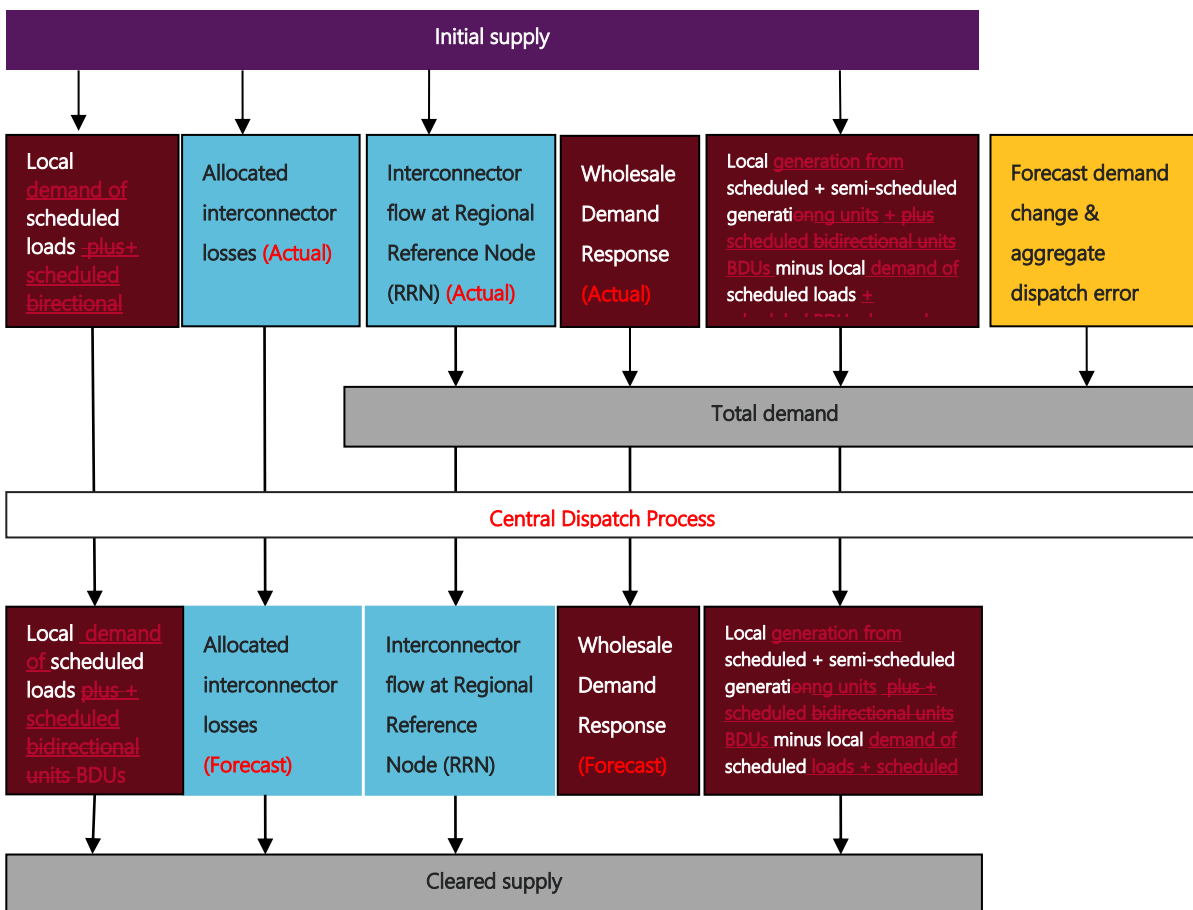

For 5MPD and Pre-dispatch, the composition and relationship between Initial Supply, Cleared Supply and Total Demand are similar in principle to those in Dispatch. Initial Supply, Cleared Supply and Total Demand are discussed further in Sections 2.1.1 and 2.1.2. The relationship of Dispatched Generation to Total Demand and Cleared Supply is discussed in Section 2.1.3 using a Regional Energy Balance Equation.

<sup>21</sup> Dispatch has a five-minute resolution and it forecasts five minutes ahead.

<sup>22</sup> 5MPD has a five-minute resolution and it forecasts one hour ahead.

<sup>23</sup> Table 2 also defines the demand term DEMAND\_AND\_NONSCHEDGEN, however it is not mentioned here as it is not used by the central dispatch process.

## 2.1.1 Cleared Supply and Initial Supply

Initial Supply and Cleared Supply relate to **scheduled demand**. Initial Supply is actual **scheduled demand** measured or estimated at the beginning of an interval. Cleared Supply is forecast **scheduled demand** to be met at the end of the interval. Initial Supply is one of the inputs to the central dispatch process used to calculate Cleared Supply.

### EMMS Relationships

The EMMS specific definitions for Initial Supply and Cleared Supply are given below.

Initial Supply is the sum, at the start of each interval, of generation from all scheduled and semi-scheduled generating units within the region plus the net interconnector flow<sup>24</sup> into the region (as measured at the inter-regional boundary<sup>25</sup>).

Cleared Supply is the sum of the dispatch targets for all scheduled and semi-scheduled generating units within the region plus the net target interconnector flow<sup>26</sup> into the region.

The formulae for calculation of *InitialSupply* and *ClearedSupply* using the EMMS field names (italicised) are provided in Table 3.

**Table 3 Formula for InitialSupply and ClearedSupply**

EMMS Field Name	Process	Formula
<i>InitialSupply</i>	Dispatch, Pre-dispatch, 5MPD	<i>InitialSupply</i> = Sum of <u>generation</u> <i>InitialMW</i> Over all Regional Scheduled and Semi-scheduled generating units + <u>Scheduled BDUs</u> + Net <i>MeteredMWFlow</i> into the Region Over all Interconnectors connected to the region
<i>ClearedSupply</i>	Dispatch, Pre-dispatch, 5MPD	<i>ClearedSupply</i> = Sum of <u>generation</u> <i>TotalCleared</i> Over all Regional Scheduled and Semi-scheduled generating units + <u>Scheduled BDUs</u> + Net <i>MWFlow</i> into the Region Over all Interconnectors connected to the region

In Dispatch, *InitialMW* and *MeteredMWFlow* are actual metered values (i.e. SCADA values). In Pre-dispatch and 5MPD, *InitialMW* and *MeteredMWFlow* are actual metered values only in the first interval and in subsequent intervals these values are based on the targets of the previous interval.

To obtain the data required for calculating *InitialSupply* and *ClearedSupply* using the formulae provided in Table 3, refer to Appendix A3 for information on relevant tables and field names in the EMMS Data Model.

Examples 1 and 2 in Appendix A4 compare manually calculated *InitialSupply* and *ClearedSupply* values using the formulae provided in Table 3 to the published values (calculated by the NEM systems) for a selected trading interval<sup>27</sup>.

<sup>24</sup> The net actual interconnector flow into the region, computed over all interconnectors connected to the region, is determined by deducting the exports out of the region from the imports into the region.

<sup>25</sup> Interconnector flow as measured at inter-regional boundary

= Interconnector flow at Regional Reference Node (RRN) + Allocated Interconnector Losses.

<sup>26</sup> The net target interconnector flow into the region, computed over all interconnectors connected to the region, is determined by deducting the export targets out of the region from the import targets into the region.

<sup>27</sup> The interval was chosen when a scheduled normally-off load was operating.

## 2.1.2 Total Demand

Total Demand is the underlying forecast demand at the Regional Reference Node (RRN) that is met by local generation from scheduled and semi-scheduled generating units and on-scheduled BDUs and plus interconnector imports, excluding the local demand of local-scheduled loads and scheduled BDUs and the allocated interconnector losses, but including the demand met by Wholesale Demand Response.

Total Demand is calculated by the NEM Dispatch Engine (NEMDE) and is used as the launch point for the central dispatch process which performs the regional price calculations in Dispatch, Pre-dispatch and 5MPD, and determines dispatch targets for generating units.

### EMMS Relationships

The EMMS specific definitions for Total Demand in Dispatch, Pre-dispatch, and 5MPD are discussed in this section.

In Dispatch and the first interval of 5MPD, Total Demand is calculated by:

- summing the actual generation values of all scheduled and semi-scheduled generating units and scheduled BDUs within the region plus the net actual interconnector flow into the region
- minus actual demand of scheduled loads and scheduled BDUs within the region and the estimated actual of allocated interconnector losses
- plus actual<sup>28</sup> Wholesale Demand Response for all WDR units within the region
- plus the *DemandForecast*<sup>29</sup> and *AggregateDispatchError*<sup>30</sup>.

The actual values are obtained from Supervisory Control And Data Acquisition (SCADA) telemetry. @

For all subsequent intervals of 5MPD, the *AggregateDispatchError* (ADE)<sup>28</sup> is zero and the Total Demand is calculated by adding the forecast demand change<sup>31</sup> to the Total Demand of the previous interval.

In Pre-dispatch, Total Demand is computed from a 50% POE demand derived from a forecast **operational demand** calculated by AEMO's demand forecasting system (discussed in Section 2.2.1). To calculate the 50% POE demand in Pre-dispatch, the demand met by significant non-scheduled wind/solar generation (generally  $\geq 30$  MW) is deducted from the forecast **operational demand**. This 50% POE demand is referred to as *ResDemand* in the EMMS Data Model. The *ResDemand* is adjusted to remove the allocated interconnector losses to determine the Total Demand at the Regional Reference Node (RRN).

The formulae for calculation of Total Demand using EMMS field names is provided in Table 4.

---

<sup>28</sup> In dispatch, the regional actual Wholesale Demand Response (WDR) is estimated either from SCADA telemetry (estimated response against a baseline) provided by each WDR unit, or from the previous dispatch target for WDR units with no telemetry.

<sup>29</sup> The *Demand Forecast* is a 5-minute demand adjustment (Offset) that attempts to relate the demand at the beginning of a dispatch interval (*Initial Supply*) to the demand at the end (*Cleared Supply*) of the trading interval. From 1 October 2021 the National Electricity Amendment (Five Minute Settlement) Rule 2017 No.15, in conjunction with the National Electricity Amendment (Delayed implementation of five minute and global settlement) Rule 2020 No.10, changes the definition of a dispatch interval to a trading interval, but it will still be five minutes long.

<sup>30</sup> *Aggregate Dispatch Error* is used by NEMDE to account for non-conformance (from dispatch targets) of dispatched generating units that are not enabled for Regulation Frequency Control. The ADE is determined from within the NEM Energy Management System (EMS) and is passed to NEMDE prior to each dispatch run.

<sup>31</sup> The 5MPD solver determines forecast demand changes for each interval, by applying relevant historical average percentage demand change profile to the previous dispatch run's forecast total demand.

**Table 4 Formulae for TotalDemand**

EMMS Field Name	Process	Formula
TotalDemand	Dispatch	$TotalDemand =$ $Sum\ of\ InitialMW_{Over\ all\ Regional\ Scheduled\ and\ Semi-scheduled\ generating\ units}$ $- Sum\ of\ InitialMW_{Over\ all\ Regional\ Scheduled\ Loads}$ $+ Sum\ of\ InitialMW_{Over\ all\ Regional\ Scheduled\ BDUs\ (where\ positive\ values\ represent\ generation\ and\ negative\ values\ represent\ demand)}$ $+ Sum\ of\ InitialMW_{Over\ all\ Regional\ Wholesale\ Demand\ Response\ units}$ $+ Net\ MeteredMWFlow\ into\ the\ Region_{Over\ all\ Interconnectors\ connected\ to\ the\ region}$ $- Total\ Allocated\ Interconnector\ Losses$ $+ DemandForecast + AggregateDispatchError\ (ADE)$ <p>where:</p> $Allocated\ Interconnector\ Losses$ $= Sum\ (MWLosses\ x\ FromRegionLossShare^A)_{Over\ all\ Interconnectors\ connected\ to\ the\ region}$
	5MPD	<p>Same as Dispatch for first interval, then:</p> $TotalDemand_{DI} = TotalDemand_{DI-1} + DemandForecast_{DI}$
	Pre-dispatch	$TotalDemand = ResDemand - Allocated\ Interconnector\ Losses$ <p>where:</p> $Allocated\ Interconnector\ Losses$ $= Sum\ (MWLosses\ x\ FromRegionLossShare^A)_{Over\ all\ Interconnectors\ connected\ to\ the\ region}$ <p>The components of ResDemand are provided in Table 2.</p>

A. *FromRegionLossShare* is a static factor (for each interconnector) that allocates the MW losses on the interconnector to the 2 regions that are connected by it. If the subject region is the notional FromRegion, *FromRegionLossShare* is used. If the subject region is the notional ToRegion, "1- *FromRegionLossShare*" should be used. For more information regarding the "Treatment of Loss Factors", please refer to the document on AEMO's website at: <https://aemo.com.au/en/energy-systems/electricity/national-electricity-market-nem/market-operations/loss-factors-and-regional-boundaries>.

To obtain the data required for calculating Total Demand using the formulae provided in Table 4, refer to Appendix A3 for information on relevant tables and field names in the EMMS Data Model.

Example 3 in Appendix A4 compares manually calculated Total Demand value using the formulae provided in Table 4 to the published value (calculated by the NEM systems) for a selected trading interval.

### 2.1.3 Relationship between Dispatched Generation and EMMS Data Model terms in Regional Energy Balance Equation

A Regional Energy Balance Equation describes the relationship between Dispatched Generation, Total Demand and Cleared Supply. The Regional Energy Balance Equation is used in the central dispatch process by the NEMDE to determine dispatch targets and regional prices.

The Regional Energy Balance Equation holds true for all intervals in Dispatch, Pre-dispatch and 5MPD if sufficient generation is dispatched to meet the demand. The equation using the EMMS terms (italicised) is given below.

$$DispatchableGeneration + Net\ Interconnector\ Targets\ (into\ the\ Region)$$

$$= TotalDemand + DispatchableLoad - WDR_{Dispatched} + Allocated\ Interconnector\ Losses$$

**where:**

Net Interconnector Targets

= Net *MWFlow* into the Region Over all Interconnectors connected to the region

Allocated Interconnector Losses

= Sum of (*MWLosses* x *FromRegionLossShare*<sup>A</sup>)

In the central dispatch process, the *TotalDemand* value is determined before the optimisation process and the values for the other variables are decided during the optimisation process. The right-hand-side (RHS) of the equation equates *ClearedSupply*, which is the forecast **scheduled demand** at the end of a trading interval. The left-hand side (LHS) of the equation shows the total generation dispatched, including interconnector imports, to meet that **scheduled demand**.

To obtain the data required for the equation provided earlier, refer to Appendix A3 for information on the relevant tables and field names in the EMMS Data model.

Example 4 in Appendix A4 illustrates the relationship between Supply (i.e. LHS of the equation) and Total Demand in the Regional Energy Balance Equation for a selected trading interval.

## 2.2 Demand Terms in EMMS Data Model used in PASA processes

The PASA processes comprise Pre-dispatch PASA (PDPASA), Short term PASA (STPASA) and Medium term PASA (MTPASA).

The EMMS Data Model terms used in PDPASA and STPASA are:

- *Demand10*: a 10% POE demand (a high demand forecast),
- *Demand50*: a 50% POE demand (an average demand forecast) and
- *Demand90*: a 90% POE demand (a low demand forecast).

Although *Demand90* is published for PDPASA and STPASA, it is no longer used by the PDPASA and STPASA processes<sup>32</sup>.

For MTPASA, AEMO publishes *Demand (POE 10)*, *Demand (POE 50)*, *NativeDemand (POE 10)* and *NativeDemand (POE 50)*.

The process for determining the POE demands used in PDPASA and STPASA is described in Section 2.2.1 and for MTPASA is described in Section 2.2.2.

### 2.2.1 Forecast PDPASA and STPASA demands

#### Process

The POE demands used in PDPASA and STPASA are derived from a forecast **operational demand**, determined by AEMO's Demand Forecasting System (DFS) and the Australian Wind Energy Forecasting System (AWEFS)/ Australian Solar Energy Forecasting System (ASEFS). These POE demands are determined by deducting the demand component met by significant non-scheduled wind/solar generation (obtained from AWEFS/ASEFS forecasts<sup>33</sup>) from the forecast **operational demand**.

The composition of the POE demands for the PDPASA and STPASA processes is shown in Figure 6.

---

<sup>32</sup> AEMO is required to publish a 90% POE demand for STPASA under the NER.

<sup>33</sup> AWEFS/ASEFS provide outputs of wind/solar farm generation forecasts for multiple timeframes (Short Term and Pre-dispatch). Each of these timeframes use different inputs and prediction models to provide forecast outputs.

**Figure 6 10%, 50%, and 90% POE demands in PDPASA and STPASA**

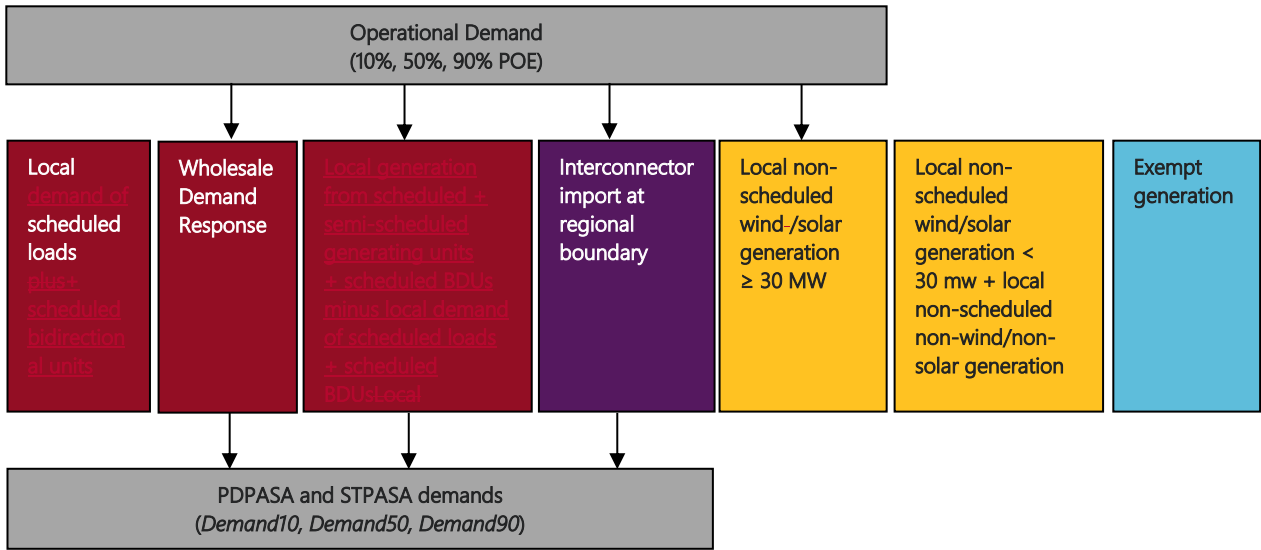

## 2.2.2 Forecast MTPASA Demands

### Process

MTPASA uses 10% and 50% POE **operational demand** forecasts for modelling. 10% and 50% POE **native demand** forecasts are also reported as part of the MTPASA process. The MTPASA process is detailed in the MTPASA Process Description<sup>34</sup>.

The composition of the POE demands used in the MTPASA process is shown in Figure 7 below.

**Figure 7 10% and 50% POE demands in MTPASA**

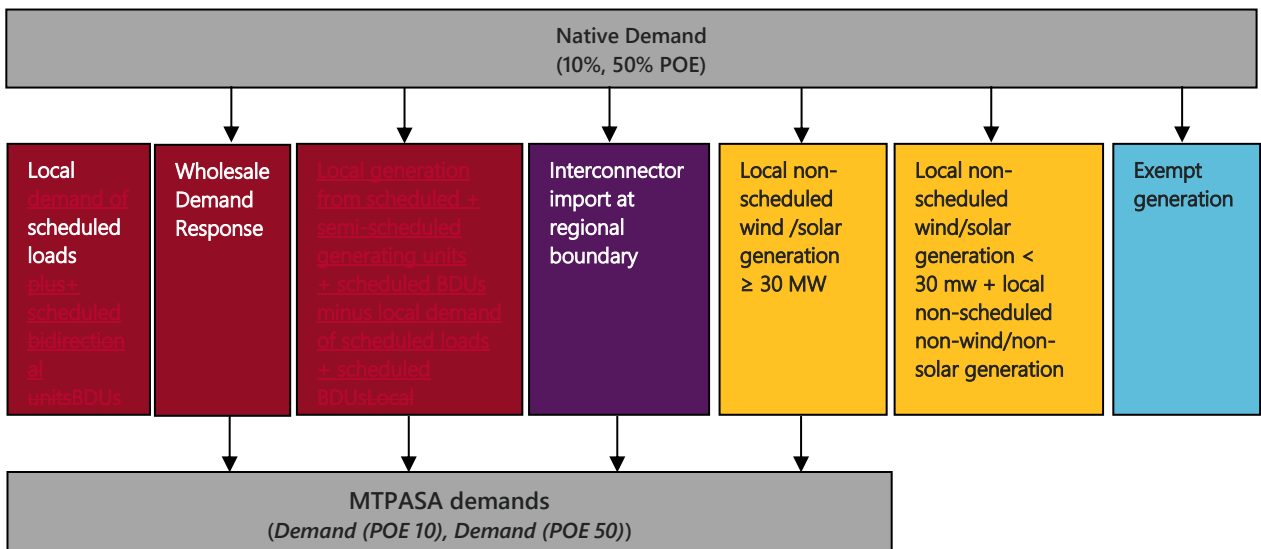

<sup>34</sup> MTPASA Process Description: <https://www.aemo.com.au/energy-systems/electricity/national-electricity-market-nem/nem-forecasting-and-planning/forecasting-and-reliability/projected-assessment-of-system-adequacy>



# A1. Probability of exceedance demands

The probability of exceedance (POE) demand is the probability or the likelihood the forecast would be met or exceeded. The three main types of POE demands are:

- 10% POE Demand.
- 50% POE Demand.
- 90% POE Demand.

They are used in the various processes within AEMO to determine a realistic range of power system and market outcomes.

## **50% POE demand**

A 50% probability of exceedance (POE) demand, also known as *Demand50*, implies there is a 50% probability of the forecast being met or exceeded.

## **10% POE demand**

The 10% probability of exceedance (POE) demand is the value that 10% of the actual demand values are expected to be above and 90% of the actual demand values are expected to be below.

## **90% POE demand**

The 90% probability of exceedance (POE) demand is the value that 90% of the actual demand values are expected to be above and 10% of the actual demand values are expected to be below.

# A2. Website publication information

The data listed in Table 2 is published to the EMMS Data Model via comma-delimited (csv) files. The comma-delimited files are published to the AEMO website at <https://www.aemo.com.au/energy-systems/electricity/national-electricity-market-nem/data-nem/market-management-system-mms-data>.

Table 5 below provides the file name for each EMMS Data model table.

**Table 5 List of files publishing EMMS Data model related to demand data**

Business Process	EMMS Data Model Package	EMMS Data Model Table	File Name
Dispatch	DISPATCH	DISPATCHREGIONSUM	PUBLIC_DISPATCHIS_<#CASE_DATETIME>*.ZIP
5MPD	P5MIN	P5MIN_REGIONSOLUTION	PUBLIC_P5MIN_<#CASE_DATETIME>*.ZIP
Pre-dispatch	PRE_DISPATCH	PREDISPATCHREGIONSUM	PUBLIC_PREDISPATCHIS_<#CASE_DATETIME>*.ZIP
PDPASA	PDPASA	PDPASA_REGIONSOLUTION	PUBLIC_PDPASA_<#CASE_DATETIME>*.ZIP
STPASA	STPASA_SOLUTION	STPASA_REGIONSOLUTION	PUBLIC_STPASA_<#CASE_DATETIME>*.ZIP
MTPASA	MTPASA	MTPASA_REGIONRESULT	PUBLIC_MTPASA_<#CASE_DATETIME>*.ZIP
	MTPASA	MTPASA_REGIONSUMMARY	PUBLIC_MTPASA_<#CASE_DATETIME>*.ZIP
Pre-dispatch PDPASA STPASA	DEMAND_FORECASTS	DEMANDOPERATIONALACTUAL	PUBLIC_ACTUAL_OPERATIONAL_DEMAND_HH_<#CASE_DATETIME>*.ZIP
	DEMAND_FORECASTS	DEMANDOPERATIONALFORECAST	PUBLIC_FORECAST_OPERATIONAL_DEMAND_HH_<#CASE_DATE TIME>*.ZIP

Operational demand (Actual and Forecast) was published as part of the November 2014 EMMS data model release<sup>35</sup>. The operational demand data fields are outlined in Table 6 below:

**Table 6 Operational Demand data fields**

EMMS Data Model Table	Field Name	Description
DEMANDOPERATIONALACTUAL	OPERATIONAL_DEMAND	Average 30-minute measured operational demand MW value (unadjusted and not reconstituted with estimated actual WDR).
	OPERATIONAL_DEMAND_ADJUSTMENT	Adjustment value containing the estimated amount of activated RERT and involuntary load shedding that occurred as a result of a NER 4.8.9 instruction for load shedding from AEMO.
	WDR_ESTIMATE	Estimated average 30-minute MW amount of Wholesale Demand Response that occurred.
DEMANDOPERATIONALFORECAST	OPERATIONAL_DEMAND_POE10	10% probability of exceedance operational demand forecast value
	OPERATIONAL_DEMAND_POE50	50% probability of exceedance operational demand forecast value
	OPERATIONAL_DEMAND_POE90	90% probability of exceedance operational demand forecast value

<sup>35</sup> The published Operational Demand (Actual and Forecast) csv files can be found at <https://www.aemo.com.au/energy-systems/electricity/national-electricity-market-nem/data-nem/operational-demand-data>.

# A3. EMMS table field names for obtaining data for computing EMMS terms

Only the fields that are not covered in Table 2 and introduced as inputs to the equations in Section 2.1 are covered in below. Table 7 provides the MMS Data Model table and field names.

**Table 7 EMMS Data Model**

Description	Table in EMMS Data Model	EMMS Field Name
Actual generation of Scheduled and Semi-scheduled generating units <u>and Scheduled BDUs</u> and WDR	For Dispatch: DISPATCHLOAD For Pre-dispatch: PREDISPATCHLOAD For 5MPD: P5MIN_UNITSOLUTION	INITIALMW
Actual interconnector flow at regional boundary	For Dispatch: DISPATCHINTERCONNECTORRES For Pre-dispatch: PREDISPATCHINTERCONNECTORRES For 5MPD: P5MIN_INTERCONNECTORSOLN	METEREDMWFLOW
Targets for Scheduled and Semi-scheduled generating units <u>and Scheduled BDUs</u> and WDR	For Dispatch: DISPATCHLOAD For Pre-dispatch: PREDISPATCHLOAD For 5MPD: P5MIN_UNITSOLUTION	TOTALCLEARED
Target for Interconnector flow at regional boundary	For Dispatch: DISPATCHINTERCONNECTORRES For Pre-dispatch: PREDISPATCHINTERCONNECTORRES For 5MPD: P5MIN_INTERCONNECTORSOLN	MWFLOW
Interconnector MW Losses	For Dispatch: DISPATCHINTERCONNECTORRES For 5MPD: P5MIN_INTERCONNECTORSOLN For Pre-dispatch: PREDISPATCHINTERCONNECTORRES	MWLOSSES
From Region Loss Share	INTERCONNECTORCONSTRAINT	FROMREGIONLOSSSHARE
Demand Forecast, ADE	For Dispatch: DISPATCHREGIONSUM For 5MPD: P5MIN_REGIONSOLUTION	DEMANDFORECAST, AGGREGATEDISPATCHERROR
Region Dispatched Generation (Sum of dispatched <u>generation from</u> Scheduled and Semi-scheduled generation <u>and Scheduled BDUs</u> )	DISPATCHREGIONSUM	DISPATCHABLEGENERATION
Region Dispatched Loads (Sum of dispatched <u>demand of</u> Scheduled loads <u>and Scheduled BDUs</u> )	DISPATCHREGIONSUM	DISPATCHABLELOAD
Region Actual <sup>28</sup> Wholesale Demand Response (Sum of WDR units)	For Dispatch: DISPATCHREGIONSUM For Pre-dispatch: PREDISPATCHREGIONSUM For 5MPD: P5MIN_REGIONSOLUTION	WDR_INITIALMW

Description	Table in EMMS Data Model	EMMS Field Name
Region Dispatched Wholesale Demand Response (Sum of WDR units)	For Dispatch: DISPATCHREGIONSUM For Pre-dispatch: PREDISPATCHREGIONSUM For 5MPD: P5MIN_REGIONSOLUTION	WDR_DISPATCHED

# A4. Examples

The EMMS terms and formulae introduced in Section 2.1 are explained using a selected trading interval below. The selected interval is the trading interval ending 0310 hrs on 11 July 2010 and the selected region is NSW. This particular trading interval and region were selected because the amount of the scheduled load dispatched in NSW was non-zero for the interval.

The relevant EMMS data for the selected trading interval is provided in Table 8.

**Table 8 EMMS Data for Trading Interval ending 0310 hrs on 11 July 2010**

EMMS Field Names	EMMS recorded values	EMMS Field Names	EMMS recorded values
<i>MeteredMWFlow (QNI)</i>	-1002.84	<i>InitialMW (Generation)</i>	5339.73
<i>MeteredMWFlow (Terranora)</i>	-136.19	<i>TotalCleared (Loads)</i>	195
<i>MeteredMWFlow (VIC-NSW)</i>	612.64	<i>TotalCleared (Generation)</i>	5309.32
<i>MWLosses (QNI)</i>	57.95	<i>TotalDemand</i>	6801.76
<i>MWLosses (Terranora)</i>	3.5	<i>DemandForecast</i>	-22.51
<i>MWLosses (VIC-NSW)</i>	28.12	<i>DispatchableGeneration</i>	5309.32
<i>MWFlow (QNI)</i>	-983.61	<i>NetInterchange</i>	-1687.44
<i>MWFlow (Terranora)</i>	-137	<i>ClearedSupply</i>	7041.37
<i>MWFlow (VIC-NSW)</i>	611.44	<i>InitialSupply</i>	7091.41
<i>InitialMW (Loads)</i>	221.26	<i>AggregateDispatchError (ADE)</i>	0
<i>WDR_InitialMW</i>	0	<i>WDR_Dispatched</i>	0

Examples 1, 2, and 3 below demonstrate how *InitialSupply*, *ClearedSupply*, and *TotalDemand* can be achieved using the formulae provided in Section 2.1. The manually calculated values using the formulae are then compared against the system calculated values, which are published to the EMMS Data Model. Example 4 demonstrates that the regional energy balance equation holds true for the selected trading interval.

## Example 1

The table below provides the published EMMS data (refer to Table 8) and manually calculated values for *Initial Supply* using the formula in Section 2.1.

Date	Published EMMS Data				Manually Calculated Data		
	<i>Initial Supply</i>	<i>Metered MW Flow (QNI)</i>	<i>Metered MW Flow (Terranora)</i>	<i>Metered MW Flow (VIC-NSW)</i>	<i>Net Initial MW (EMMS data summated)</i>	<i>Net Import to NSW (EMMS data summated)</i>	<i>Initial Supply (from the formula)</i>
11/07/2010 03:10	7091.41	-1002.84 <sup>A</sup>	-136.19	612.64	5339.73	1751.67 <sup>B</sup>	7091.40

A. A flow of -1002.84 MW on NSW1-QLD1 means an import of +1002.84 MW into NSW on that interconnector. The +ve or -ve sign represents the direction of flow on the interconnector with northerly flow being +ve and southerly flow being -ve.

B. Net Import into NSW = +1002.84 (NSW1-QLD1) + 136.19 (N-Q-MNSP1) + 612.64 (VIC1-NSW1) = 1751.67 MW.

The Net *InitialMW* value was determined by summing the individual ~~generation generating unit~~ *InitialMW* (SCADA) values for all scheduled and semi-scheduled generators and scheduled BDUs in NSW. Net Import into NSW was calculated by extracting the *MeteredMWFlow* (SCADA) values for QNI (NSW1-QLD1), Terranora (N-Q-MNSP1) and Victoria to NSW (VIC1-NSW1) Interconnectors and subtracting the exports out of the region from imports into the region. A minor discrepancy between the dispatch value and calculated value exists possibly due to rounding errors.

### Example 2: Cleared Supply in Dispatch

The table below provides the published EMMS data (refer to Table 8) and manually calculated values for *Cleared Supply* using the formula in Section 2.1.

Date	Published EMMS Data					Manually Calculated Data	
	<i>Cleared Supply</i>	<i>Net Total Cleared (Total Dispatch targets)</i>	<i>MW Flow (NSW-QLD)</i>	<i>MW Flow (Terranora)</i>	<i>MW Flow (VIC-NSW)</i>	<i>Net Import Target into NSW (EMMS data summated)</i>	<i>Cleared Supply (from the formula)</i>
11/07/2010 03:10	7041.37	5309.32	-983.61 <sup>A</sup>	-137.00	611.44	1732.05 <sup>B</sup>	7041.37

A. A flow of -983.61 MW on NSW1-QLD1 is the same as an import of +983.61 MW into NSW on that interconnector.

B. Net Import into NSW = +983.61 (NSW1-QLD1) + 137 (N-Q-MNSP1) + 611.44 (VIC1-NSW1) = 1732.05 MW.

The Net *TotalCleared* value is the same as the published *DispatchableGeneration* value in the EMMS Data Model. This value can also be determined by summing the individual ~~generation generating unit~~ dispatch targets (i.e. *TotalCleared*) for all scheduled and semi-scheduled generators and scheduled BDUs in NSW. Net Import Target into NSW is calculated by extracting the *MWFlow* values for QNI (NSW1-QLD1), Terranora (N-Q-MNSP1) and Victoria to NSW (VIC1-NSW1) Interconnectors and subtracting the exports out of the region from imports into the region.

### Example 3: Total Demand in Dispatch

The table below provides the published EMMS data (refer to Table 8) and manually calculated values for *Total Demand* using the formula in Section 2.1.

Date	Published EMMS Data				Manually Calculated Data				
	<i>Total Demand</i>	<i>WDR_InitialMW</i>	<i>Demand Forecast</i>	<i>ADE</i>	<i>Net Load Initial MW (EMMS data summated)</i>	<i>Net Generation Initial MW (EMMS data summated)</i>	<i>Net Allocation Interconnector Losses (EMMS data calculated)</i>	<i>Net Import into NSW (EMMS data)</i>	<i>Total Demand (from the formula)</i>
11/07/2010 03:10	6801.76	0	-22.51	0	221.26	5339.73	44.61 <sup>A</sup>	1750	6801.35

A. Net Interconnector Loss allocated to NSW

= 3.5 (MW Loss on N-Q-MNSP) \* 0.65 (Loss Factor Allocation to NSW on N-Q-MNSP) +  
57.95 (MW Loss on NSW-QLD) \* 0.42 (Loss Factor Allocation to NSW on NSW-QLD)+  
28.12 (MW Loss on VIC-NSW) \* 0.64 (Loss Factor Allocation to NSW on VIC-NSW).

The Net Generation *InitialMW* value is determined by summing the individual ~~generating unit~~ *generation InitialMW* values for all scheduled and semi-scheduled generators and scheduled BDUs in the NSW region. The Net Load *InitialMW* value is determined by summing the individual ~~demand scheduled load~~ *InitialMW*

values of for all scheduled loads and scheduled BDUs. The interconnector flow values (*MeteredMWFlow*) are extracted for QNI (NSW1-QLD1), Terranora (N-Q-MNSP1) and Victoria to NSW (VIC1-NSW1) Interconnectors and net import calculated by subtracting the exports out of the region from imports into the region.

The discrepancy between the manually calculated *Total Demand* value and the dispatch value (determined by NEMDE) is due to a subtlety involving the interconnector loss calculated. The *TotalCleared* interconnector losses (from which the Allocated Interconnector Losses are determined) are calculated from interconnector target flow instead of *InitialMW* flow. The latter of these values is not reported by NEMDE. As NEMDE actually uses the estimated losses at the beginning of the trading interval to determine *Total Demand*, the manual calculation is only an approximation of the NEMDE calculation<sup>7</sup> and is a source of some of the result discrepancy.

#### Example 4: Regional Energy Balance Equation in Dispatch

The Regional Energy Balance Equation is provided below. The RHS of the equation equates *ClearedSupply*.

*DispatchableGeneration* + Net Interconnector Targets (into the Region)

= *TotalDemand* + *DispatchableLoad* - *WDR\_Dispatched* + Allocated Interconnector Losses

The Regional Energy Balance in the NSW region for the selected trading interval is shown below.

Dispatchable Generation	5309.32	=	Total Demand	6801.35
Target Interconnector Flow	1732.05		Dispatchable Load	195
<b>Balance on LHS</b>	7041.37		Wholesale Demand Response	0
			Interconnector losses	44.61
			<b>Balance on RHS</b>	7041.37

*DispatchableGeneration*, *TotalDemand*, *MWFlow*, *DispatchableLoad*, *WDR\_Dispatched* and *MWLosses* values are extracted from the respective region tables in the EMMS Data Model.

# Glossary

Term	Definition
5MPD	Five-minute Pre-dispatch
ADE	Aggregate Dispatch Error
ASEFS	Australian Solar Energy Forecasting System
AWEFS	Australian Wind Energy Forecasting System
<a href="#">BDU</a>	<a href="#">Bi-Directional Unit</a>
EMMS	Electricity Market Management System
ESOO	Electricity Statement of Opportunities
JPB	Jurisdictional Planning Body
LHS	Left-hand side
MNSP	Market Network Service Provider
MTPASA	Medium Term Projected Assessment of System Adequacy
MW	Megawatt
NEFR	National Electricity Forecasting Report
NEM	National Electricity Market
NEMDE	National Electricity Market Dispatch Engine
NER	National Electricity Rules
PDPASA	Pre-dispatch Projected Assessment of System Adequacy
POE	Probability of Exceedance
QNI	Queensland to New South Wales Interconnector
RHS	Right-hand side
RRN	Regional Reference Node
SCADA	Supervisory Control and Data Acquisition
STPASA	Short Term Projected Assessment of System Adequacy
WDR	Wholesale Demand Response