

# DECLARED WHOLESALE GAS MARKET PARTICIPANT BUILD PACK

PREPARED BY: AEMO Gas Markets and System Operations  
VERSION: 5.0  
EFFECTIVE DATE: 24 August 2022  
STATUS: FINAL

Approved for distribution and use by:

APPROVED BY: Matthew Clemow  
TITLE: Group Manager Gas Markets and System Operations

DATE: 10 / 08 / 2022

## Disclaimer

This document is made available to you on the following basis:

### Purpose

This DWGM Participant Build Pack (“Pack”) has been produced by the Australian Energy Market Operator Limited (AEMO) to provide information about DWGM as at the date of publication.

### No substitute

This Guide is not a substitute for, and should not be read in lieu of, the current National Electricity or Gas Rules (“Rules”), National Electricity or Gas Law (“Law”), or any other relevant laws, codes, rules, procedures or policies. Further, the contents of this Pack do not constitute legal or business advice and should not be relied on as a substitute for obtaining detailed advice about the Law, the Rules, or any other relevant laws, codes, rules, procedures or policies, or any aspect of the national electricity market or the electricity industry.

### No warranty

While AEMO has used due care and skill in the production of this Pack, neither AEMO, nor any of its employees, agents and consultants make any representation or warranty as to the accuracy, reliability, completeness or suitability for particular purposes of the information in this Pack.

### Limitation of liability

To the extent permitted by law, AEMO and its advisers, consultants and other contributors to this Pack (or their respective associated companies, businesses, partners, directors, officers or employees) shall not be liable for any errors, omissions, defects or misrepresentations in the information contained in this Pack, or for any loss or damage suffered by persons who use or rely on such information (including by reason of negligence, negligent misstatement or otherwise). If any law prohibits the exclusion of such liability, AEMO’s liability is limited, at AEMO’s option, to the re-supply of the information, provided that this limitation is permitted by law and is fair and reasonable.

<b>Copyright</b>	Copyright © 2022 Australian Energy Market Operator Limited. All rights reserved.	
<b>Trademark Notices</b>	Microsoft Excel (Excel) is a trademark of Microsoft Corporation in the United States and/or other countries.	
<b>Distribution</b>	Available to the public.	
<b>Prepared by</b>	Gas IT Support	
<b>Last update</b>	10 August 2022	<b>Notes</b> See change notes
<b>Documents made obsolete</b>	The release of this document changes only the version of DWGM Participant Build Pack.	

## Further Information

For further information, please visit AEMO’s website [www.aemo.com.au](http://www.aemo.com.au) or contact:

AEMO Information and Support Hub      Phone: 1300 AEMO 00 (1300 236 600) and follow the prompts.  
 E-mail: [supporthub@aemo.com.au](mailto:supporthub@aemo.com.au)

## Documentation Revision History

Version	Date	Comments
0.1	13/06/2005	Initial draft
0.2	28/07/2005	<ul style="list-style-type: none"> <li>AS comments incorporated.</li> <li>“Uplift hedge nomination” term is replaced with “injection hedge nomination”.</li> <li>Removed references to BOD and scheduling intervals absolute time references.</li> <li>Added MIBB reports references</li> </ul>
0.3	22/08/2005	Incorporated comments resulting from an internal review
1.0	26/09/2005	<ul style="list-style-type: none"> <li>Appended commas at the end of the literals example</li> <li>Added comment regarding redundancy of the market_participant field in the upload file header</li> <li>Corrected description for AgencyNomActivityDescriptor</li> <li>Clarified the use of web services automation in the scope of this document</li> <li>Cleaned up the overview section language</li> <li>Added clarification of treatment of leading and trailing spaces, tab characters, and special characters (to synchronise with Retail systems PBP).</li> <li>Updated description of SchedIntervalDescriptor</li> <li>Added footnote to clarify the use of M/O/NR attribute for demand forecast fields</li> <li>Mirr field for injection hedge nomination interface set to “not required” (NR)</li> </ul>
1.1	17/10/2005	<ul style="list-style-type: none"> <li>Deleted dd/mm/ccyy date format to make it consistent with MIBB reports</li> <li>Corrected description of SchedIntervalDescriptor for value 3</li> <li>Clarified the use of commencement_date field</li> <li>Added footnote reference to non site-specific demand forecast fields.</li> </ul>
1.2	18/11/2005	<ul style="list-style-type: none"> <li>Updated section 2.5.1, Table 7 as per Origin’s comment. Added Pakenham (Bass Gas) Injection point.</li> <li>Added description of ParticipantDescriptor in Table 1 to reflect the use of participant identifiers as defined in VENCORP organisation register. CSV examples updated.</li> </ul>
1.3	15/03/2006	<ul style="list-style-type: none"> <li>Added minimum daily quantity field for withdrawal bids (updated fields format and CSV sample)</li> <li>Corrected the number of injection sites in the Injection hedge Nomination interface: 5</li> <li>Added web services automation specifications for bids and demand forecast (injection hedge and agency injection hedge nominations functionality will follow)</li> </ul>
1.4	21/06/2006	<ul style="list-style-type: none"> <li>Minor description changes to reflect the addition of web services.</li> <li>Updated agency injection nomination lifecycle diagram</li> <li>Added web services descriptions for Injection Hedge Nomination and Agency Injection Hedge Nomination functions</li> </ul>
1.5	15/08/2006	<ul style="list-style-type: none"> <li>Updated bids and demand forecast specifications to reflect additional types in the aseXML schema</li> </ul>

Version	Date	Comments
		<ul style="list-style-type: none"> <li>All aseXML schema fragments and request/responses samples updated to match schema r20. Note, this affected the order of elements in the schema – the schema mandatory elements are first, followed by optional elements.</li> <li>Added notes to many of the web services operations to clarify the business usage/validation of elements.</li> <li>Added SystemService operation to retrieve scheduling interval information.</li> <li>Corrected definitions in the CSV Bidding Interface (Section 2.3) – bid quantities in adjacent steps can be equal, whereas prices can not.</li> <li>Corrected SOAP fault descriptions</li> <li>Clarified definition of the termination date: it is non-inclusive, and must be at least one day ahead of the commencement date</li> </ul>
1.6	12/09/2006	<ul style="list-style-type: none"> <li>Updated web services diagnostics by correcting descriptions of existing and adding more specific SOAP faults.</li> </ul>
1.7	24/10/2006	<ul style="list-style-type: none"> <li>Updated web services diagnostics by adding following SOAP faults: 3112, 3113, 3714, 3803</li> <li>Corrected Section 2.5 Injection Hedge Nomination Interface to list the injection sites as they appear on the WebExchanger browser interface.</li> <li>Corrected CSV file format samples for Injection Hedge Nomination, Section 2.5 – inserted missing value/comma</li> </ul>
1.8	17/01/2007	<ul style="list-style-type: none"> <li>Updated XML samples to include <i>xmlns:xsi</i> definition where it was missing</li> </ul>
1.9	03/10/2007	<ul style="list-style-type: none"> <li>Updated sections containing Minimum Daily Quantity which can now only be zero</li> <li>Updated the Injection Hedge Nomination File Format Changes</li> <li>Minor correction related to the Time zone. aseXML examples were showing +11 and this has been modified to +10 to reflect AEST.</li> </ul>
2.0	21/02/2012	<ul style="list-style-type: none"> <li>Updated IHN and AIHN sections</li> <li>Added AMDQ Nomination section</li> <li>Updated Bidding Interface section with reduced Bid quantities changes in reschedules</li> <li>Updated doc reference for MIBB Reports Document</li> <li>Replaced references to VENCORP with AEMO</li> <li>Added IHN related webservice fault codes</li> <li>As agreed with GWCF the GMP Participant Build Pack is renamed to Declared Wholesale Gas Market Participant Build Pack</li> <li>Cleaned up WEX error codes and page reference numbers.</li> <li>Modified CPP name “BassGas” to match production “Bass Gas” with a space <b>“highlighted in blue”</b></li> </ul>
3.0	21/06/2012	<p>Updated with Gas Build 31 changes:</p> <ul style="list-style-type: none"> <li>Added new global fault codes to 5.3.1</li> <li>Added new fault codes to IHN Web Service (Section 5.6.5.3)</li> <li>Updated relevant code examples and diagrams in Sections 5.6 and 5.7 to reflect tag name changes</li> </ul>

Version	Date	Comments
		<ul style="list-style-type: none"> <li>Added new section for AMDQ nomination Web Service (Section 5.8)</li> <li>Added new Appendix for AMDQ nomination Web Service WSDL file</li> <li>Updated all relevant references from r20 to r30 in Web Services sections</li> <li>Added 'Note 3' to Section 5.8.5.1</li> <li>Modified wording of error code 3803</li> <li>Updated field type for AMDQ Nomination field in Section 2.7.1</li> <li>Updated Note 1 in Section 5.7.5</li> <li>Removed Global error code 3104. Error code 3002 will always be called before 3104 hence no need for 3104</li> <li>Updated wording for error code 3901</li> </ul>
4.0	17/12/2012	<p>Updated with Gas Release 32 changes for QC#9811:</p> <ul style="list-style-type: none"> <li>Updated IHN CSV interface spec (section 2.5.1)</li> <li>Updated IHN Web Services aseXML schema diagrams and sample xml (section 5.6)</li> <li>Updated aseXML version from r30 to r31 in the relevant Web Services sections</li> <li>Added a new note (Note 5) to Section 5.6.5.1</li> <li>Updated WSDL files in Appendices</li> </ul> <p>Added disclaimer page to the document.</p>
4.1	29/10/2020	Updated to incorporate Allocation Agent data submission through MIBB CSV file upload as per section 3.4.
5.0	10/08/2022	Updated to define the Markets Portal web interfaces new "DWGM" section for Capacity Certificate auctions and Capacity Certificate transfers.

## Table of Contents

<b>1</b>	<b>Introduction .....</b>	<b>9</b>
1.1	<b>Purpose .....</b>	<b>9</b>
1.2	<b>Audience.....</b>	<b>9</b>
1.3	<b>Scope .....</b>	<b>9</b>
1.4	<b>Related Documents .....</b>	<b>9</b>
	<b>Definitions, Acronyms and Abbreviations.....</b>	<b>10</b>
1.5	<b>Overview and Structure .....</b>	<b>10</b>
<b>2</b>	<b>WebExchanger Interface.....</b>	<b>12</b>
2.1	<b>Overview .....</b>	<b>12</b>
2.2	<b>General Requirements .....</b>	<b>15</b>
2.2.1	File format .....	15
2.2.2	Line delimiters .....	15
2.2.3	Field delimiters .....	16
2.2.4	Optional fields.....	16
2.2.5	Treatment of literals.....	16
2.2.6	Leading and trailing spaces.....	16
2.2.7	Tab characters .....	16
2.2.8	Special characters.....	16
2.2.9	Positive and negative numeric values.....	17
2.2.10	Leading and trailing zeroes .....	17
2.2.11	Data dictionary .....	17
2.2.12	File naming convention .....	20
2.2.13	File header .....	20
2.3	<b>Bidding Interface .....</b>	<b>22</b>
2.3.1	Injection Bid Interface Definition.....	23
2.3.2	Withdrawal Bid Interface Definition .....	25
2.3.3	Examples.....	26
2.4	<b>Demand Forecast Interface.....</b>	<b>27</b>
2.4.1	Site Specific Demand Forecast .....	27
2.4.2	Non-Site Specific Demand Forecast .....	30
2.4.3	Examples.....	32
2.5	<b>Injection Hedge Nomination Interface .....</b>	<b>32</b>
2.5.1	File format .....	33
2.5.2	Examples.....	34
2.6	<b>Agency Injection Hedge Nomination Interface .....</b>	<b>34</b>
2.6.1	File format .....	37
2.6.2	Examples.....	41
2.6.3	Notification email format.....	42
2.6.4	Examples.....	44
2.7	<b>AMDQ Nomination Interface .....</b>	<b>44</b>
2.7.1	File format .....	44
2.7.2	Examples.....	45
<b>3</b>	<b>Markets Portal web interface.....</b>	<b>47</b>
3.1	<b>Overview .....</b>	<b>47</b>
3.2	<b>User rights access .....</b>	<b>47</b>

3.3	<b>DWGM Capacity Certificate auction process</b> .....	47
3.4	<b>Accessing DWGM Capacity Certificate Functionality</b> .....	47
3.5	<b>CC auction and bidding process</b> .....	48
3.5.1	CC auction: pre-auction process .....	48
3.5.2	CC auction: bidding process .....	48
3.5.3	CC auction: post-auction process .....	49
3.6	<b>CC auction: transfer process</b> .....	49
3.7	<b>CSV file data requirements</b> .....	49
3.7.1	Operation of the Download CSV .....	49
3.7.2	Operation of the Upload CSV .....	49
4	<b>MIBB Reports</b> .....	51
4.1	<b>Overview</b> .....	51
4.2	<b>CSV Reports</b> .....	51
4.2.1	File naming .....	51
4.2.2	Report structure .....	51
4.2.3	Report header .....	51
4.2.4	Report body .....	52
4.3	<b>HTML Report Template</b> .....	52
4.3.1	Common header .....	52
4.3.2	Report body .....	52
4.3.3	Common footer .....	53
4.4	<b>CSV File Upload</b> .....	53
4.4.1	Allocation Agent Supplied File Format Requirements .....	53
5	<b>WebExchanger Web Services Automation</b> .....	55
5.1	<b>Overview</b> .....	55
5.2	<b>General Requirements</b> .....	56
5.2.1	Web Services, XML and SOAP .....	56
5.2.2	WebExchanger Web Services on Java Enterprise Edition (JEE) .....	57
5.2.3	WebExchanger Web Services on .NET .....	57
5.2.4	Web Services Model .....	57
5.2.5	Web Services Security and Authentication .....	58
5.2.6	WebExchanger Error Handling and SOAP Faults .....	59
5.2.7	aseXML .....	60
5.2.8	WSDL .....	60
5.2.9	WS-I .....	60
5.3	<b>Fault Codes</b> .....	61
5.3.1	Global Fault Codes .....	61
5.3.2	Web Service Specific Fault Codes .....	62
5.4	<b>Web Service: Bid Service</b> .....	63
5.4.1	GetBid .....	63
5.4.2	GetBidSet .....	69
5.4.3	GetBidSetForCGD .....	77
5.4.4	SearchBids .....	82
5.4.5	SubmitBid .....	88
5.5	<b>Web Service: Demand Forecast Service</b> .....	95
5.5.1	Introduction .....	95
5.5.2	GetForecast .....	95
5.5.3	GetForecastForCGD .....	101
5.5.4	GetValidationValues .....	105

5.5.5	SetValidationValues .....	110
5.5.6	SearchForecasts .....	115
5.5.7	SubmitForecast .....	121
<b>5.6</b>	<b>Web Service: Injection Hedge Nomination Service .....</b>	<b>127</b>
5.6.1	Introduction.....	127
5.6.2	GetInjectionHedgeNomination .....	127
5.6.3	GetInjectionHedgeNominationForCGD .....	134
5.6.4	SearchInjectionHedgeNominations .....	140
5.6.5	SubmitInjectionHedgeNomination .....	146
<b>5.7</b>	<b>Web Service: Agency Injection Hedge Nomination Service .....</b>	<b>154</b>
5.7.1	Introduction.....	154
5.7.2	GetAgencyNominationHeader.....	156
5.7.3	GetAgencyNominationDetail .....	160
5.7.4	SearchNominations .....	164
5.7.5	SubmitNomination .....	171
5.7.6	SubmitNominationWithdrawn .....	177
5.7.7	SubmitConfirmation .....	182
5.7.8	SearchConfirmations .....	187
5.7.9	SubmitWithdrawnNominationConfirmed .....	191
5.7.10	GetAgencyConfirmationHeader .....	196
<b>5.8</b>	<b>Web Service: AMDQ Nomination Service.....</b>	<b>202</b>
5.8.1	Introduction.....	202
5.8.2	GetAMDQNomination.....	202
5.8.3	GetAMDQNominationForCGD .....	207
5.8.4	SearchAMDQNominations .....	211
5.8.5	SubmitAMDQNomination .....	215
<b>5.9</b>	<b>Web Service: System Service.....</b>	<b>221</b>
5.9.1	Introduction.....	221
5.9.2	GetCurrentGasDate .....	221
5.9.3	GetIntervallInfo.....	223
<b>6</b>	<b>Appendix A. Bids Service WSDL .....</b>	<b>228</b>
<b>7</b>	<b>Appendix B. Participants Demand Forecast Service WSDL.....</b>	<b>233</b>
<b>8</b>	<b>Appendix C. Injection Hedge Nomination Service WSDL.....</b>	<b>239</b>
<b>9</b>	<b>Appendix D. Agency Hedge Nomination Service WSDL.....</b>	<b>244</b>
<b>10</b>	<b>Appendix D. AMDQ Nomination Service WSDL.....</b>	<b>253</b>
<b>11</b>	<b>Appendix E. System Service WSDL.....</b>	<b>258</b>

## Table of Figures

Figure 1	File upload overview sequence diagram for a bid .....	14
Figure 2	AEMO provided CSV interfaces .....	15
Figure 3	Bidding terminology .....	22
Figure 4	Agency injection hedge nomination sequence diagram .....	35
Figure 5	Agency injection hedge nomination withdrawal .....	36
Figure 6	Agency injection nomination lifecycle .....	37
Figure 7	Markets Portal > DWGM > submenus .....	48

## Table of Tables

Table 1	Field types.....	17
---------	------------------	----



Table 2 Upload file header .....	20
Table 3 Injection bid fields .....	24
Table 4 Withdrawal bid fields .....	25
Table 5 Site specific demand forecast fields.....	28
Table 6 Non-site specific demand forecast fields .....	30
Table 7 Injection hedge nomination fields.....	33
Table 8 Agency injection hedge nomination fields.....	38
Table 9 Agency nomination notifications email format.....	42
Table 10 AMDQ Nomination Fields .....	45
Table 11. Apportionment types .....	171
Table 12. Nomination status .....	171

# 1 Introduction

## 1.1 Purpose

The purpose of this document is to specify the data formats and the rules of information exchange between AEMO and Gas Market Participants in the context of the Victorian Wholesale Gas Market.

## 1.2 Audience

The primary audience for this document are business users and IT developers of the Market Participants, and AEMO business users and IT developers involved in the design and implementation of gas market systems for the wholesale market.

This document assumes the audience has a basic understanding of Unified Modelling Language (UML) and understands UML concepts and syntax.

## 1.3 Scope

This document details the upload file formats required by WebExchanger within the scope of the Victorian Wholesale Gas Market.

This document details the web services technology for automating the submission of bids, demand forecast and injection nominations and the implementation of the web services based automation for WebExchanger. Also included in this document details of the changes to the aseXML related to the implementation of the WebExchanger automation.

The User Guide to MIBB Reports specifies the generic structure of these reports.

## 1.4 Related Documents

Document Name	Location
User Guide to MIBB Reports	MIBB > Public > Directory Listing > Documents
WebExchanger User Guide	MIBB > Public > Directory Listing > Documents

## Definitions, Acronyms and Abbreviations

Term	Description
AEST	Australian Eastern Standard Time
ASCII	American Standard Code for Information Interchange. A standard coding scheme that assigns numeric values to letters, numbers, punctuation marks, and control characters, to achieve compatibility among different computers and peripherals
aseXML	A Standard for Energy Transactions in XML
CSV	Comma-Separated Values, a comma delimited text
GJ	1000 Mega Joules, 10 <sup>9</sup> Joules, Joule is a unit of energy
GMP	Gas Market Project
M	Mandatory, in the context of this document, indicates that the field's value must be provided
MIBB	Market Information Bulletin Board
MIRN	Metering Installation Registration Number
NMI	National Meter Identifier. Also known as a MIRN.
NR	Not required, in the context of this document, indicates that the value will be ignored by the parsing application even if it is provided
O	Optional, in the context of this document, indicates that the field's value needs not to be provided, but will be processed if it was
UML	Unified Modelling Language
WEX	WebExchanger is a AEMO application designed to collect information from market participants that is required for gas scheduling
CPP	Close Proximity Point (CPP) has the same meaning as the term Close Proximity Injection Point used in the National Gas Rules.

## 1.5 Overview and Structure

This document comprises the following sections:

- Introduction – outlines the purpose of this Participant Build Pack, the intended audience, and scope.
- Interfaces – contains general requirements and external interface specifications for the Victorian Wholesale Gas Market with respect to CSV files upload and notification email formats.
- MIBB Reports – general requirements and high-level specifications for MIBB reports.
- WebExchanger web services automation.

- Appendices that detail Web Services definitions for bid, demand forecast, injection hedge nomination, and agency hedge nomination services.

## 2 WebExchanger Interface

### 2.1 Overview

Market Participants are required under the new National Gas Rule (NGR) to provide information that is used as input to AEMO gas scheduling process via WebExchanger. Architecturally, WebExchanger is a multi-tier application that will provide Market Participants with a web browser interface for manual submission of:

- bids,
- demand forecasts,
- injection hedge nominations,
- agency injection hedge nominations, and
- AMDQ nominations.

Apart from manual entry in WebExchanger of bids, demand forecasts, injection hedge nominations, agency injection hedge nominations, and AMDQ nominations, the Market Participants will also have the ability to provide the same information by uploading a comma-separated values (CSV) file prepared using third-party tools. This provides a simple semi-automated facility for submissions that is time-proven and familiar to all Market Participants.

In general, the process is common to all file upload interfaces and includes the following steps:

- A Market Participant prepares a data file utilising any available third-party tools, for example Microsoft® Excel<sup>1</sup>, or any text editor.
- Each file can only contain only one of the following options:
  - A single bid, or
  - A single non-site specific demand forecast or a single site specific demand forecast, or
  - A single injection hedge nomination, or
  - A single agency injection hedge nomination that may contain up to 10 participants.
- The Market Participant selects the upload file function from the appropriate screen in WEX, which results in a “file open” dialogue presented to the participant.
- After the required file is located and selected, WEX will upload the file and make sure that the format of the data stored in the file, as defined in this document, is acceptable. Note, at this point, there will be no validation whether the uploaded data makes any sense from the AEMO’s scheduling perspective. The format errors will be returned to the participant via an error dialogue. The Market Participant can rectify the error and attempt to upload the file again.

---

<sup>1</sup> When a text file with .CSV extension is opened in Microsoft Excel, Excel changes the date format to dd-MM-YY, that would make it incompatible with the date format specification as defined in this document, i.e. dd MMM YYYY.

- If WEX finds the uploaded data format acceptable, it will produce an appropriate screen with uploaded data populated into that screen.
- The Market Participant will be able to modify the data presented on the screen, and then submit the data for scheduling by pressing the “Save” button.
- WEX will validate the submitted data in the same way as for manually entered data. Any error found will be reported back to the Market Participant. Upon successful submission, the Market Participant will be given a confirmation identifier for auditing and tracking purposes.

A high-level sequence diagram shown in Figure 1 illustrates the process of uploading a data file into WebExchanger.

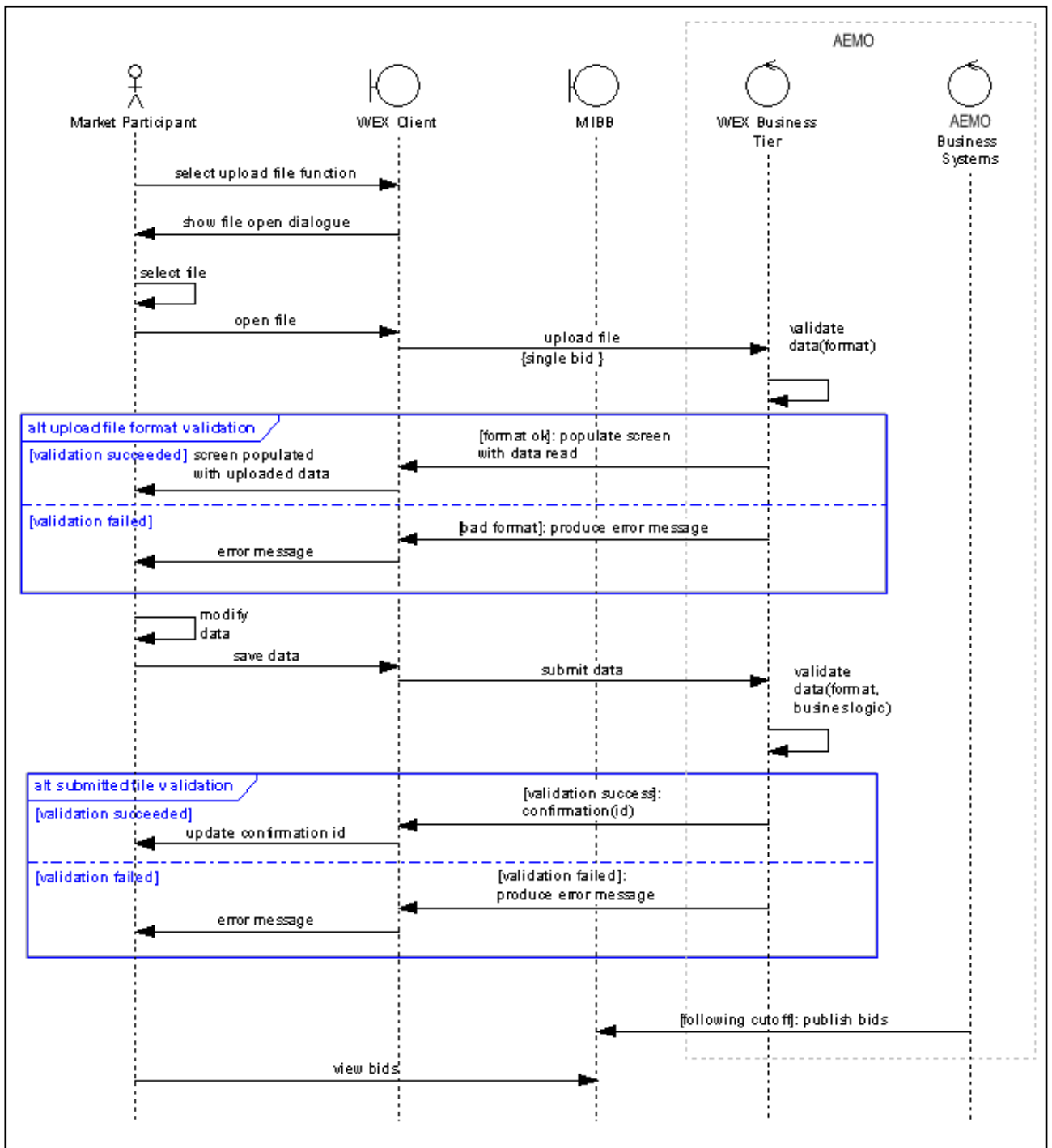
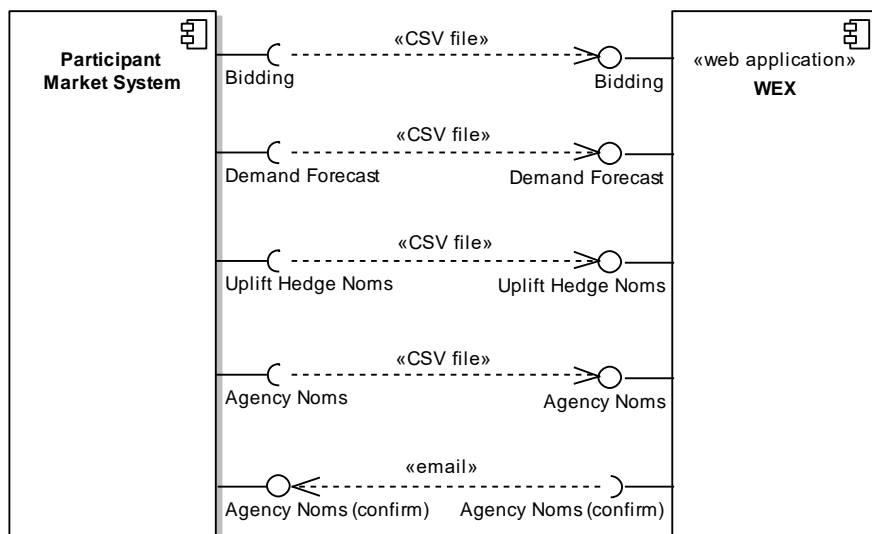

Figure 1 File upload overview sequence diagram for a bid

The individual interfaces that comprise the file upload functionality are:

- Bidding interface – submission of injection and withdrawal bid details for current gas day, day ahead, two days ahead, and standing bid data.

- Demand forecast interface – submission of Market Participant total and site specific demand forecasts for current gas day, day ahead, two days ahead and standing demand forecast.
- Injection hedge nominations interface – submission of injection hedge nominations by CPP, and AMIQ renominations for the current gas day.
- Agency injection hedge nominations interface – submission of agency injection hedge nominations. Note that the withdrawal of agency nominations will have to be performed manually via the appropriate WebExchanger user interface. Confirmations and notifications will be delivered by email.
- AMDQ Nomination Interface – submission of AMDQ nominations during the gas day.



**Figure 2 AEMO provided CSV interfaces**

In addition to upload of CSV files that can be used only to populate browser screens, several web services interfaces are exposed via WebExchanger. Refer to Section 5, page 55 for the detailed specification.

## 2.2 General Requirements

### 2.2.1 File format

Any uploaded file must be in 7-bit ASCII format. Non-printable characters should not be used. No Unicode formats should be used.

### 2.2.2 Line delimiters

Lines in the uploaded file should be delimited by a combination of Carriage Return (CR, ASCII code decimal 12) and Line Feed characters (LF, ASCII code decimal 10). This combination is chosen to cater for the “lowest common denominator” in



producing CSV files, the Microsoft® Excel™ application that uses this behaviour as default.

### 2.2.3 Field delimiters

Fields in a row must be delimited by commas (ASCII code decimal 44).

The last field in the row must be followed the field delimiter (comma) and a line delimiter (CR+LF).

Note: this is in line with Uncontrolled Withdrawal File format (1998) that requires every field, including the last field in a row, to be comma-delimited.

### 2.2.4 Optional fields

If a field is declared as optional its value needs not to be specified, however the field delimiter must be present.

### 2.2.5 Treatment of literals

The CSV import application must be able to parse literals irrespectively whether they are surrounded by double-quotes, single-quotes, or not. Commas must not be used in the literal.

A CSV parser will interpret the following CSV file rows analogously:

```
123,"This is a sample field",456,  
123,'This is a sample field',456,  
123,This is a sample field,456,
```

### 2.2.6 Leading and trailing spaces

In the case of numeric values the use of a leading, embedded or trailing space is inappropriate. Spaces should not be used where a value has a Numeric characteristic.

Where the value has a “text” characteristic that by its nature it can have a space or spaces as part of the structure, only embedded spaces are permitted. Leading and trailing space-characters immediately adjacent to the comma field separators should not be included in the CSV file. Therefore “John Citizen”... resolves to ---,John Citizen,--- or ---,”John Citizen”,---.

Where values must have a leading or trailing spaces as a valid part of the data it must be delimited with double-quote characters. In this way it indicates that the leading and trailing spaces are a component part of the data for example:

```
---,” John Citizen ”,---
```

### 2.2.7 Tab characters

Tab characters shall not be used in CSV files.

### 2.2.8 Special characters

The use of CDATA (non-parsed character data characters “<”, “>”, “&” and hexadecimal characters is prohibited. This is in view of potential use of aseXML carrying CSV data as per this specification.

## 2.2.9 Positive and negative numeric values

Positive numbers in CSV file shall be unsigned. Negative numbers shall be prefixed with a negative sign.

## 2.2.10 Leading and trailing zeroes

There shall be no leading zeroes in numeric values unless a specific data format requires this. Trailing zeroes are allowed and will be ignored, if provided,

## 2.2.11 Data dictionary

Table 1 Field types

<b>Field type</b>	<b>Description</b>	
AgencyNomActivityDescriptor	<b>Value</b>	<b>Description</b>
	Injection nominated	An injection has been nominated by injecting Market Participant.
	Nomination confirmed	Recipient Market Participant has confirmed an injection nomination.
	Nomination withdrawn	Injecting Market Participant has withdrawn an injection nomination.
	Withdrawal confirmed	Withdrawn injection nomination has been confirmed by recipient Market Participant.
ApportionmentMethodDescriptor	<b>Value</b>	<b>Description</b>
	PREF	Use “preference” apportionment method for under-injections for agency injection hedge nominations.
	PROR	Use “prorata” apportionment method for under-injections for agency injection hedge nominations.
DateType	<p>All date fields must be specified using the following format:</p> <ul style="list-style-type: none"> <li>• dd mmm ccyy</li> </ul> <p>Date value must be padded with zeroes up to 2 digits. Shortened, first three letters of the month name (<i>mmm</i>), case-insensitive.</p> <p>Example:</p> <pre>01 dec 2006 01 DEC 2006</pre> <p>All the above examples will be interpreted in the same way, as 1<sup>st</sup> of December 2006.</p>	

<b>Field type</b>	<b>Description</b>	
	<p>Note, gas day, rather than calendar date is used across this document, unless specifically stated that a calendar date must be used. That is, a <u>10<sup>th</sup> October 2006 gas day</u> starts at 6am on 10<sup>th</sup> of October 2006 carries on until 5:59am of 11<sup>th</sup> of October 2006.</p>	
FileTypeDescriptor	<b>Value</b>	<b>Description</b>
	INJ	Injection bid data
	WDL	Withdrawal bid data
	DFN	Demand forecast, non-site specific
	DFS	Demand forecast, site specific
	IHN	Injection hedge nomination
	AIH	Agency injection hedge nominations
MIRNType	Alphanumeric, 10-characters	
OrderType	An integer value starting with 1, used to indicate the order of preference if the “preference” method of apportionment is used for agency injection hedge nomination.	
ParticipantDescriptor	As per AEMO organisation register’s participant identifier. This is a unique numeric identifier assigned to all participants by AEMO. The identifier is currently used by all MIBB reports and is already known to every participant.	
PriceType	<p>Prices are to be defined in Australian Dollars, with 4 digits after the decimal point. Must be right-padded with zeroes up to 4 digits.</p> <p>Example:</p> <pre>5.1234 3.1000</pre>	
QuantityAbsType	<p>Absolute quantity to be defined in GJ. No decimal places are allowed.</p> <p>Example:</p> <pre>20 3000</pre>	
QuantityRelType	Relative quantity specified as percentage of the predetermined value (for example the value of a certificate). A percentage sign “%” must follow the value. Values in the range from 0 to 100	

<b>Field type</b>	<b>Description</b>	
	inclusive are allowed with 4 digits after decimal point. Example: 15.1234% 0.0000% 100.0000%	
SchedIntervalDescriptor	<b>Value</b>	<b>Description</b>
	1	Beginning of Day (BOD), currently defined as 6am
	2	Fixed scheduling time for current gas day, currently defined as 10am
	3	Fixed scheduling time for current gas day, currently defined as 2pm
	4	Fixed scheduling time for current gas day, currently defined as 6pm
	5	Fixed scheduling time for current gas day, currently defined as 10pm
TimeType	All time fields must be specified using the 24-hour clock, in AEST. Values in time fields specify the beginning of the hour. Hours and minutes must be padded with zeroes up to 2 digits. Example: 06:00 15:00	

## 2.2.12 File naming convention

The uploaded file name has no relevance to AEMO and it should be used by Market Participants to signify the file contents or for auditing purposes. Conversely, the file extension should be set in accordance with the following table:

<b>File extension</b>	<b>Description</b>
csv	Files containing comma-separated values
xml	Files containing complete or fragment XML data

## 2.2.13 File header

Every uploaded file must consist of a header and a body. The header must be separated from the body by a blank line, i.e. CR + LF.

The header will facilitate the determination of the uploaded file type and will allow AEMO to validate the contents of the file in relation to the corresponding WebExchanger function.

The body contains one or more rows of data to be populated into the appropriate WebExchanger screen.

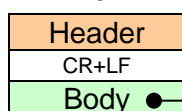

- Bidding interface, Section 2.3
- Demand forecast interface, Section 2.4
- Injection hedge nomination interface, Section 2.5
- Agency injection hedge nomination, Section 2.6
- AMDQ nomination interface, Section 2.7

The fields of the CSV file header are as specified below.

Table 2 Upload file header

<b>Field name</b>	<b>Field type</b>	<b>M/O/NR</b>	<b>Description</b>
file_type	FileTypeDescriptor	M	Indicator of the type of data stored in the uploaded file.
market_participant	ParticipantDescriptor	M	Identifier of the Market Participant uploading the file, as specified by AEMO. It is expected that during the file validation this identifier will be matched to the user id used for login. Although redundant, it provides an additional checkpoint.

<b>Field name</b>	<b>Field type</b>	<b>M/O/NR</b>	<b>Description</b>
commencement_date	DateType	O	If supplied without Termination Date, then it will be considered as the selected gas day. If used together with Termination Date, then it is treated a commencement date for standing selection <sup>2</sup> .
termination_date	DateType	O	If supplied, then signifies the termination date for standing selection. The termination date is not inclusive, and must be at least one day ahead of the commencement date.
mirn	MIRNType	See specific interface requirements	Mandatory/optional. When supplied, the data in the uploaded file are considered against the meter specified by this MIRN. See relevance of this field in the context of specific interfaces.
apportionment_method	ApportionmentMethodDescriptor	See specific interface requirements	Mandatory for agency injection hedge nominations interface. Optional for all other interfaces.

---

<sup>2</sup> If both commencement\_date and termination\_date are not supplied, then data from the uploaded file are just used to populate the corresponding bid, demand forecast or injection hedge nomination screen, but not the date.

## 2.3 Bidding Interface

A Market Participant will have an ability to submit bids information via the file upload facility provided within the WEX user interface.

The following should clarify the terminology used for the description of the bidding information:

- *Bid Set* – a collection of up to 5 *Bids* for a specific gas day,
- *Bid* – a collection of up to 10 *Bid Steps* for the specific scheduling horizon,
- *Bid Step* – a price-quantity step in a *Bid*.

Below is a UML class diagram<sup>3</sup> that illustrates the relationships between bidding information elements.

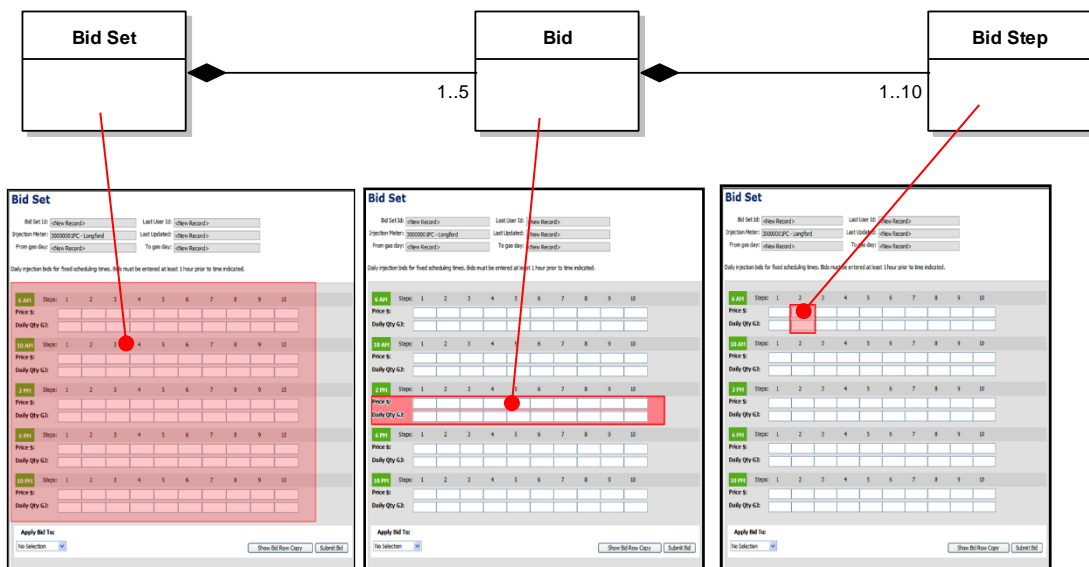

Figure 3 Bidding terminology

The Market Participant selects the file upload function by pressing the corresponding button on the bidding screen. This will activate the File Open dialogue, which the participant will use to locate a file populated with bidding data. The format of the file is specified in this section.

Uploaded information is read into WebExchanger and validated against data format requirements. If the format validation is successful, the information is populated back into the current bidding screen. The Market Participant will have to save the

<sup>3</sup> On a class diagram, a rectangle represents an entity. Solid diamond on the line connecting entities, called an Association or a Relationship, indicates the containment or the aggregation. Entity’s multiplicity is shown as a number at the association end closer to the entity. An example of reading the diagram above would be: "A *Bid Set* may be composed of at least one and up to 5 *Bids*, where each *Bid* may be composed of at least one and up to 10 *Bid Steps*."

data shown on the screen for WEX to perform business validation of the bidding data.

If an error is found with the uploaded file format, then WEX displays an error and allows the participant to select another file.

Only a single bid is allowed. WebExchanger will use the provided data to populate the appropriate scheduling interval.

Both bid parts, i.e. Step Price and Step Quantity must be defined.

No gaps are allowed in bid steps, for example if *bid\_step\_02* is defined then *bid\_step\_01* must be defined as well. The field *bid\_step\_01* must be always defined first.

For injection bids, the injected quantity must be equal or increased with the corresponding price increased. For withdrawal bids, the withdrawal quantity must be equal or decreased with the corresponding prices increased. The bid steps must be sorted in the CSV file, with quantities increasing.

For injection bids, for reschedules on the current gas day, the quantity of gas of a rebid associated with the highest bid step cannot be less than what has been scheduled for the current and preceding scheduling intervals at the relevant injection point for the given participant i.e. the updated bid quantity for a subsequent schedule must be greater than or equal to the sum of the operating schedule quantities for all the preceding and the current scheduling intervals.

For withdrawal bids, for reschedules on the current gas day, the quantity of gas of a rebid associated with the lowest bid step cannot be less than what has been scheduled for the current and preceding scheduling intervals at the relevant withdrawal point for the given participant i.e. the updated bid quantity for a subsequent schedule must be greater than or equal to the sum of the operating schedule quantities for all the preceding and the current scheduling intervals.

### 2.3.1 Injection Bid Interface Definition

<i>Interface type</i>	<i>Data type</i>	<i>From</i>	<i>To</i>	<i>Comments</i>
File	CSV	Participant	AEMO	

File header fields are to be set as per the following table:

<i>Field name</i>	<i>Field type</i>	<i>M/O/NR</i>	<i>Field value / example</i>
file_type	FileTypeDescriptor	M	INJ
market_participant	ParticipantDescriptor	M	99
commencement_date	DateType	O	
termination_date	DateType	O	
mirn	MIRNType	M	1234567890



<b>Field name</b>	<b>Field type</b>	<b>M/O/NR</b>	<b>Field value / example</b>
apportionment_method	ApportionmentMethod Descriptor	NR	

**Table 3 Injection bid fields**

<b>Field name</b>	<b>Field type</b>	<b>M/O/NR</b>	<b>Description</b>
bid_step_01_price	PriceType	M	1 <sup>st</sup> bid step price
bid_step_01_quantity	QuantityAbsType	M	1 <sup>st</sup> bid step quantity
bid_step_02_price	PriceType	O	2 <sup>nd</sup> bid step price
bid_step_02_quantity	QuantityAbsType	O	2 <sup>nd</sup> bid step quantity
bid_step_03_price	PriceType	O	3 <sup>rd</sup> bid step price
bid_step_03_quantity	QuantityAbsType	O	3 <sup>rd</sup> bid step quantity
bid_step_04_price	PriceType	O	4 <sup>th</sup> bid step price
bid_step_04_quantity	QuantityAbsType	O	4 <sup>th</sup> bid step quantity
bid_step_05_price	PriceType	O	5 <sup>th</sup> bid step price
bid_step_05_quantity	QuantityAbsType	O	5 <sup>th</sup> bid step quantity
bid_step_06_price	PriceType	O	6 <sup>th</sup> bid step price
bid_step_06_quantity	QuantityAbsType	O	6 <sup>th</sup> bid step quantity
bid_step_07_price	PriceType	O	7 <sup>th</sup> bid step price
bid_step_07_quantity	QuantityAbsType	O	7 <sup>th</sup> bid step quantity
bid_step_08_price	PriceType	O	8 <sup>th</sup> bid step price
bid_step_08_quantity	QuantityAbsType	O	8 <sup>th</sup> bid step quantity
bid_step_09_price	PriceType	O	9 <sup>th</sup> bid step price.
bid_step_09_quantity	QuantityAbsType	O	9 <sup>th</sup> bid step quantity
bid_step_10_price	PriceType	O	10 <sup>th</sup> bid step price.
bid_step_10_quantity	QuantityAbsType	O	10 <sup>th</sup> bid step quantity
minimum_daily_quantity (Not available through Browser Interface)	QuantityAbsType	O	Minimum daily quantity field is not available through the Browser Interface and it can now only be zero if submitted through csv file upload or WebServices. If omitted, WebExchanger will consider as zero-value.

<b>Field name</b>	<b>Field type</b>	<b>M/O/NR</b>	<b>Description</b>
scheduling_interval	SchedIntervalDescriptor	O	Scheduling interval to populate the bid details into. If omitted, then the first scheduling interval will be assumed.

Price-quantity steps must be specified in pairs. That is, if price for a particular step has been specified, then the quantity for the same step must be specified too. The opposite is also true: if the quantity is specified, the corresponding step's price field becomes mandatory.

### 2.3.2 Withdrawal Bid Interface Definition

<b>Interface type</b>	<b>Data type</b>	<b>From</b>	<b>To</b>	<b>Comments</b>
File	CSV	Participant	AEMO	

File header fields are to be set as per following table:

<b>Field name</b>	<b>Field type</b>	<b>M/O/NR</b>	<b>Field value / example</b>
file_type	FileTypeDescriptor	M	WDL
market_participant	ParticipantDescriptor	M	99
commencement_date	DateType	O	
termination_date	DateType	O	
mirn	MIRNType	M	1234567890
apportionment_method	ApportionmentMethodDescriptor	NR	

Table 4 Withdrawal bid fields

<b>Field name</b>	<b>Field type</b>	<b>M/O/NR</b>	<b>Description</b>
bid_step_1_price	PriceType	M	1 <sup>st</sup> bid step price
bid_step_01_quantity	QuantityAbsType	M	1 <sup>st</sup> bid step quantity
bid_step_02_price	PriceType	O	2 <sup>nd</sup> bid step price
bid_step_02_quantity	QuantityAbsType	O	2 <sup>nd</sup> bid step quantity
bid_step_03_price	PriceType	O	3 <sup>rd</sup> bid step price
bid_step_03_quantity	QuantityAbsType	O	3 <sup>rd</sup> bid step quantity
bid_step_04_price	PriceType	O	4 <sup>th</sup> bid step price
bid_step_04_quantity	QuantityAbsType	O	4 <sup>th</sup> bid step quantity

<b>Field name</b>	<b>Field type</b>	<b>M/O/NR</b>	<b>Description</b>
bid_step_05_price	PriceType	O	5 <sup>th</sup> bid step price
bid_step_05_quantity	QuantityAbsType	O	5 <sup>th</sup> bid step quantity
bid_step_06_price	PriceType	O	6 <sup>th</sup> bid step price
bid_step_06_quantity	QuantityAbsType	O	6 <sup>th</sup> bid step quantity
bid_step_07_price	PriceType	O	7 <sup>th</sup> bid step price
bid_step_07_quantity	QuantityAbsType	O	7 <sup>th</sup> bid step quantity
bid_step_08_price	PriceType	O	8 <sup>th</sup> bid step price
bid_step_08_quantity	QuantityAbsType	O	8 <sup>th</sup> bid step quantity
bid_step_09_price	PriceType	O	9 <sup>th</sup> bid step price
bid_step_09_quantity	QuantityAbsType	O	9 <sup>th</sup> bid step quantity
bid_step_10_price	PriceType	O	10 <sup>th</sup> bid step price
bid_step_10_quantity	QuantityAbsType	O	10 <sup>th</sup> bid step quantity
minimum_daily_quantity (Not available through Browser Interface)	QuantityAbsType	O	Minimum daily quantity field is not available through the Browser Interface and it can now only be zero if submitted through csv file upload or WebServices. If omitted, WebExchanger will consider as zero-value.
scheduling_interval	SchedIntervalDescriptor	O	Scheduling interval to populate the bid details into. If omitted, then the first scheduling interval will be assumed.

### 2.3.3 Examples

An injection standing bid from CleanEnergy for meter 12345678PC with minimum daily quantity of 0 GJ, with all bid steps defined:

```
INJ,99,12 May 2006,15 Jun 2006,12345678PC,,
```

```
2.1230,250,2.3456,300,2.4560,350,2.5670,370,2.6789,390,2.7890,395,2.8981,405,2.9123,410,3.0100,420,3.1000,430,0,,
```

An injection bid from CleanEnergy (participant identifier = 99) for specific gas day for meter 12345678PC with just two bid steps specified, without minimum daily quantity, to be uploaded into 10pm scheduling interval bid:

```
INJ,99,12 May 2006,,1234567890PC,,
```

```
2.1230,250,2.3456,300,,,,,,,,,,,,,5,
```

A withdrawal bid by CleanEnergy with all 10 price-quantity steps specified for a gas day:

```
WDL,99,12 May 2006,,12345678PC,,
```

```
3.5230,250,3.3456,300,3.2560,350,3.1670,370,3.0789,390,2.9890,395,2.8981,405,2.6123,410,2.5100,420,2.2000,430,,,
```

## 2.4 Demand Forecast Interface

Market Participants will have an ability to submit their demand forecasts via the file upload facility incorporated into WEX. A Market Participant selects the file upload function by pressing the file upload button on the demand forecast screen. From the file open dialogue the Market Participant will locate and open the prepared file. WEX will upload the file, validate its format and populate the screen with the uploaded information.

### 2.4.1 Site Specific Demand Forecast

MIRN field in the header is a mandatory field. The absolute value for the first hour is determined by the gas day start time. As the beginning of a gas day is currently defined at 6:00am, the value for *quantity\_at\_hr\_1* will be referred to 6:00am, the *quantity\_at\_hr\_2* to 7:00am, and so forth.

<b>Interface type</b>	<b>Data type</b>	<b>From</b>	<b>To</b>	<b>Comments</b>
File	CSV	Participant	AEMO	

File header fields are to be set as per following table:

<b>Field name</b>	<b>Field type</b>	<b>M/O/NR</b>	<b>Field value / example</b>
file_type	FileTypeDescriptor	M	DFS
market_participant	ParticipantDescriptor	M	99
commencement_date	DateType	O	
termination_date	DateType	O	
mirn	MIRNType	M	1234567890

<b>Field name</b>	<b>Field type</b>	<b>M/O/NR</b>	<b>Field value / example</b>
apportionment_method	ApportionmentMethod Descriptor	NR	

Table 5 Site specific demand forecast fields

<b>Field name</b>	<b>Field type</b>	<b>M/O/NR<sup>4</sup></b>	<b>Description</b>
quantity_at_hr_01	QuantityAbsType	M	Forecasted demand for the beginning of 1 <sup>st</sup> hour.
quantity_at_hr_02	QuantityAbsType	M	Forecasted demand for the beginning of 2 <sup>nd</sup> hour.
quantity_at_hr_03	QuantityAbsType	M	Forecasted demand for the beginning of 3 <sup>rd</sup> hour.
quantity_at_hr_04	QuantityAbsType	M	Forecasted demand for the beginning of 4 <sup>th</sup> hour.
quantity_at_hr_05	QuantityAbsType	M	Forecasted demand for the beginning of 5 <sup>th</sup> hour.
quantity_at_hr_06	QuantityAbsType	M	Forecasted demand for the beginning of 6 <sup>th</sup> hour.
quantity_at_hr_07	QuantityAbsType	M	Forecasted demand for the beginning of 7 <sup>th</sup> hour.
quantity_at_hr_08	QuantityAbsType	M	Forecasted demand for the beginning of 8 <sup>th</sup> hour.
quantity_at_hr_09	QuantityAbsType	M	Forecasted demand for the beginning of 9 <sup>th</sup> hour.
quantity_at_hr_10	QuantityAbsType	M	Forecasted demand for the beginning of 10 <sup>th</sup> hour.

<sup>4</sup> Field is mandatory (M) for day ahead, two days ahead, standing forecast and 06:00am forecast for current gas day. Field is not required (NR) for historic hours for intra-day forecasts for current gas day.

<b>Field name</b>	<b>Field type</b>	<b>M/O/NR<sup>4</sup></b>	<b>Description</b>
quantity_at_hr_11	QuantityAbsType	M	Forecasted demand for the beginning of 11 <sup>th</sup> hour.
quantity_at_hr_12	QuantityAbsType	M	Forecasted demand for the beginning of 12 <sup>th</sup> hour.
quantity_at_hr_13	QuantityAbsType	M	Forecasted demand for the beginning of 13 <sup>th</sup> hour.
quantity_at_hr_14	QuantityAbsType	M	Forecasted demand for the beginning of 14 <sup>th</sup> hour.
quantity_at_hr_15	QuantityAbsType	M	Forecasted demand for the beginning of 15 <sup>th</sup> hour.
quantity_at_hr_16	QuantityAbsType	M	Forecasted demand for the beginning of 16 <sup>th</sup> hour.
quantity_at_hr_17	QuantityAbsType	M	Forecasted demand for the beginning of 17 <sup>th</sup> hour.
quantity_at_hr_18	QuantityAbsType	M	Forecasted demand for the beginning of 18 <sup>th</sup> hour.
quantity_at_hr_19	QuantityAbsType	M	Forecasted demand for the beginning of 19 <sup>th</sup> hour.
quantity_at_hr_20	QuantityAbsType	M	Forecasted demand for the beginning of 20 <sup>th</sup> hour.
quantity_at_hr_21	QuantityAbsType	M	Forecasted demand for the beginning of 21 <sup>st</sup> hour.
quantity_at_hr_22	QuantityAbsType	M	Forecasted demand for the beginning of 22 <sup>nd</sup> hour.
quantity_at_hr_23	QuantityAbsType	M	Forecasted demand for the beginning of 23 <sup>rd</sup> hour.
quantity_at_hr_24	QuantityAbsType	M	Forecasted demand for the beginning of 24 <sup>th</sup> hour.

## 2.4.2 Non-Site Specific Demand Forecast

This interface is identical to the Site Specific Interface, Section 2.4.1, with the following exception: the header's MIRN field is made optional.

<i>Interface type</i>	<i>Data type</i>	<i>From</i>	<i>To</i>	<i>Comments</i>
File	CSV	Participant	AEMO	

File header fields are to be set as per following table:

<i>Field name</i>	<i>Field type</i>	<i>M/O/NR</i>	<i>Field value / example</i>
file_type	FileTypeDescriptor	M	DFN
market_participant	ParticipantDescriptor	M	99
commencement_date	DateType	O	
termination_date	DateType	O	
Mirn	MIRNType	NR	
apportionment_method	ApportionmentMethodDescriptor	NR	

Table 6 Non-site specific demand forecast fields

<i>Field name</i>	<i>Field type</i>	<i>M/O/NR<sup>4</sup></i>	<i>Description</i>
quantity_at_hr_01	QuantityAbsType	M	Forecasted demand for the beginning of 1 <sup>st</sup> hour.
quantity_at_hr_02	QuantityAbsType	M	Forecasted demand for the beginning of 2 <sup>nd</sup> hour.
quantity_at_hr_03	QuantityAbsType	M	Forecasted demand for the beginning of 3 <sup>rd</sup> hour.
quantity_at_hr_04	QuantityAbsType	M	Forecasted demand for the beginning of 4 <sup>th</sup> hour.
quantity_at_hr_05	QuantityAbsType	M	Forecasted demand for the beginning of 5 <sup>th</sup> hour.
quantity_at_hr_06	QuantityAbsType	M	Forecasted demand for the beginning of 6 <sup>th</sup> hour.

<b>Field name</b>	<b>Field type</b>	<b>M/O/NR<sup>4</sup></b>	<b>Description</b>
quantity_at_hr_07	QuantityAbsType	M	Forecasted demand for the beginning of 7 <sup>th</sup> hour.
quantity_at_hr_08	QuantityAbsType	M	Forecasted demand for the beginning of 8 <sup>th</sup> hour.
quantity_at_hr_09	QuantityAbsType	M	Forecasted demand for the beginning of 9 <sup>th</sup> hour.
quantity_at_hr_10	QuantityAbsType	M	Forecasted demand for the beginning of 10 <sup>th</sup> hour.
quantity_at_hr_11	QuantityAbsType	M	Forecasted demand for the beginning of 11 <sup>th</sup> hour.
quantity_at_hr_12	QuantityAbsType	M	Forecasted demand for the beginning of 12 <sup>th</sup> hour.
quantity_at_hr_13	QuantityAbsType	M	Forecasted demand for the beginning of 13 <sup>th</sup> hour.
quantity_at_hr_14	QuantityAbsType	M	Forecasted demand for the beginning of 14 <sup>th</sup> hour.
quantity_at_hr_15	QuantityAbsType	M	Forecasted demand for the beginning of 15 <sup>th</sup> hour.
quantity_at_hr_16	QuantityAbsType	M	Forecasted demand for the beginning of 16 <sup>th</sup> hour.
quantity_at_hr_17	QuantityAbsType	M	Forecasted demand for the beginning of 17 <sup>th</sup> hour.
quantity_at_hr_18	QuantityAbsType	M	Forecasted demand for the beginning of 18 <sup>th</sup> hour.
quantity_at_hr_19	QuantityAbsType	M	Forecasted demand for the beginning of 19 <sup>th</sup> hour.
quantity_at_hr_20	QuantityAbsType	M	Forecasted demand for the beginning of 20 <sup>th</sup> hour.



<i>Field name</i>	<i>Field type</i>	<i>M/O/NR<sup>4</sup></i>	<i>Description</i>
quantity_at_hr_21	QuantityAbsType	M	Forecasted demand for the beginning of 21 <sup>st</sup> hour.
quantity_at_hr_22	QuantityAbsType	M	Forecasted demand for the beginning of 22 <sup>nd</sup> hour.
quantity_at_hr_23	QuantityAbsType	M	Forecasted demand for the beginning of 23 <sup>rd</sup> hour.
quantity_at_hr_24	QuantityAbsType	M	Forecasted demand for the beginning of 24 <sup>th</sup> hour.

### 2.4.3 Examples

Site specific demand forecast for a specific gas day from CleanEnergy:

```
DFS,99,12 May 2006,,12345678PC,,
10,10,10,6,5,6,7,8,9,10,10,10,10,10,15,19,18,15,15,10,10,10,10,10,
```

Non-site specific demand forecast for a specific day from CleanEnergy:

```
DFN,99,12 May 2006,,,,
10,10,10,6,5,6,7,8,9,10,10,10,10,10,15,19,18,15,15,10,10,10,10,10,
```

## 2.5 Injection Hedge Nomination Interface

Market Participants will have an ability to submit their injection hedge nominations via the file upload facility provided by WebExchanger. The list of injection sites must be incorporated in the file as specified below and can be expanded to include any new injection sites.

WebExchanger will only validate uploaded file for data format.

Sum of all AMIQ fields must be less or equal to 100%.

Participants are able to update their nominations of AMIQ during the gas day. AMIQ values submitted for prior and current scheduling intervals are locked in. Values for all 5 scheduling intervals are mandatory, however, regardless of the values provided for prior and current scheduling intervals, the system will retain (and display) the previously locked in values. Only values for future scheduling intervals can be modified.

## 2.5.1 File format

Note: it might be beneficial to split the list of sites and profile information, so that addition or removal of sites will have less impact on participant systems

<i>Interface type</i>	<i>Data type</i>	<i>From</i>	<i>To</i>	<i>Comments</i>
File	CSV	Participant	AEMO	

File header fields are to be set as per following table:

<i>Field name</i>	<i>Field type</i>	<i>M/O/NR</i>	<i>Field value / example</i>
file_type	FileTypeDescriptor	M	IHN
market_participant	ParticipantDescriptor	M	99
commencement_date	DateType	O	
termination_date	DateType	O	
mirn	MIRNType	NR	
apportionment_method	ApportionmentMethodDescriptor	NR	

**Table 7 Injection hedge nomination fields**

<i>Field name</i>	<i>Field type</i>	<i>M/O/NR</i>	<i>Field value / example</i>
Close Proximity Point Description	CPPDescriptor	O	CPP Description e.g. Longford, Iona, Culcairn, <a href="#">Bass Gas</a>
CPP Quantity	QuantityAbsType	O	Absolute injection quantity (the IHN amount) to be used as injection hedge for this Close Proximity Point.
Repeat this entry for every Close Proximity point.			

<i>Field name</i>	<i>Field type</i>	<i>M/O/NR</i>	<i>Description</i>
amiq_for_interval_1	QuantityRelType	M	AMIQ value for the first scheduling interval.
amiq_for_interval_2	QuantityRelType	M	AMIQ value for the second scheduling interval.
amiq_for_interval_3	QuantityRelType	M	AMIQ value for the third scheduling interval.
amiq_for_interval_4	QuantityRelType	M	AMIQ value for the fourth scheduling interval.

<i>Field name</i>	<i>Field type</i>	<i>M/O/NR</i>	<i>Description</i>
amiq_for_interval_5	QuantityRelType	M	AMIQ value for the remainder of gas day.

Specifying an injection quantity for any of the injection sites makes all *amiq\_for\_interval\_N* fields mandatory. The opposite is also true: specification of values in *amiq\_for\_interval\_N* results in at least one injection site specification mandatory.

## 2.5.2 Examples

Injection hedge nomination and AMIQ by CleanEnergy (participant identifier = 99) for a specific gas day. All values are absolute quantities.

```
IHN,99,12 May 2006,,,,
Longford,100
Culcairn,20
Bass Gas,50
Iona,40
25.0000%,25.0000%,25.0000%,10.0000%,15.0000%,
```

Standing injection hedge nomination and AMIQ by CleanEnergy:

```
IHN,99,12 May 2006,15 Jun 2006,,,
Longford,100
Culcairn,20
Bass Gas,50
Iona,40
25.0000%,25.0000%,25.0000%,10.0000%,15.0000%,
```

Note:

For a list of Close Proximity Points and Meter Description values please see the document “WebExchanger – Defined Data Lists” which can be found in the Documents folder in the Public Area of the MIBB (refer Related Documents Table).

## 2.6 Agency Injection Hedge Nomination Interface

This is multi-party communications, with AEMO acting as hub. The Agency injection hedge nomination facility in WebExchanger allows for registering a request by an injecting party for an agency nomination for market settlement.

The process of submitting an agency nomination is as follows:

- An Injecting Market Participant submits an agency nomination consisting of:

- a. Recipient market participant id, and
  - b. Nominated injection quantity. Preference order must be provided if the preference apportionment method is chosen.
- The nomination information can be either manually entered or uploaded as a CSV file using the format as defined in Table 8. WebExchanger will validate the format of the provided data, if uploaded as CSV file.
- A nomination by an Injecting Market Participant will trigger the generation of a number of email notifications:
  - a. To every nominated Recipient Market Participant requesting a confirmation of the nomination. The email format is specified in 2.6.3.
  - b. To Injecting Market Participant to notify that the counterparty nominated for a specified quantity has requested a confirmation. The email format is specified in 2.6.3.
- A Recipient Market Participant confirms nominations. This triggers the generation of several email notifications:
  - a. To every Injecting Market Participant asked for nomination confirmation. The email format is specified in 2.6.3.
  - b. To Recipient Market Participant indicating that confirmation emails have been sent out. The email format is specified in 2.6.3.

This process is further illustrated in the following sequence diagram:

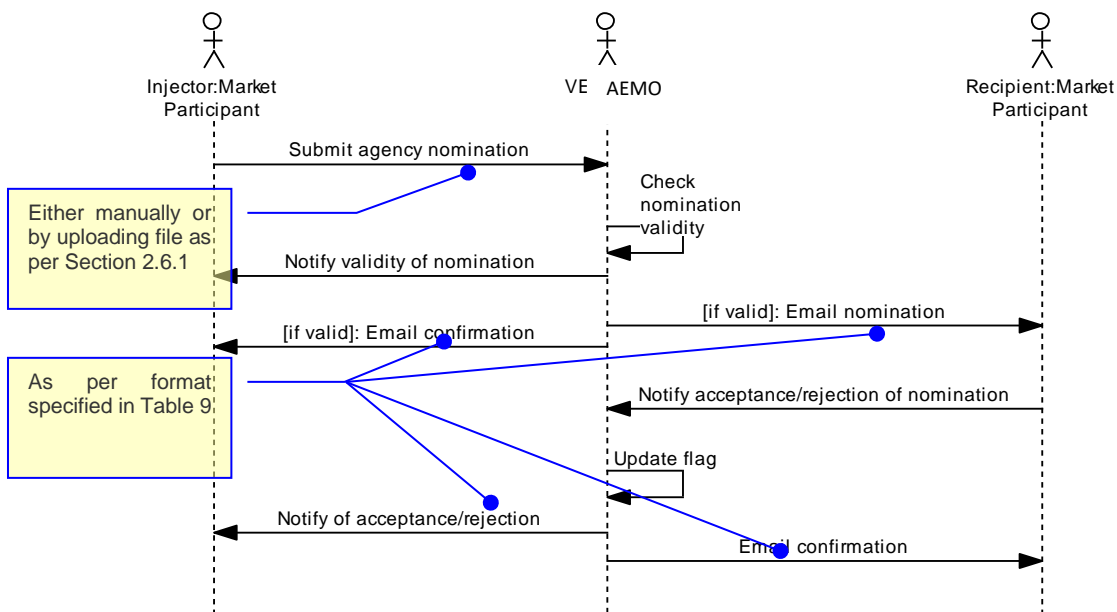

**Figure 4 Agency injection hedge nomination sequence diagram**

If the Injecting Market Participant decides to withdraw a nomination, the withdrawal will result in one of the following scenarios. The scenario to be executed is subject to the state of the nomination as outlined below:

- If the Recipient Market Participant has already confirmed the nomination, then WebExchanger generates a withdrawal nomination request email. The corresponding Recipient Market Participant must confirm the withdrawal via the corresponding WebExchanger screen.
- If the Recipient Market Participant has not yet confirmed the nomination, then a withdrawal notification email is generated and sent out to Recipient Market Participant.

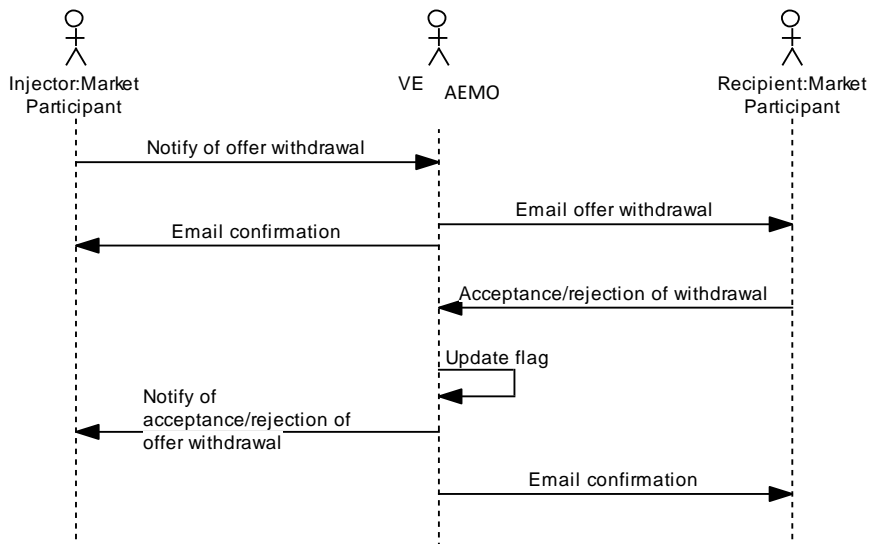

Figure 5 Agency injection hedge nomination withdrawal

The following UML state transition diagram<sup>5</sup> further illustrates the lifecycle of an agency injection nomination.

<sup>5</sup> A rounded rectangle represents a finite *state* in which a Nomination can be at any point in time. Lines between the *states* indicate *transitions* from one state to another. Text along the *transition* line is composed of the *trigger* (the event that causes the transition) and the *action* – the activity that is associated with that particular *transition*.

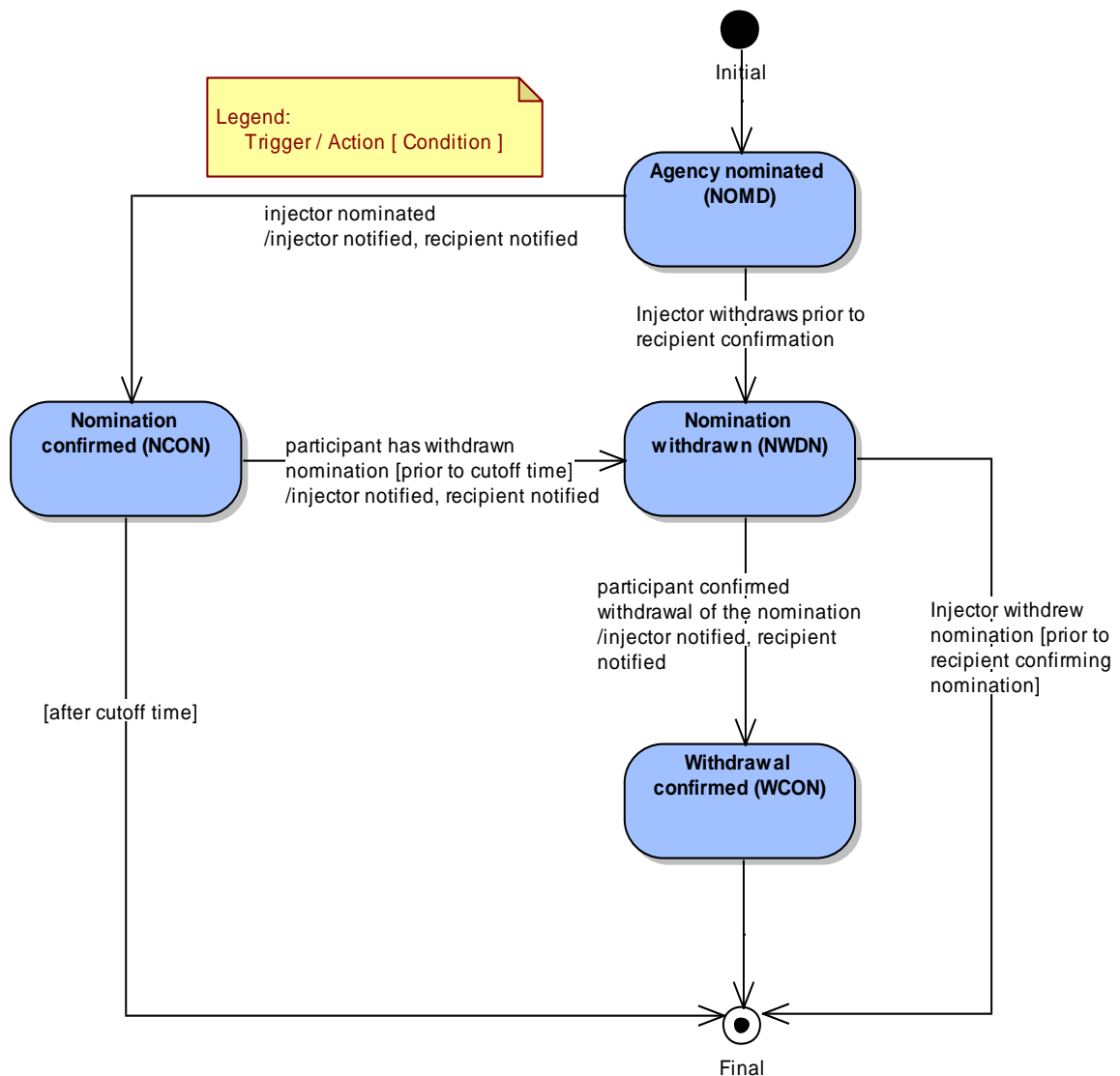

Figure 6 Agency injection nomination lifecycle

### 2.6.1 File format

Up to 10 nominations can be specified in a single file.

This interface will only provide for uploading agency nominations. The nomination confirmations, withdrawals, and withdrawal confirmations do not form part of this interface.

Interface type	Data type	From	To	Comments
File	CSV	Participant	AEMO	

File header fields are to be set as per the following table:

<b>Field name</b>	<b>Field type</b>	<b>M/O/NR</b>	<b>Field value / example</b>
file_type	FileTypeDescriptor	M	AIH
market_participant	ParticipantDescriptor	M	99
commencement_date	DateType	O	
termination_date	DateType	O	
Close Proximity Point	CPPDescriptorType	M	CPP Description e.g. Longford, Iona, Culcairn, <b>Bass Gas</b>
apportionment_method	ApportionmentMethod Descriptor	M	PREF or PROR

The following format validations rules will be applied to the uploaded file:

- All mandatory fields are provided, i.e. Market Participant Id and Nominated Quantity are both specified. If “preference” apportionment method is selected, then the Preference Order must be provided.
- There are no gaps in preference order defined, i.e. preference order numbers are monotonically increasing, starting with 1.

**Table 8 Agency injection hedge nomination fields**

<b>Field name</b>	<b>Field type</b>	<b>M/O/NR</b>	<b>Description</b>
nominated_market_participant_01_id	ParticipantDescriptor	M	Market Participant nominated to receive gas.
preference_order_for_market_participant_01	OrderType	M	Mandatory, if “preference” method in the file header is specified.  Optional, if “prorata” method in the file header is specified.
nominated_quantity_01	QuantityAbsType	M	Nominated injection quantity of gas for the specified Market Participant.
nominated_market_participant_02_id	ParticipantDescriptor	O	Id of Market Participant nominated for injection.

<b>Field name</b>	<b>Field type</b>	<b>M/O/NR</b>	<b>Description</b>
preference_order_for_market_participant_02	OrderType	O	Optional if no Market Participant is nominated, or Market Participant is nominated and “prorata” method is specified.  Mandatory if Market Participant is nominated and “preference” method is specified.
nominated_quantity_02	QuantityAbsType	O	Optional, if Market Participant is not nominated.  Mandatory otherwise.
nominated_market_participant_03_id	ParticipantDescriptor	O	As per “Nominated Market Participant Id 2”.
preference_order_for_market_participant_03	OrderType	O	As per “Preference Order for Market Participant Id 2”.
nominated_quantity_03	QuantityAbsType	O	As per “Nominated Quantity 2”.
nominated_market_participant_04_id	ParticipantDescriptor	O	As per “Nominated Market Participant Id 2”.
preference_order_for_market_participant_04	OrderType	O	As per “Preference Order for Market Participant Id 2”.
nominated_quantity_04	QuantityAbsType	O	As per “Nominated Quantity 2”.
nominated_market_participant_05_id	ParticipantDescriptor	O	As per “Nominated Market Participant Id 2”.
preference_order_for_market_participant_05	OrderType	O	As per “Preference Order for Market Participant Id 2”.
nominated_quantity_05	QuantityAbsType	O	As per “Nominated Quantity 2”.
nominated_market_participant_06_id	ParticipantDescriptor	O	As per “Nominated Market Participant Id 2”.
preference_order_for_market_participant_06	OrderType	O	As per “Preference Order for Market Participant Id 2”.



<b>Field name</b>	<b>Field type</b>	<b>M/O/NR</b>	<b>Description</b>
nominated_quantity_06	QuantityAbsType	O	As per “Nominated Quantity 2”.
nominated_market_participant_07_id	ParticipantDescriptor	O	As per “Nominated Market Participant Id 2”.
preference_order_for_market_participant_07	OrderType	O	As per “Preference Order for Market Participant Id 2”.
nominated_quantity_07	QuantityAbsType	O	As per “Nominated Quantity 2”.
nominated_market_participant_08_id	ParticipantDescriptor	O	As per “Nominated Market Participant Id 2”.
preference_order_for_market_participant_08	OrderType	O	As per “Preference Order for Market Participant Id 2”.
nominated_quantity_08	QuantityAbsType	O	As per “Nominated Quantity 2”.
nominated_market_participant_09_id	ParticipantDescriptor	O	As per “Nominated Market Participant Id 2”.
preference_order_for_market_participant_09	OrderType	O	As per “Preference Order for Market Participant Id 2”.
nominated_quantity_09	QuantityAbsType	O	As per “Nominated Quantity 2”.
nominated_market_participant_10_id	ParticipantDescriptor	O	As per “Nominated Market Participant Id 2”.
preference_order_for_market_participant_10	OrderType	O	As per “Preference Order for Market Participant Id 2”.
nominated_quantity_10	QuantityAbsType	O	As per “Nominated Quantity 2”.

Injection hedge nominations in the file are organised into 10 groups. Each group consists of:

- Nominated market participant,
- Preference order for the nominated market participant, and
- Nominated quantity

As a minimum, the first group must be specified. Within any group, a *preference\_order\_for\_market\_participant\_N* field is mandatory if the *apportionment\_method* in the file header is specified as “PROR”, otherwise the field will be treated as optional.

## 2.6.2 Examples

Agency injection hedge nomination file that uses “preference” method of apportionment for 4 participants for a specified gas day:

```
AIH,99,12 May 2006,,Longford,PREF,
```

```
MP_ID_1,4,50,MP_ID_2,1,70,MP_ID_3,2,20,MP_ID_4,3,50,,,,,,,,,,,,,
'''
```

Agency injection hedge nomination file that uses “prorata” method of apportionment for 3 participants:

```
AIH,99,12 May 2006,,Culcairn,PROR,
```

```
MP_ID_1,,50,MP_ID_2,,70,MP_ID_3,,20,,,,,,,,,,,,,
'''
```

Note:

For a list of Close Proximity Points and Meter Description values please see the document “WebExchanger – Defined Data Lists” which can be found in the Documents folder in the Public Area of the MIBB (refer Related Documents Table).

### 2.6.3 Notification email format

The confirmation emails generated by WebExchanger towards Market Participants should follow the same format, so that some automation can be achieved by parsing the email message fields. The fields of interest here will be the email message subject and email body fields.

The subject field has been designed to allow the agency nomination counterparties to determine the source of the message and its purpose. To improve readability, the subject fields will be separated by a combination of **space** (ASCII code decimal 32) - **minus sign** (ASCII code decimal 45) – **space**. If a field is optional, a space must be provided.

<i>Interface type</i>	<i>Data type</i>	<i>From</i>	<i>To</i>	<i>Comments</i>
Email	Text	AEMO	Participant	

Table 9 Agency nomination notifications email format

<i>Field name</i>		<i>Field type</i>	<i>M/O/NR</i>	<i>Description</i>
from		Text	M	Will always be populated with the AEMO as the source of the email - AEMO will always act as the confirmation email generator.
to		Text	M	Market Participant configured email address as recorded by AEMO.
subject	counterparty	ParticipantDescriptor	M	Recipient Market Participant id for Injecting Market Participant, and Injecting Market Participant id for recipient.
	nomination_id	AgencyNomActivityDescriptor	M	Nomination identifier generated by AEMO.
	activity	AgencyNomActivityDescriptor	M	Agency nomination activity, i.e. nominated, confirmed, etc.
	from_gas_day	DateType	M	Gas day from which the nomination is effective, or current gas day.
	to_gas_day	DateType	O	Only applicable if agency nomination has been made standing, i.e. effective for a defined period of time.

<b>Field name</b>	<b>Field type</b>	<b>M/O/NR</b>	<b>Description</b>
body	Text	M	Nominated quantity in GJ for confirmation; additional information including nominated meter.

## 2.6.4 Examples

Let's consider an example scenario in which CleanEnergy (participant identifier = 99) nominates injections by PureEnergy (participant identifier = 37). WebExchanger will generate two emails with confirmation, one to CleanEnergy as the injecting Market Participant and another to PureEnergy as the recipient Market Participant. Note, the message body will also carry the nominated injection quantity for the recipient Market Participant and nominated meter identifier.

The subject field in the email message to CleanEnergy:

```
37 - 12345 - Injection nominated - 05 Oct 2006 - -
```

The email subject field in the message to PureEnergy:

```
99 - 12345 - Injection nominated - 05 Oct 2006 - -
```

To improve the email message readability, the email subject field may contain the company name rather than the company identifier.

## 2.7 AMDQ Nomination Interface

Market Participants will have an ability to submit their AMDQ nominations via the file upload facility provided by WebExchanger. The list of injection sites for the Close Proximity Point must be incorporated in the file as specified below and can be expanded to include any new injection sites.

The nominated AMDQ quantity is used to determine the MPs injection tie-breaking rights.

Participants are able to update their nominations of AMDQ at a CPP to each SIP during the gas day providing the renominated quantities are not less than the cumulative AMDQ amount deemed to have been used over the previous scheduling intervals.

### 2.7.1 File format

<i>Interface type</i>	<i>Data type</i>	<i>From</i>	<i>To</i>	<i>Comments</i>
File	CSV	Participant	AEMO	

File header fields are to be set as per following table:

<i>Field name</i>	<i>Field type</i>	<i>M/O/NR</i>	<i>Field value / example</i>
file_type	FileTypeDescriptor	M	AMD
market_participant	ParticipantDescriptor	M	99
commencement_date	DateType	O	

<i>Field name</i>	<i>Field type</i>	<i>M/O/NR</i>	<i>Field value / example</i>
termination_date	DateType	O	
Close Proximity Point	CPPDescriptor	M	CPP Description e.g. Longford. Iona, Culcairn, Bass Gas

**Table 10 AMDQ Nomination Fields**

<i>Field name</i>	<i>Field type</i>	<i>M/O/NR</i>	<i>Field value / example</i>
Meter Description	MeterDescriptor	M	Meter Description e.g. 30000001PC
AMDQ Nomination	QuantityRelType	M	Nomination percentage to apply to this meter.
Repeat this entry for every Injection Meter at the Close Proximity point.			

The following format validations rules will be applied to the uploaded file:

- All mandatory fields are provided.
- The supplied fields are of valid data format (e.g. numeric fields do not contain letters)

The uploaded file is NOT validated for the following rules:

- The CPP contained in the file header is a valid CPP.
- The meters listed in the AMDQ nomination fields are applicable to the CPP.
- The value of the AMDQ nomination percentages are valid.

This validation only occurs once the AMDQ Nomination is submitted,

## 2.7.2 Examples

AMDQ Nomination by CleanEnergy (participant identifier = 99) for a specific gas day.

```
AMD,99,12 May 2010,,Longford,
30000001PC, 80%,
30000167PC, 20%,
```

Standing AMDQ Nomination by CleanEnergy:

```
AMD, 99, 12 May 2010, 15 Jun 2010, Iona,  
  
30000154PC, 50%,  
30000168PC, 20%,  
30000181PC, 10%,  
30000197PC, 10%,
```

Note:

The percentage symbol and decimal are optional. Webexchanger interprets the number as a percentage.

For a list of Close Proximity Points and Meter Description values please see the document “WebExchanger - Defined Data Lists” which can be found in the Documents folder in the Public Area of the MIBB (refer Related Documents table).

## 3 Markets Portal web interface

### 3.1 Overview

Market Participants are required to provide information that is used as input to the AEMO gas scheduling process. Market Participants use the DWGM section of the Markets Portal to:

- bid in the Capacity Certificates Auctions to obtain entry and exit capacity certificates for tie-breaking rights; and
- transfer all or part of their capacity certificates to another Market Participant.

Apart from manual entry in Markets Portal, Market Participants can also upload a CSV file to submit their bids. Market Participants can download the CSV file once they have entered their values for reference or to use it in the future to upload the details directly.

With the release of the Capacity Certificate Auction functionality in the Markets Portal, participants can submit auction bids only using the Markets Portal web interface or populate the screen from a CSV file uploaded via the Markets Portal web interface.

*NOTE: The Markets Portal User Guide is integrated within the Portal. The Markets Portal is a separate interface to the Webexchanger.*

### 3.2 User rights access

The user rights access used to access the DWGM interfaces is:

- DWGM\_CC\_AUCTION\_BIDDING – DWGM Capacity Certificate Auction Bidding.

Participant Administrators (PAs) authorise Participant User access in MSATS. The initial PA is set up by the AEMO system administrator as part of the registration process.

Your company's participant administrator (PA) grants you permission to use the DWGM interface.

*NOTE: For details about participant administration and user rights access, see User Rights Management in the Markets Portal User Guide.*

### 3.3 DWGM Capacity Certificate auction process

The DWGM process consists of the following process:

- CC auction and bidding process
- CC transfer process

### 3.4 Accessing DWGM Capacity Certificate Functionality

In the Markets Portal, there is a menu item for the DWGM with two submenus - Capacity Certificate Auction screen; and Capacity Certificate (CC) Transfer screen (see below).



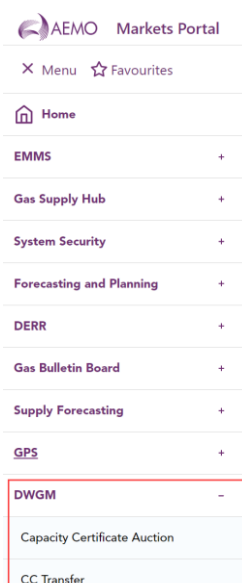

Figure 7 Markets Portal &gt; DWGM &gt; submenus

## 3.5 CC auction and bidding process

### 3.5.1 CC auction: pre-auction process

AEMO sends out an auction notice with an auction date and the auction window.

With the auction notice, the supporting reports are also made available to the Market Participants as MIBB reports and on the Markets Portal.

AEMO opens an auction bidding period which allows participants to use the Capacity Certificate Auction screen to submit their bids.

### 3.5.2 CC auction: bidding process

Once the auction notice is sent to the participants, the Capacity Certificate Auction screen is available to the participants on the Markets Portal

*NOTE: The Market Participant's status as a valid participant is checked at every stage during the auction window. If at any stage, the participant's status changes to suspended or deregistered, the bids are rejected, and the participant will not be able to continue participating in the CC Auction.*

The Market Participant logs in to the Markets Portal to access the Capacity Certificate Auction screen under the DWGM menu item.

In the Capacity Certificate Auction screen, the Market Participant enters the values for Zone, range of months (i.e. 36-month period), quantity and price for the bids, and submits the bids to AEMO.

Each submission via the Capacity Certificate Auction screen, is linked to a specific auction and represents the bids for that auction from that participant. A new submission from that participant, replaces the existing bids with new bids.

### 3.5.3 CC auction: post-auction process

Once the CC auction has been approved, the auction quantities are registered to the Market Participant and MIBB reports are published.

### 3.6 CC auction: transfer process

The CC Transfer screen is available to participants who want to transfer some or all their quantities to another participant for defined periods (i.e. monthly period(s)) for the capacity certificate.

Using the CC Transfer screen, the Market Participant can choose to transfer some of their capacity certificate quantity for the month to another Market Participant. The recipient Market Participant must accept the capacity certificate quantity transfer. The recipient will be able to view the incoming transfer via the CC Transfer screen.

Once the Market Participant has submitted a request to transfer their capacity certificate quantity, it cannot be allocated in another transfer concurrently (i.e. MP A has 100 GJ CC. MP A transfers 75 GJ to MP B. MP A can only transfer the remaining 25 GJ CC to MP C for that period).

The Market Participant accepting the transfer must do so by the end of the same calendar day. If they do not, the transfer process is expired and the capacity certificates are returned to the Market Participant.

### 3.7 CSV file data requirements

Market Participants can use a CSV file to populate the Capacity Certificate Auction screen. Market Participants can use the:

- Download CSV; and
- Upload CSV.

*Note: There is no file submission to replace the operation of the Capacity Certificate Auction screen. This screen may be populated by CSV Upload. All auction bids are still submitted via the Capacity Certificate Auction screen.*

#### 3.7.1 Operation of the Download CSV

The Download CSV button can be used by Market Participants, after populating the Capacity Certificate Auction screen, to download data used to populate the Capacity Certificate Auction screen as a CSV file.

The downloaded CSV file can be used on the Capacity Certificate Auction screen, via the CSV upload functionality, to populate the screen for a future bidding period.

When pressing the Download CSV button, the Market Participant is prompted for a location to save the files.

#### 3.7.2 Operation of the Upload CSV

The Uploaded CSV button is used to populate the fields in the Capacity Certificate Auction screen. Market Participants must then submit their bids manually after uploading the CSV file.

When pressing the Upload CSV button a new pop-up window displays requesting the User to upload two CSV files, a product file and steps file. The User clicks the Select file button to upload the product and price steps files respectively.

Sample data is a bid products CSV file:

1	Bid ID, Zone, Linked, From Month, To Month
2	1, South West Entry, Yes, May-2022, Jul-2022
3	1, South West Exit, Yes, May-2022, Jul-2022
4	2, Northern Entry, Yes, Aug-2022, Oct-2022
5	2, Northern Exit, Yes, Aug-2022, Oct-2022

Sample data in a bid price steps CSV file:

1	Bid ID, Cumulative Quantity, Step Price
2	1, 100000, 0.0004
3	1, 200000, 0.0002
4	1, 300000, 0.0001
5	2, 100000, 0.0004
6	2, 200000, 0.0003

## 4 MIBB Reports

### 4.1 Overview

AEMO, communicates with Registered Participants, through the Market Information Bulletin Board (MIBB). This communication is in two forms:

- AEMO generated reports for Registered Participants; and
- Registered Participants CSV file upload to AEMO.

### 4.2 CSV Reports

AEMO will generate numerous reports and will make them available to Market Participants via the Market Information Bulletin Board (MIBB). MIBB controls access rights to reports via two categories of users:

- Registered users. Relevant reports will be made available to organisations registered with AEMO. AEMO will provide a user id and a password to access the registered user's area of MIBB.
- Participant confidential. Only the nominated Market Participant can view these reports.

There are two report types that are provided via MIBB:

- CSV reports. Most reports in the system are created as CSV reports. These reports can be downloaded from MIBB, and then later used to facilitate data analysis using Microsoft® Excel™ spreadsheets, or other tools.
- HTML reports. These reports will be generated using HTML format, and can be viewed via Internet browsers like Microsoft® Internet Explorer™. Most likely, HTML reports will be used as index pages to CSV reports.

As the list of reports and their contents is currently being discussed and finalised by the appropriate working group, this document only specifies the general interface requirements.

#### 4.2.1 File naming

CSV reports names will start with the corresponding interface identifier. The file extension will be set to .csv.

#### 4.2.2 Report structure

A CSV MIBB report will be composed of:

- Report headers/column headers,
- Report body

#### 4.2.3 Report header

Column headings are to be named using lower-case characters.

Similar column names are to be used for all similar data quantities within the report, i.e. if a report has several energy columns then column headings should be named in similar manner. For example, xxx\_energy, yyy\_energy, zzz\_energy.

Date formats are as per data dictionary; refer to Section 2.2.6 of this document.

#### 4.2.4 Report body

Hourly trading intervals in the report body are to be represented by ordinal numbers, i.e. 1 through to 24, where the first value/interval refers to the gas day beginning hour, currently defined as 6am.

Gas date columns must refer to the Gas Day, not to a calendar date.

### 4.3 HTML Report Template

HTML reports will use common styling elements to ensure consistency in the presentation.

#### 4.3.1 Common header

The common header for HTML reports comprises AEMO logo, and the report title. A sample screenshot of a MIBB report is shown below.



#### 4.3.2 Report body

Individual reports will have specific display requirements. An example of a report body is shown below:

Gas Day	Market Price GST Ex	EoD Linepack Capacity Price GST Ex
02 Aug 2005 9:00AM	\$2.9830	\$0.0000 03/08/2005 12:53 pm
01 Aug 2005 9:00AM	\$2.9830	\$0.0000 03/08/2005 12:53 pm
31 Jul 2005 9:00AM	\$2.9814	\$0.0000 03/08/2005 12:53 pm
30 Jul 2005 9:00AM	\$2.9830	\$0.0000 03/08/2005 12:53 pm
29 Jul 2005 9:00AM	\$2.9814	\$0.0000 03/08/2005 12:53 pm
28 Jul 2005 9:00AM	\$2.9820	\$0.0000 03/08/2005 12:53 pm
27 Jul 2005 9:00AM	\$2.9830	\$0.0000 03/08/2005 12:53 pm
26 Jul 2005 9:00AM	\$2.9830	\$0.0000 03/08/2005 12:53 pm
25 Jul 2005 9:00AM	\$2.9820	\$0.0000 03/08/2005 12:53 pm
24 Jul 2005 9:00AM	\$2.9820	\$0.0000 03/08/2005 12:53 pm
23 Jul 2005 9:00AM	\$2.9830	\$0.0000 03/08/2005 12:53 pm
22 Jul 2005 9:00AM	\$2.9830	\$0.0000 03/08/2005 12:53 pm
21 Jul 2005 9:00AM	\$3.2950	\$0.0000 03/08/2005 12:53 pm
20 Jul 2005 9:00AM	\$3.2400	\$0.0000 03/08/2005 12:53 pm

### 4.3.3 Common footer

The common footer for a HTML report will contain the report creation timestamp. Also, provided in the common footer will be a number of hyperlinks, for example:

- A hyperlink to public MIBB area, and
- A hyperlink to WebExchanger.

A screenshot sample for the common footer is shown below:



## 4.4 CSV File Upload

Allocation/sub Allocation Agents can submit allocation data to AEMO through the Market Information Bulletin Board CSV Upload folder.

### 4.4.1 Allocation Agent Supplied File Format Requirements

The supplied filename convention should be same as defined in the specification/design for MIBB to IVI system.

<MARKET>\_<TRANSACTIONTYPE>\_<FROM\_CODE>\_<TO\_CODE>\_<YYYYMMDDHHMMSS>.CSV.

All filename values are defined as below and must be in upper case

<MARKET> VICGASW

<TRANSACTIONTYPE> ALLOCAGENTDATA

<FROM\_CODE> Who is providing the data e.g. ABCCO

<TO\_CODE> Who is receiving the data e.g. AEMO

<YYYYMMDDHHMMSS> Date/time of file creation e.g. 20100101120000.

This file should be uploaded to upload sub-folder in the Company's MIBB folder. The file should be sent in first as a .txt or .tmp and then renamed to a .CSV upon completion.

This file is supplied to AEMO with the data from MIBB report INT251/INT251a allocated to the mirns in MIBB report INT250 according to the agreed allocation method. For each hour the SUM of the allocation supplied MUST equal SUM of the individual parent MIRN energy supplied via INT251/INT251a. A failed file will NOT be reprocessed with the same name.

A new file needs to be generated each time a new INT251/INT251a is sent to the Allocation Agent.

Each time an Energy allocation file is processed an INT253 Confirmation file will be generated. Please note: several allocations processed in a short time may impact the production of the INT253 Confirmation file.

## 5 WebExchanger Web Services Automation

### 5.1 Overview

The AEMO WebExchanger web application is designed to allow participants to enter information relating to bids, demand forecasts and other relevant data to be used in the AEMO gas scheduling and settlements processes. There are two main modes of operation catered for:

- Interactive – a human user interacts with the application via a web browser to review and submit data as required. This mode allows for Comma-Separated Values (CSV) files generated in accordance with this Participant Build Pack Section 2 to be uploaded via a web browser into the WebExchanger and used to populate the screen. Note that business validation of CSV files uploaded in this fashion is not performed by WebExchanger and will be effected only upon manual submission of the populated screen.
- Automated – a machine or application interacts with the application via a standard protocol to obtain the necessary data and submit requests in an automated fashion. This interface had been requested by participants, and is implemented GMP Change Request CR002A.

This section describes the second mode of operation - automated functionality of WebExchanger with respect to the technologies used to implement the functionality, the reasoning behind the technology choices, and how participants will interact with the service.

The WebExchanger Web Services are split up into a number of discrete services relating to particular areas of functionality:

- Bid service
- Demand forecast service
- Injection hedge nomination service
- Agency injection hedge nomination service.
- AMDQ nomination service
- System service



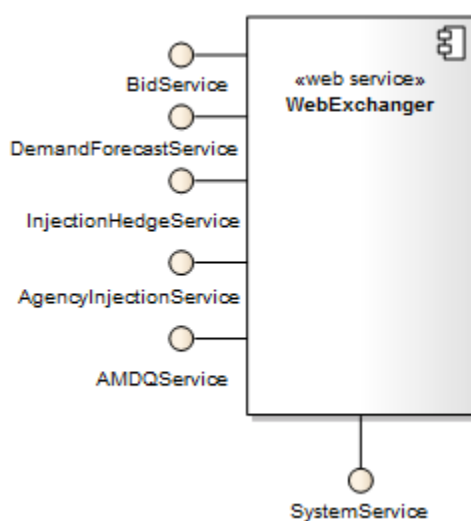

The functionality exposed through these services is documented in subsequent chapters, including detailed information relating to their input/output parameters, SOAP faults that can be thrown from the methods and other information.

## 5.2 General Requirements

### 5.2.1 Web Services, XML and SOAP

The following paragraph provides a relatively succinct definition of Web Services:

“The term Web services describes a standardized way of integrating Web-based applications using the XML, SOAP, WSDL and UDDI open standards over an Internet protocol backbone. XML is used to tag the data, SOAP is used to transfer the data, WSDL is used for describing the services available and UDDI is used for listing what services are available. Used primarily as a means for businesses to communicate with each other and with clients, Web services allow organizations to communicate data without intimate knowledge of each other’s IT systems behind the firewall.” - [http://www.webopedia.com/TERM/W/Web\\_services.html](http://www.webopedia.com/TERM/W/Web_services.html)

Essentially web services are a means of having two or more applications communicate over the Internet (or a TCP/IP network) using XML as a ‘language’ to describe the data being transferred. This approach has a number of benefits:

- It is an open, industry standard specification – although all participants will have differing I.T. environments internally, web services and SOAP ensure that the same protocols are used to exchange information, allowing different technologies to communicate without the need for proprietary protocols and technologies.
- It is available for all major platforms – being based on standards such as XML and the World Wide Web, all major technology platforms, languages and environments support web services and SOAP including Microsoft’s .Net and Sun Microsystems JEE/Java platform.

SOAP stands for the “Simple Object Access Protocol”, and provides an XML-based language to describe the data that is transferred between a web service ‘endpoint’ and a client. This standard protocol allows, for instance, a .NET application to source

and package data to send to a remote Java-based server without having to worry about the complexities of such things as byte-ordering on the two machines, or character set encoding differences.

The **SOAP 1.2** to be used in the implementation.

### 5.2.2 WebExchanger Web Services on Java Enterprise Edition (JEE)

The WebExchanger application is a JEE application and as such will always support clients built using Java technology.

The JEE platform is a mature and stable environment built on the concept of modularising and making standard all the common issues faced when developing enterprise-class applications such as clustering, load balancing, security, transactions and so on.

Given the open nature of the Java platform, there are multiple vendors that offer Web Services and SOAP libraries/toolkits that can be used to develop and/or communicate with remote Web Services, including:

- Apache Axis (Open Source)
- WASP (Commercial)

### 5.2.3 WebExchanger Web Services on .NET

The .NET platform from Microsoft is similar in many ways to the Java Enterprise Edition framework, and aims to fulfil similar goals. The .NET platform offers internal support for Web Services and provides a number of tools through the Visual Studio .NET IDE to develop and consume Web Services.

### 5.2.4 Web Services Model

There are up to four ways of structuring the way a Web Services operates and send/receives data, often referred to as the Web Service's 'style' or 'usage'. The following articles describe the message styles/formats that can be used with SOAP and notes on their pros and cons.

- <http://java.sun.com/developer/technicalArticles/xml/jaxrpcpatterns/>
- [http://msdn.microsoft.com/library/default.asp?url=/library/en-us/dnwebsrv/html/rpc\\_literal.asp](http://msdn.microsoft.com/library/default.asp?url=/library/en-us/dnwebsrv/html/rpc_literal.asp)

Essentially, there are two main styles of web services:

- RPC based – the API's exposed by the Web Services take discrete parameters and can return complex objects or simple data types. These mimic Remote Procedure Calls used in other architectures, hence the name.
- Document based – the API's exposed by the Web Services using document style simply accept an XML document as input, and return an XML document as a response. The sending and receiving systems then further process the XML documents.

The industry seems to be settling on the document style model, although there are arguably some advantages to both methods under different circumstances.

The document style from a programmer's perspective can involve more work to parse and validate the incoming XML, however this is often performed using

external tools, XML schemas and libraries and is typically not much of an additional burden.

The document style means the API's for the Web Services are more stable over time and allows for the XML schema used to describe the messages to change without having to rebuild clients because the remote API has changed (though there will often be changes in any case to support the changed schema/s). Other advantages include greater interoperability, being able to support 'less capable' clients and so on.

The WebExchanger will implement **document** / **literal** style/usage of web services.

## 5.2.5 Web Services Security and Authentication

Authentication is the process used to ensure that the person attempting to use a particular service is really who they say they are.

Throughout the I.T. industry there are many different forms of authentication in place, ranging from basic authentication in simple web applications that maintain a simple database of usernames and passwords through to technologies such as Kerberos and hardware-based encryption tokens.

WebExchanger will implement **Basic Authentication over SSL**. Basic authentication means that the user's username and password are sent in clear text to the receiving service. This has a wide range of security implications, especially over the insecure medium of the Internet, including the ability for people to 'sniff' the traffic and pickup people's credentials. For this reason, SSL is often used to encrypt the traffic being transferred to and from the Web Service.

Using SSL ensures the username and password sent over a potentially insecure medium (e.g. the Internet) remains protected through the use of strong encryption and other mechanisms.

One problem with Basic Authentication is that anyone that can obtain your username and password can essentially act as you from anywhere in the world that can access the Web Service. Although the credentials are encrypted, through other means it may still be possible for hostile attackers to obtain your username and password, such as through social engineering (e.g. pretending to be the system administrator for WebExchanger and asking for the password), dictionary-based attacks (e.g. use an exhaustive list of characters sequences or words sequentially until you gain access) and other techniques (e.g. DNS poisoning and setting up a mock WebExchanger that harvests usernames and passwords).

It is for this reason that digital certificates on the client side can be used to additionally secure the service. Digital certificates are generated and maintained at a central location and issued to clients that need to access the Web Service. In this scenario, mutual authentication takes place because the server must verify the client's certificate before allowing further access, as well as the client validating the server certificate.

The addition of using client certificate authentication introduces additional maintenance and administrative tasks on all parties involved, including the need for a central authority to manage the certificates, revocation lists and so on. Business processes will need to be put in place to properly manage the issuing of certificates, certificate expiration, stolen certificate data and so on.

## 5.2.6 WebExchanger Error Handling and SOAP Faults

WebExchanger will use the standard SOAP method for handling errors that fall outside of the normal mode of operation for the system, called SOAP 'faults'.

A SOAP fault is synonymous with the concept of an 'exception' in programming terms; that is, an exceptional condition that is not part of the standard workflow or logic for a particular operation.

The consumer of the WebExchanger Web Services can examine this reference documentation for a particular Web Service call, and obtain a list of the potential SOAP faults that can be generated.

These SOAP faults are translated on the client systems into a language-specific exception class i.e. from within a .NET development environment, the `System.Web.Services.Protocols.SoapException` exception is thrown and can be caught to perform further actions.

SOAP faults carry four important pieces of information:

- Fault message – the fault message is a human readable message that should describe the problem.
- Fault code – the fault code is the corresponding equivalent of the fault message designed for consumption by the client system. Because SOAP is used almost exclusively between two software processes, it is vital to have data that can be acted on using programmatic logic, i.e. a human readable message does not make any sense to a sending/receiving system.
- Fault details – the XML elements or other details related to the fault message and code for additional information.
- Fault actor – for a Web Service, the fault actor is typically the name of the Web Service being invoked (or its URI).

An example of a SOAP fault may be an "Access Denied" SOAP fault if a user attempts to create a bid for a meter they are not registered for. In this case, the following details may be applied to the four items of information described above:

- Fault message – for this example, the fault message might be, "Access denied when attempting to register a bid for a non-registered meter".
- Fault code – for this example, the fault code might be "3999", indicating to the client system that an access exception has occurred (which might result in an email generated to the administrator and/or other actions).
- Fault details – for this example, the fault details might include XML elements describing the meter and bid details.
- Fault actor – for this example, the fault actor might be a string such as `'/webex/services/BidServiceWS'` to indicate the Web Service generating the error.

### 5.2.7 aseXML

XML Schemas (XSD) define the structure of the messages sent to and from WebExchanger Web Services, including common data types and enumerations expressed as XML.

The document/literal contents in the WebExchanger web services will be based upon the existing **aseXML specification** that will be updated to include new transactions specifically defined for the new wholesale gas market. The new transactions will be subject to ASWG review and approval process. The WebExchanger XML Schema is a subset of the aseXML specification, and uses elements and types defined within the aseXML schema.

Note, in spite of batching capabilities incorporated into aseXML, the WebExchanger web services will carry only a single transaction and no batching is allowed.

The aseXML Schema documents are hosted by AEMO, and can be obtained at the following URL:

<https://www.aemo.com.au/energy-systems/market-it-systems/asexml-standards/asexml-schemas>

### 5.2.8 WSDL

Web Services Description Language (WSDL) is the language used to describe the interfaces exposed by a Web Services implementation.

Using a WSDL document, environments such as Eclipse (JEE) or Visual Studio (.NET) can create software to interface with the Web Services.

The WebExchanger WSDL files can be obtained from the following URLs:

- <http://<wexserver:port>/webex-ws/services/BidServiceWS?wsdl>
- <http://<wexserver:port>/webex-ws/services/DemandForecastServiceWS?wsdl>
- <http://<wexserver:port>/webex-ws/services/InjectionHedgeNominationServiceWS?wsdl>
- <http://<wexserver:port>/webex-ws/services/AgencyNominationServicesWS?wsdl>
- <http://<wexserver:port>/webex-ws/services/AMDQServiceWS?wsdl>
- <http://<wexserver:port>/webex-ws/services/SystemServiceWS?wsdl>

where *wexserver* and *port* parameters will be defined for the specific WebWExchanger configuration.

### 5.2.9 WS-I

The WebExchanger web services implementation will comply with the *WS-I Basic Profile 1.1*.

## 5.3 Fault Codes

### 5.3.1 Global Fault Codes

A SOAP fault is an error condition raised from a Web Service. SOAP faults holds information relating to the problem encountered within the generating application, including:

- A fault code
- A fault message
- A fault actor
- Any relevant fault details

The SOAP faults documented below are common to all of the WebExchanger Web Services, and represent common error conditions. These global error conditions are not documented in subsequent sections to avoid duplication.

Fault Code	Fault Description
3000	System error – this is a system error condition and indicates an internal server error that has not previously been catered for or is not handled specifically in the current codebase. Typically this will mean AEMO internal I.T. staff need to look further at the issue to handle it in a more appropriate fashion.
3001	Data not found – the record you have attempted to locate does not exist.
3002	Invalid XML – the XML request sent to the service was not valid (the document is not well-formed or does not adhere to the aseXML schema).
3003	Invalid XML for WebExchanger – the XML request sent to the service was valid according to the aseXML schema but does not meet the business requirements of the WebExchanger interface.
3100	Invalid username or password.
3101	Password expired – the currently logged in account's password has expired and needs to be reset before any other action can occur.
3102	Illegal access – the record you have attempted to locate or modify is not viewable or editable by the currently logged in account.
3103	Illegal access to MIRN – the operation you have attempted is using a MIRN that is not available to you.
3104	This error code is no longer in use. Has been superceded by 3002.
3105	Invalid commencement date or termination date supplied.
3106	This error code is no longer in use
3107	This error code is no longer in use

<b>Fault Code</b>	<b>Fault Description</b>
3108	This error code is no longer in use
3109	Invalid date supplied for a Standing submission – the commencement date must be at least one day greater than current gas day.
3110	The deadline for current gas day submissions has passed. Current Gas Day submissions cannot be made between (time) and (time).
3111	Invalid quantity value supplied. The quantity cannot be a negative value.
3112	Invalid commencement or termination date. Date must be inbetween 1-JAN-1800 and 31-DEC-9999.
3113	Invalid quantity value supplied. The quantity exceeded maximum input value.
3114	Submitted duplicate meter(s) / CPP(s) for the current market participant
3115	Submitted invalid CPP(s) for the current market participant
3116	Invalid NMI(s) supplied for the current market participant

### 5.3.2 Web Service Specific Fault Codes

Each of the Web Services listed in this document also use their own specific fault codes to indicate problems or conditions that are specific to their functionality. The table below lists the range of values allocated to each service.

<b>Fault Codes</b>	<b>Web Service</b>
3000-3499	Global Codes
3500-3599	Bid Service Codes
3600-3699	Demand Forecast Service Codes
3700-3799	Agency Nomination Service Codes
3800-3899	Injection Hedge Nomination Service Codes
3900-3999	AMDQ Nomination Service Codes



## 5.4 Web Service: Bid Service

The Bid Service is responsible for all bid-related functionality, including retrieving bid information, searching for bid information and submitting new bid information to the WebExchanger application.

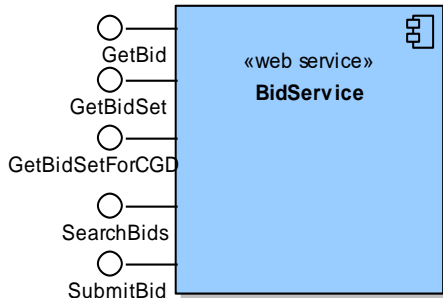

The service provides the following operations:

- GetBid
- GetBidSet
- GetBidSetForCGD
- SearchBids
- SubmitBids

### 5.4.1 GetBid

#### 5.4.1.1 Description

The `getBid()` method obtains all the data for a particular bid based on its bid identifier in the AEMO system (Bid ID), including the individual bid steps that comprise the bid stack.

Only bids submitted by the logged in user, or another user within the same company/organization, will be viewable using this method.



Request Parameter:

Simple type	BidId
-------------	-------

Request Attributes:

xsi:type	GasRetrieveRequestData
context	Bid





Response Parameter:

Complex type	GasBidType
--------------	------------

Response Attributes:

xsi:type	GasRetrieveResponseData
context	Bid

### 5.4.1.2 Input/Output Parameters

<b>Input Element</b>	GasRetrieveRequestData
<b>Input Schema</b>	<pre> &lt;xsd:complexType name="GasRetrieveRequestData"&gt;   &lt;xsd:complexContent&gt;     &lt;xsd:extension base="WholesaleRetrieveRequestData"&gt;       &lt;xsd:choice&gt;         ...         &lt;xsd:element name="BidId" type="xsd:long"/&gt;         ...       &lt;/xsd:choice&gt;       &lt;xsd:attribute         name="version" type="r30"         use="optional"         default="r30"/&gt;       &lt;xsd:attribute name="contextType"         type="GasRetrieveTransactionType" use="required"/&gt;     &lt;/xsd:extension&gt;   &lt;/xsd:complexContent&gt; &lt;/xsd:complexType&gt; </pre>

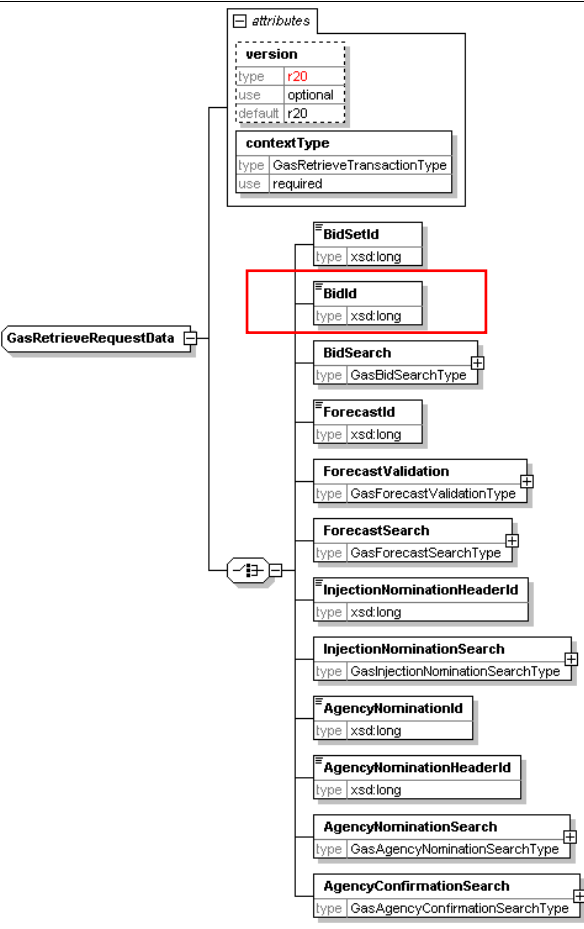
	
<p><b>Output Element</b></p>	<p>GasRetrieveResponseData</p>
<p><b>Output Schema</b></p>	<pre> &lt;xsd:complexType name="GasRetrieveResponseData"&gt;   &lt;xsd:complexContent&gt;     &lt;xsd:extension base="WholesaleRetrieveResponseData"&gt;       &lt;xsd:choice&gt;         ...         &lt;xsd:element name="Bid" type="GasBidType"/&gt;         ...       &lt;/xsd:choice&gt;       &lt;xsd:attribute name="version"         type="r31"         use="optional"         default="r31"/&gt;       &lt;xsd:attribute name="contextType"         type="GasRetrieveTransactionType"         use="required"/&gt;     &lt;/xsd:extension&gt;   &lt;/xsd:complexContent&gt; &lt;/xsd:complexType&gt;         </pre>

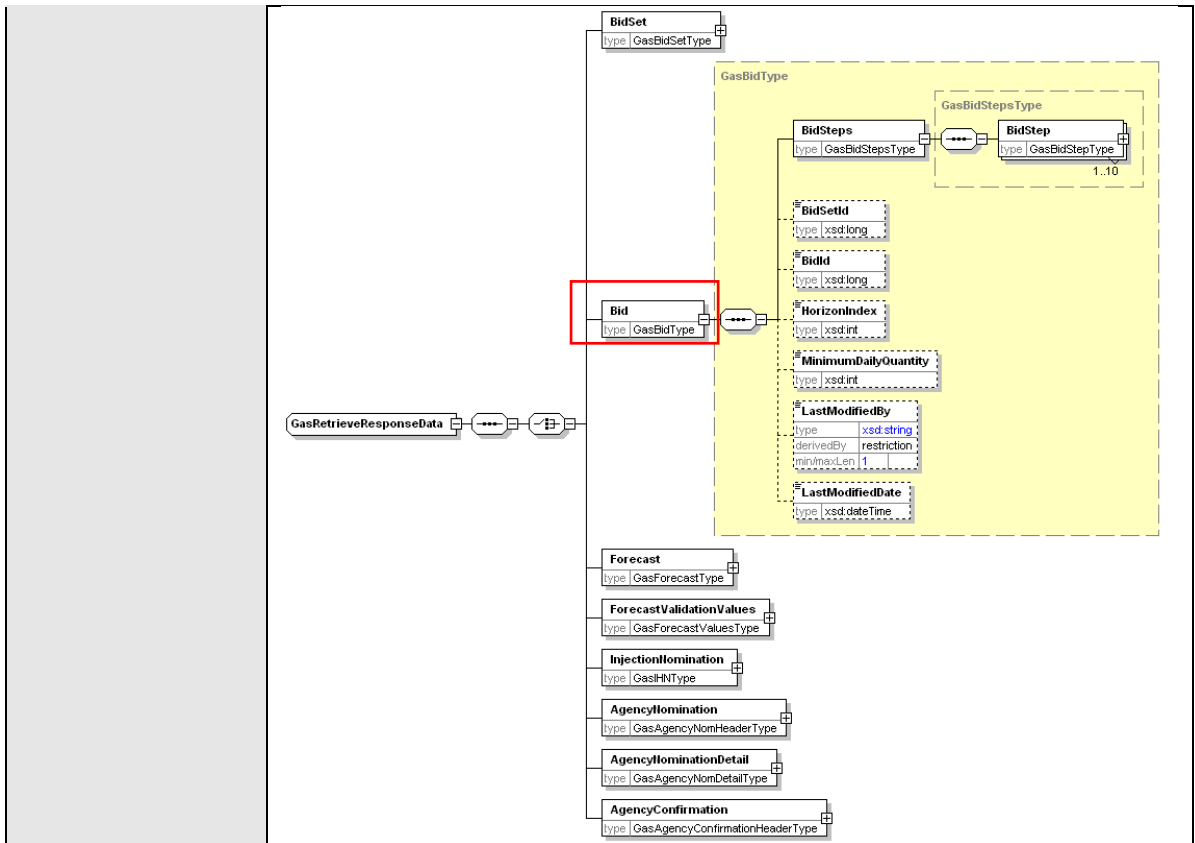

### 5.4.1.3 SOAP Faults

Fault Code	Fault Description
Global SOAP Faults	Refer to Global Fault Codes on page 61

#### 5.4.1.4 Usage example

##### Request Sample

```
<ase:aseXML xmlns:ase="urn:aseXML:r31">
  <Header>
    <From>VENCorp WebExchanger Recipient</From>
    <To>VENCorp WebExchanger</To>
    <MessageID>BBEC3F29-8FE4-12A1-B54B-7F20CF39DAB1</MessageID>
    <MessageDate>2006-03-16T13:49:10.094+10:00</MessageDate>
    <TransactionGroup>MKTW</TransactionGroup>
    <Priority>Medium</Priority>
    <Market>VICGAS</Market>
  </Header>
  <Transactions>
    <Transaction transactionID="BBEC3F29-8FE4-12A1-B54B-7F20CF39DAB1"
      transactionDate="2006-03-16T13:49:10.094+10:00">
      <WholesaleRetrieveRequest version="r20">
        <RetrieveRequestData version="r30" contextType="Bid"
          xsi:type="urn:GasRetrieveRequestData"
          xmlns:urn="urn:aseXML:r31"
          xmlns:xsi="http://www.w3.org/2001/XMLSchema-instance">
          <BidId>1</BidId>
        </RetrieveRequestData>
      </WholesaleRetrieveRequest>
    </Transaction>
  </Transactions>
</ase:aseXML>
```

##### Response Sample

```
<ase:aseXML xmlns:ase="urn:aseXML:r31">
  <Header>
    <From>VENCorp WebExchanger</From>
    <To>VENCorp WebExchanger Recipient</To>
    <MessageID>0ECC6396-FA75-C744-5799-73D4D7E557D1</MessageID>
    <MessageDate>2006-03-16T13:52:42.922+10:00</MessageDate>
    <TransactionGroup>MKTW</TransactionGroup>
    <Priority>Medium</Priority>
    <Market>VICGAS</Market>
  </Header>
  <Transactions>
    <Transaction transactionID="0ECC6396-FA75-C744-5799-73D4D7E557D1"
      transactionDate="2006-03-16T13:52:42.922+10:00">
      <WholesaleRetrieveResponse version="r20">
        <RetrieveResponseData contextType="BidSet"
          xsi:type="urn:GasRetrieveResponseData"
          xmlns:urn="urn:aseXML:r31"
          xmlns:xsi="http://www.w3.org/2001/XMLSchema-instance">
          <BidSet>
            <BidType>INJEC</BidType>
            <Period>
              <BeginDate>2006-03-15+10:00</BeginDate>
              <EndDate>2006-03-16+10:00</EndDate>
            </Period>
            <NMI>30000001PC</NMI>
            <Bids>
              <Bid>
                <BidSteps>
                  <BidStep>
                    <Step>1</Step>
                    <Price>4.01</Price>
                    <DailyQuantity>4820</DailyQuantity>
                    <BidId>1</BidId>
                    <LastModifiedBy>TEST</LastModifiedBy>
                    <LastModifiedDate>2006-03-16T10:33:01.723+10:00</LastModifiedDate>
                  </BidStep>
                </BidSteps>
              </Bid>
            </Bids>
          </RetrieveResponseData>
        </WholesaleRetrieveResponse>
      </Transaction>
    </Transactions>
  </ase:aseXML>
```

```

<BidStep>
  <Step>2</Step>
  <Price>4.02</Price>
  <DailyQuantity>4920</DailyQuantity>
  <BidId>1</BidId>
  <LastModifiedBy>TEST</LastModifiedBy>
  <LastModifiedDate>2006-03-16T10:33:01.723+10:00</LastModifiedDate>
</BidStep>
<BidStep>
  <Step>3</Step>
  <Price>4.03</Price>
  <DailyQuantity>5020</DailyQuantity>
  <BidId>1</BidId>
  <LastModifiedBy>TEST</LastModifiedBy>
  <LastModifiedDate>2006-03-16T10:33:01.723+10:00</LastModifiedDate>
</BidStep>
<BidStep>
  <Step>4</Step>
  <Price>4.04</Price>
  <DailyQuantity>5120</DailyQuantity>
  <BidId>1</BidId>
  <LastModifiedBy>TEST</LastModifiedBy>
  <LastModifiedDate>2006-03-16T10:33:01.723+10:00</LastModifiedDate>
</BidStep>
<BidStep>
  <Step>5</Step>
  <Price>4.05</Price>
  <DailyQuantity>5220</DailyQuantity>
  <BidId>1</BidId>
  <LastModifiedBy>TEST</LastModifiedBy>
  <LastModifiedDate>2006-03-16T10:33:01.723+10:00</LastModifiedDate>
</BidStep>
</BidSteps>
<BidSetId>10000</BidSetId>
<BidId>1</BidId>
<HorizonIndex>1</HorizonIndex>
<MinimumDailyQuantity>1234</MinimumDailyQuantity>
<LastModifiedBy>Wextest</LastModifiedBy>
<LastModifiedDate>2006-03-15T14:59:56.340+10:00</LastModifiedDate>
</Bid>
<Bid>
  <BidSteps>
    <BidStep>
      <Step>1</Step>
      <Price>4.01</Price>
      <DailyQuantity>4820</DailyQuantity>
      <BidId>2</BidId>
      <LastModifiedBy>TEST</LastModifiedBy>
      <LastModifiedDate>2006-03-16T10:33:01.723+10:00</LastModifiedDate>
    </BidStep>
    <BidStep>
      <Step>2</Step>
      <Price>4.02</Price>
      <DailyQuantity>4920</DailyQuantity>
      <BidId>2</BidId>
      <LastModifiedBy>TEST</LastModifiedBy>
      <LastModifiedDate>2006-03-16T10:33:01.723+10:00</LastModifiedDate>
    </BidStep>
    <BidStep>
      <Step>3</Step>
      <Price>4.03</Price>
      <DailyQuantity>5020</DailyQuantity>
      <BidId>2</BidId>
      <LastModifiedBy>TEST</LastModifiedBy>
      <LastModifiedDate>2006-03-16T10:33:01.723+10:00</LastModifiedDate>
    </BidStep>
    <BidStep>
      <Step>4</Step>
      <Price>4.04</Price>
      <DailyQuantity>5120</DailyQuantity>
      <BidId>2</BidId>
      <LastModifiedBy>TEST</LastModifiedBy>
    </BidStep>
  </BidSteps>
</Bid>

```

```

        <LastModifiedDate>2006-03-16T10:33:01.723+10:00</LastModifiedDate>
    </BidStep>
    <BidStep>
        <Step>5</Step>
        <Price>4.05</Price>
        <DailyQuantity>5440</DailyQuantity>
        <BidId>2</BidId>
        <LastModifiedBy>TEST</LastModifiedBy>
        <LastModifiedDate>2006-03-16T10:33:01.723+10:00</LastModifiedDate>
    </BidStep>
</BidSteps>
<BidSetId>10000</BidSetId>
<BidId>2</BidId>
<HorizonIndex>2</HorizonIndex>
<MinimumDailyQuantity>1234</MinimumDailyQuantity>
<LastModifiedBy>Wextest</LastModifiedBy>
<LastModifiedDate>2006-03-15T15:59:26.016+10:00</LastModifiedDate>
</Bid>
</Bids>
<BidSetId>10000</BidSetId>
<CompanyId>10000</CompanyId>
<LastModifiedBy>TEST</LastModifiedBy>
<LastModifiedDate>2006-03-15T14:59:26.096+10:00</LastModifiedDate>
</BidSet>
</RetrieveResponseData>
</WholesaleRetrieveResponse>
</Transaction>
</Transactions>
</ase:aseXML>
    
```

## 5.4.2 GetBidSet

### 5.4.2.1 Description

The `getBidSet()` method obtains all the data for a particular bid set based on its bid set identifier in the AEMO system (Bid Set ID). A bid set is a collection of bids which can span multiple days (a standing bid) or represent a single day's set of bids for one or more scheduling horizons.

Only bid sets submitted by the logged in user, or another user within the same company/organization, will be viewable using this method.



Request Parameter:

Simple type	BidSetId
-------------	----------

Request Attributes:

xsi:type	GasRetrieveRequestData
context	BidSet



Response Parameter:

Complex type	GasBidSetType
--------------	---------------

Response Attributes:

xsi:type	GasRetrieveResponseData
context	BidSet

### 5.4.2.2 Input/Output Parameters

<b>Input Element</b>	GasRetrieveRequestData
<b>Input Schema</b>	<pre> &lt;xsd:complexType name="GasRetrieveRequestData"&gt;   &lt;xsd:complexContent&gt;     &lt;xsd:extension base="WholesaleRetrieveRequestData"&gt;       &lt;xsd:choice&gt;         ...         &lt;xsd:element name="BidSetId" type="xsd:long"/&gt;         ...       &lt;/xsd:choice&gt;       &lt;xsd:attribute         name="version" type="r30" use="optional" default="r30"/&gt;       &lt;xsd:attribute name="contextType"         type="GasRetrieveTransactionType" use="required"/&gt;     &lt;/xsd:extension&gt;   &lt;/xsd:complexContent&gt; &lt;/xsd:complexType&gt; </pre>

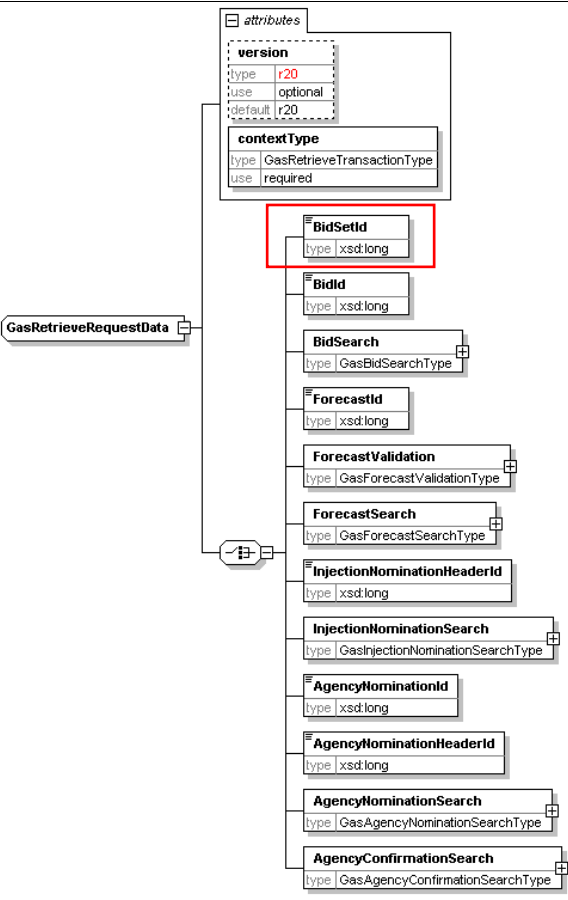
	
<p><b>Output Element</b></p>	<p>GasRetrieveResponseData</p>
<p><b>Output Schema</b></p>	<pre> &lt;xsd:complexType name="GasRetrieveResponseData"&gt;   &lt;xsd:complexContent&gt;     &lt;xsd:extension base="WholesaleRetrieveResponseData"&gt;       &lt;xsd:choice&gt;         ...         &lt;xsd:element name="BidSet" type="GasBidSetType"/&gt;         ...       &lt;/xsd:choice&gt;       &lt;xsd:attribute         name="version"         type="r31"         use="optional"         default="r31"/&gt;       &lt;xsd:attribute name="contextType"         type="GasRetrieveTransactionType" use="required"/&gt;     &lt;/xsd:extension&gt;   &lt;/xsd:complexContent&gt; &lt;/xsd:complexType&gt;     </pre>



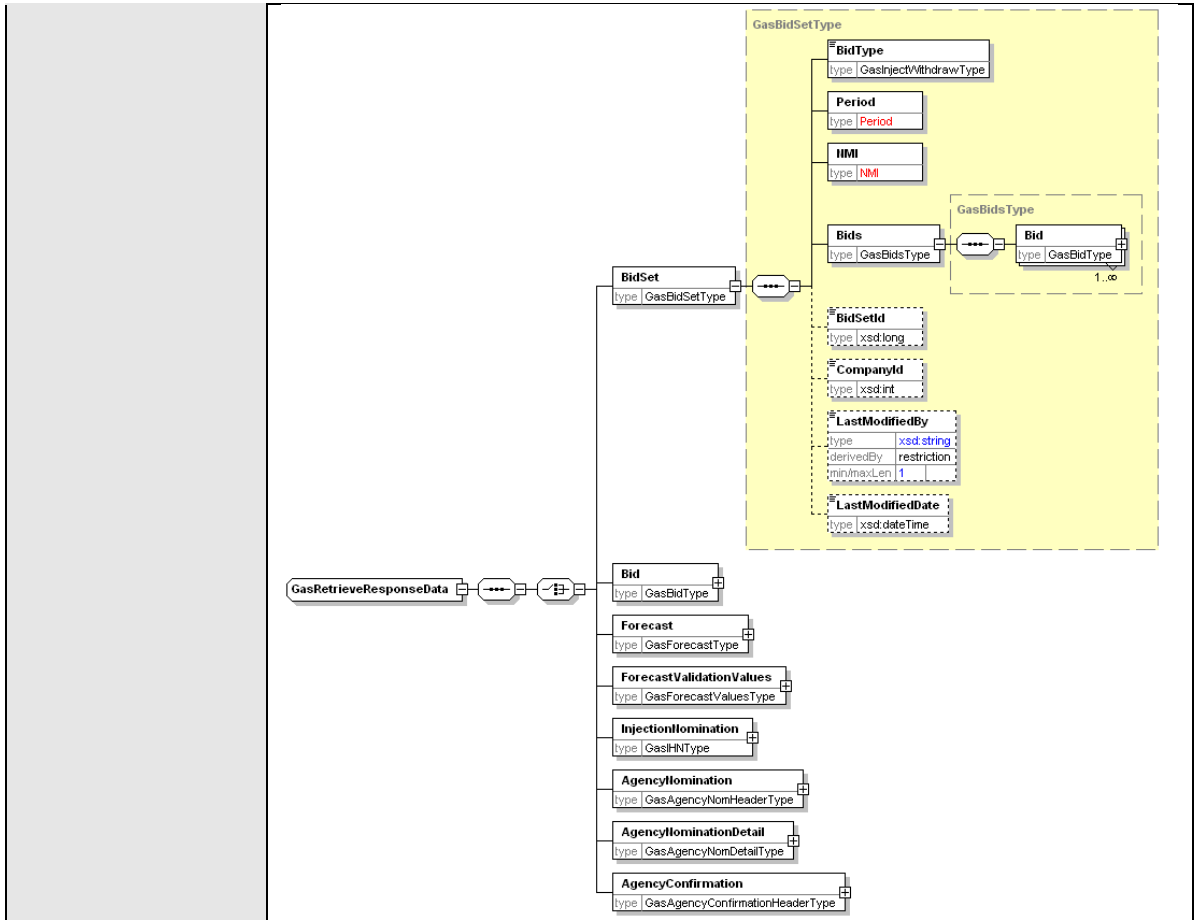

5.4.2.3 SOAP Faults

Fault Code	Fault Description
Global SOAP Faults	Refer to Global Fault Codes on page 61

#### 5.4.2.4 Usage example

##### Request Sample

```

<ase:aseXML xmlns:ase="urn:aseXML:r31">
  <Header>
    <From>VENCorp WebExchanger Recipient</From>
    <To>VENCorp WebExchanger</To>
    <MessageID>F6103DF9-FEF5-3DBE-8030-EBE02D710CF7</MessageID>
    <MessageDate>2006-03-16T13:52:40.796+10:00</MessageDate>
    <TransactionGroup>MKTW</TransactionGroup>
    <Priority>Medium</Priority>
    <Market>VICGAS</Market>
  </Header>
  <Transactions>
    <Transaction transactionID="F6103DF9-FEF5-3DBE-8030-EBE02D710CF7"
      transactionDate="2006-03-16T13:52:40.796+10:00">
      <WholesaleRetrieveRequest version="r20">
        <RetrieveRequestData version="r30" contextType="BidSet"
          xsi:type="urn:GasRetrieveRequestData"
          xmlns:urn="urn:aseXML:r31"
          xmlns:xsi="http://www.w3.org/2001/XMLSchema-instance">
          <BidSetId>10000</BidSetId>
        </RetrieveRequestData>
      </WholesaleRetrieveRequest>
    </Transaction>
  </Transactions>
</ase:aseXML>

```

## Response Sample

```

<ase:aseXML xmlns:ase="urn:aseXML:r31">
  <Header>
    <From>VENCorp WebExchanger</From>
    <To>VENCorp WebExchanger Recipient</To>
    <MessageID>0ECC6396-FA75-C744-5799-73D4D7E557D1</MessageID>
    <MessageDate>2006-03-16T13:52:42.922+10:00</MessageDate>
    <TransactionGroup>MKTW</TransactionGroup>
    <Priority>Medium</Priority>
    <Market>VICGAS</Market>
  </Header>
  <Transactions>
    <Transaction transactionID="0ECC6396-FA75-C744-5799-73D4D7E557D1"
      transactionDate="2006-03-16T13:52:42.922+10:00">
      <WholesaleRetrieveResponse version="r20">
        <RetrieveResponseData
          contextType="BidSet"
          xsi:type="urn:GasRetrieveResponseData"
          xmlns:urn="urn:aseXML:r31"
          xmlns:xsi="http://www.w3.org/2001/XMLSchema-instance">
          <BidSet>
            <BidType>INJEC</BidType>
            <Period>
              <BeginDate>2006-03-15+10:00</BeginDate>
              <EndDate>2006-03-16+10:00</EndDate>
            </Period>
            <NMI>30000001PC</NMI>
            <Bids>
              <Bid>
                <BidSteps>
                  <BidStep>
                    <Step>1</Step>
                    <Price>4.01</Price>
                    <DailyQuantity>4820</DailyQuantity>
                    <BidId>1</BidId>
                    <LastModifiedBy>TEST</LastModifiedBy>
                    <LastModifiedDate>2006-03-16T10:33:01.723+10:00</LastModifiedDate>
                  </BidStep>
                  <BidStep>
                    <Step>2</Step>
                    <Price>4.02</Price>
                    <DailyQuantity>4920</DailyQuantity>
                    <BidId>1</BidId>
                    <LastModifiedBy>TEST</LastModifiedBy>
                    <LastModifiedDate>2006-03-16T10:33:01.723+10:00</LastModifiedDate>
                  </BidStep>
                  <BidStep>
                    <Step>3</Step>
                    <Price>4.03</Price>
                    <DailyQuantity>5020</DailyQuantity>
                    <BidId>1</BidId>
                    <LastModifiedBy>TEST</LastModifiedBy>
                    <LastModifiedDate>2006-03-16T10:33:01.723+10:00</LastModifiedDate>
                  </BidStep>
                  <BidStep>
                    <Step>4</Step>
                    <Price>4.04</Price>
                    <DailyQuantity>5120</DailyQuantity>
                    <BidId>1</BidId>
                    <LastModifiedBy>TEST</LastModifiedBy>
                    <LastModifiedDate>2006-03-16T10:33:01.723+10:00</LastModifiedDate>
                  </BidStep>
                  <BidStep>
                    <Step>5</Step>
                    <Price>4.05</Price>
                    <DailyQuantity>5220</DailyQuantity>
                    <BidId>1</BidId>
                    <LastModifiedBy>TEST</LastModifiedBy>
                    <LastModifiedDate>2006-03-16T10:33:01.723+10:00</LastModifiedDate>
                  </BidStep>
                </BidSteps>
              </Bid>
            </Bids>
          </RetrieveResponseData>
        </WholesaleRetrieveResponse>
      </Transaction>
    </Transactions>
  </ase:aseXML>

```

```

        </BidStep>
    </BidSteps>
    <BidSetId>10000</BidSetId>
    <BidId>1</BidId>
    <HorizonIndex>1</HorizonIndex>
    <MinimumDailyQuantity>1234</MinimumDailyQuantity>
    <LastModifiedBy>Wextest</LastModifiedBy>
    <LastModifiedDate>2006-03-15T14:59:56.340+10:00</LastModifiedDate>
</Bid>
<Bid>
    <BidSteps>
        <BidStep>
            <Step>1</Step>
            <Price>4.01</Price>
            <DailyQuantity>4820</DailyQuantity>
            <BidId>2</BidId>
            <LastModifiedBy>TEST</LastModifiedBy>
            <LastModifiedDate>2006-03-16T10:33:01.723+10:00</LastModifiedDate>
        </BidStep>
        <BidStep>
            <Step>2</Step>
            <Price>4.02</Price>
            <DailyQuantity>4920</DailyQuantity>
            <BidId>2</BidId>
            <LastModifiedBy>TEST</LastModifiedBy>
            <LastModifiedDate>2006-03-16T10:33:01.723+10:00</LastModifiedDate>
        </BidStep>
        <BidStep>
            <Step>3</Step>
            <Price>4.03</Price>
            <DailyQuantity>5020</DailyQuantity>
            <BidId>2</BidId>
            <LastModifiedBy>TEST</LastModifiedBy>
            <LastModifiedDate>2006-03-16T10:33:01.723+10:00</LastModifiedDate>
        </BidStep>
        <BidStep>
            <Step>4</Step>
            <Price>4.04</Price>
            <DailyQuantity>5120</DailyQuantity>
            <BidId>2</BidId>
            <LastModifiedBy>TEST</LastModifiedBy>
            <LastModifiedDate>2006-03-16T10:33:01.723+10:00</LastModifiedDate>
        </BidStep>
        <BidStep>
            <Step>5</Step>
            <Price>4.05</Price>
            <DailyQuantity>5440</DailyQuantity>
            <BidId>2</BidId>
            <LastModifiedBy>TEST</LastModifiedBy>
            <LastModifiedDate>2006-03-16T10:33:01.723+10:00</LastModifiedDate>
        </BidStep>
    </BidSteps>
    <BidSetId>10000</BidSetId>
    <BidId>2</BidId>
    <HorizonIndex>2</HorizonIndex>
    <MinimumDailyQuantity>1234</MinimumDailyQuantity>
    <LastModifiedBy>Wextest</LastModifiedBy>
    <LastModifiedDate>2006-03-15T15:59:26.016+10:00</LastModifiedDate>
</Bid>
</Bids>
<BidSetId>10000</BidSetId>
<CompanyId>10000</CompanyId>
<LastModifiedBy>TEST</LastModifiedBy>
<LastModifiedDate>2006-03-15T14:59:26.096+10:00</LastModifiedDate>
</BidSet>
</RetrieveResponseData>
</WholesaleRetrieveResponse>
</Transaction>
</Transactions>
</ase:aseXML>
    
```



### 5.4.3 GetBidSetForCGD

#### 5.4.3.1 Description

The `getBidSetForCGD()` method obtains all the data for the latest bid set for the current gas day. This is a convenience method as the same data can be obtained via the related `getBid()` or `searchBids()` calls.

Only bid sets submitted by the logged in user, or another user within the same company/organization, will be viewable using this method.

Note, values that are provided in the `Period` element in the request will be ignored.



Request Parameter:

Complex type	GasBidSearchType
--------------	------------------

Request Attributes:

xsi:type	GasRetrieveRequestData
context	BidSetCGD



Response Parameter:

Complex type	GasBidSetType
--------------	---------------

Response Attributes:

xsi:type	GasRetrieveResponseData
context	BidSetCGD

#### 5.4.3.2 Input/Output Parameters

<b>Input Element</b>	GasRetrieveRequestData
<b>Input Schema</b>	<pre> &lt;xsd:complexType name="GasRetrieveRequestData"&gt;   &lt;xsd:complexContent&gt;     &lt;xsd:extension base="WholesaleRetrieveRequestData"&gt;       &lt;xsd:choice&gt;         ...         &lt;xsd:element name="BidSearch" type="GasBidSearchType"/&gt;         ...       &lt;/xsd:choice&gt;       &lt;xsd:attribute name="version"         type="r30"         use="optional"         default="r30"/&gt;     </pre>

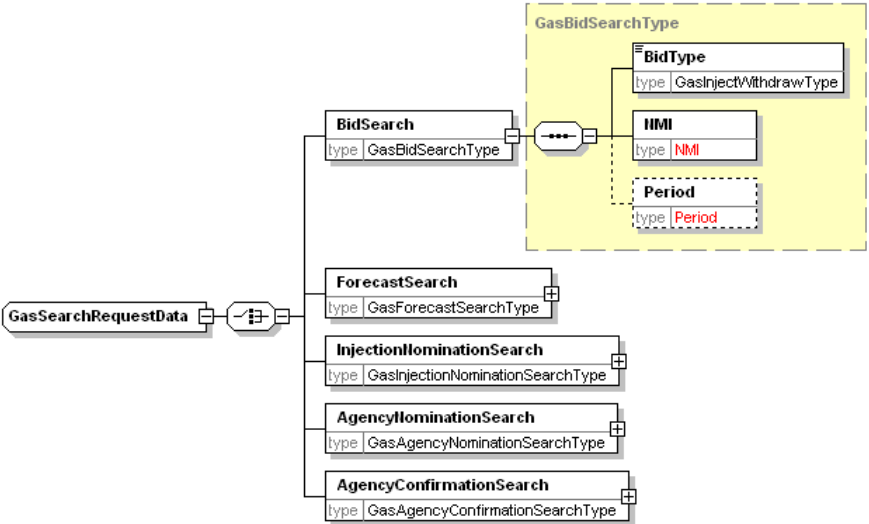
	<pre> &lt;xsd:attribute name="contextType"   type="GasRetrieveTransactionType" use="required"/&gt; &lt;/xsd:extension&gt; &lt;/xsd:complexContent&gt; &lt;/xsd:complexType&gt;         </pre> 
<b>Output Element</b>	GasRetrieveResponseData
<b>Output Schema</b>	<pre> &lt;xsd:complexType name="GasRetrieveResponseData"&gt;   &lt;xsd:complexContent&gt;     &lt;xsd:extension base="WholesaleRetrieveResponseData"&gt;       &lt;xsd:choice&gt;         ...         &lt;xsd:element name="BidSet" type="GasBidSetType"/&gt;         ...       &lt;/xsd:choice&gt;       &lt;xsd:attribute         name="version" type="r31" use="optional" default="r31"/&gt;       &lt;xsd:attribute name="contextType"         type="GasRetrieveTransactionType" use="required"/&gt;     &lt;/xsd:extension&gt;   &lt;/xsd:complexContent&gt; &lt;/xsd:complexType&gt;         </pre>

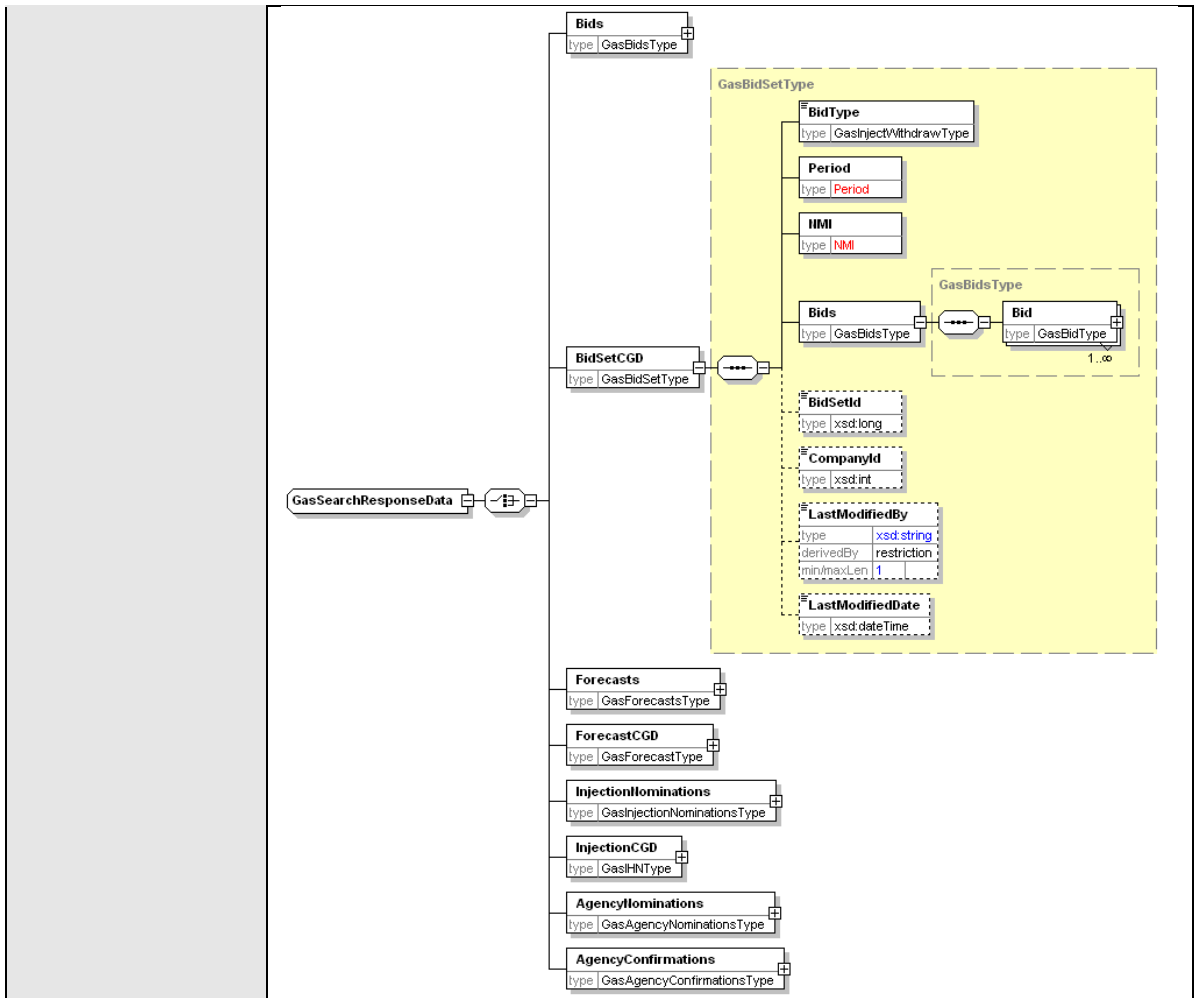

### 5.4.3.3 SOAP Faults

Fault Code	Fault Description
Global SOAP Faults	Refer to Global Fault Codes on page 61



### 5.4.3.4 Usage example

#### Request Sample

```
<ase:aseXML xmlns:ase="urn:aseXML:r31">
  <Header>
    <From>VENCorp WebExchanger Recipient</From>
    <To>VENCorp WebExchanger</To>
    <MessageID>4E703132-F2DC-9B9B-A1DC-CA62F4B5B675</MessageID>
    <MessageDate>2006-03-16T15:07:01.923+10:00</MessageDate>
    <TransactionGroup>MKTW</TransactionGroup>
    <Priority>Medium</Priority>
    <Market>VICGAS</Market>
  </Header>
  <Transactions>
    <Transaction transactionID="4E703132-F2DC-9B9B-A1DC-CA62F4B5B675"
      transactionDate="2006-03-16T15:07:01.923+10:00">
      <WholesaleRetrieveRequest version="r20">
        <RetrieveRequestData version="r30" contextType="BidSetCGD"
          xsi:type="urn:GasRetrieveRequestData"
          xmlns:urn="urn:aseXML:r31"
          xmlns:xsi="http://www.w3.org/2001/XMLSchema-instance">
          <BidSearch>
            <BidType>INJEC</BidType>
            <NMI>30000001PC</NMI>
          </BidSearch>
        </RetrieveRequestData>
      </WholesaleRetrieveRequest>
    </Transaction>
  </Transactions>
</ase:aseXML>
```

#### Response Sample

```
<ase:aseXML xmlns:ase="urn:aseXML:r31">
  <Header>
    <From>VENCorp WebExchanger</From>
    <To>VENCorp WebExchanger Recipient</To>
    <MessageID>0ECC6396-FA75-C744-5799-73D4D7E557D1</MessageID>
    <MessageDate>2006-03-16T13:52:42.922+10:00</MessageDate>
    <TransactionGroup>MKTW</TransactionGroup>
    <Priority>Medium</Priority>
    <Market>VICGAS</Market>
  </Header>
  <Transactions>
    <Transaction transactionID="0ECC6396-FA75-C744-5799-73D4D7E557D1"
      transactionDate="2006-03-16T13:52:42.922+10:00">
      <WholesaleRetrieveResponse version="r20">
        <RetrieveResponseData
          contextType="BidSet"
          xsi:type="urn:GasRetrieveResponseData"
          xmlns:urn="urn:aseXML:r31"
          xmlns:xsi="http://www.w3.org/2001/XMLSchema-instance">
          <BidSet>
            <BidType>INJEC</BidType>
            <Period>
              <BeginDate>2006-03-15+10:00</BeginDate>
              <EndDate>2006-03-16+10:00</EndDate>
            </Period>
            <NMI>30000001PC</NMI>
            <Bids>
              <Bid>
                <BidSteps>
                  <BidStep>
                    <Step>1</Step>
                    <Price>4.01</Price>
                    <DailyQuantity>4820</DailyQuantity>
                  </BidStep>
                </BidSteps>
              </Bid>
            </Bids>
          </BidSet>
        </RetrieveResponseData>
      </WholesaleRetrieveResponse>
    </Transaction>
  </Transactions>
</ase:aseXML>
```

```

        <BidId>1</BidId>
        <LastModifiedBy>TEST</LastModifiedBy>
        <LastModifiedDate>2006-03-16T10:33:01.723+10:00</LastModifiedDate>
    </BidStep>
    <BidStep>
        <Step>2</Step>
        <Price>4.02</Price>
        <DailyQuantity>4920</DailyQuantity>
        <BidId>1</BidId>
        <LastModifiedBy>TEST</LastModifiedBy>
        <LastModifiedDate>2006-03-16T10:33:01.723+10:00</LastModifiedDate>
    </BidStep>
    <BidStep>
        <Step>3</Step>
        <Price>4.03</Price>
        <DailyQuantity>5020</DailyQuantity>
        <BidId>1</BidId>
        <LastModifiedBy>TEST</LastModifiedBy>
        <LastModifiedDate>2006-03-16T10:33:01.723+10:00</LastModifiedDate>
    </BidStep>
    <BidStep>
        <Step>4</Step>
        <Price>4.04</Price>
        <DailyQuantity>5120</DailyQuantity>
        <BidId>1</BidId>
        <LastModifiedBy>TEST</LastModifiedBy>
        <LastModifiedDate>2006-03-16T10:33:01.723+10:00</LastModifiedDate>
    </BidStep>
    <BidStep>
        <Step>5</Step>
        <Price>4.05</Price>
        <DailyQuantity>5220</DailyQuantity>
        <BidId>1</BidId>
        <LastModifiedBy>TEST</LastModifiedBy>
        <LastModifiedDate>2006-03-16T10:33:01.723+10:00</LastModifiedDate>
    </BidStep>
</BidSteps>
<BidSetId>10000</BidSetId>
<BidId>1</BidId>
<HorizonIndex>1</HorizonIndex>
<MinimumDailyQuantity>1234</MinimumDailyQuantity>
<LastModifiedBy>Wextest</LastModifiedBy>
<LastModifiedDate>2006-03-15T14:59:56.340+10:00</LastModifiedDate>
</Bid>
</Bids>
<BidSetId>10000</BidSetId>
<CompanyId>10000</CompanyId>
<LastModifiedBy>TEST</LastModifiedBy>
<LastModifiedDate>2006-03-15T14:59:26.096+10:00</LastModifiedDate>
</BidSet>
</RetrieveResponseData>
</WholesaleRetrieveResponse>
</Transaction>
</Transactions>
</ase:aseXML>
    
```

## 5.4.4 SearchBids

### 5.4.4.1 Description

The `searchBids()` method searches for bid information matching the criteria specified in the request message. The search can be based on:

- Start and end date
- MIRN
- Bid Type (Injection/Withdrawal)

The response message will contain zero or more matching bids.

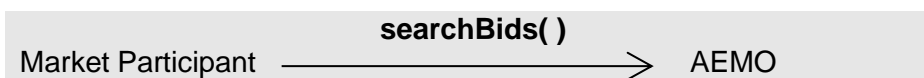

Request Parameter:

Complex type	GasBidSearchType
--------------	------------------

Request Attributes:

xsi:type	GasSearchRequestData
context	Bid



Response Parameter:

Complex type	GasBidsType
--------------	-------------

Response Attributes:

xsi:type	GasSearchResponseData
context	Bid

### 5.4.4.2 Input/Output Parameters

<b>Input Element</b>	GasSearchRequestData
<b>Input Schema</b>	<pre> &lt;xsd:complexType name="GasSearchRequestData"&gt;   &lt;xsd:complexContent&gt;     &lt;xsd:extension base="WholesaleSearchRequestData"&gt;       &lt;xsd:choice&gt;         ...         &lt;xsd:element name="BidSearch" type="GasBidSearchType"/&gt;         ...       &lt;/xsd:choice&gt;       &lt;xsd:attribute name="version"         type="r30"         use="optional"         default="r30"/&gt;     </pre>

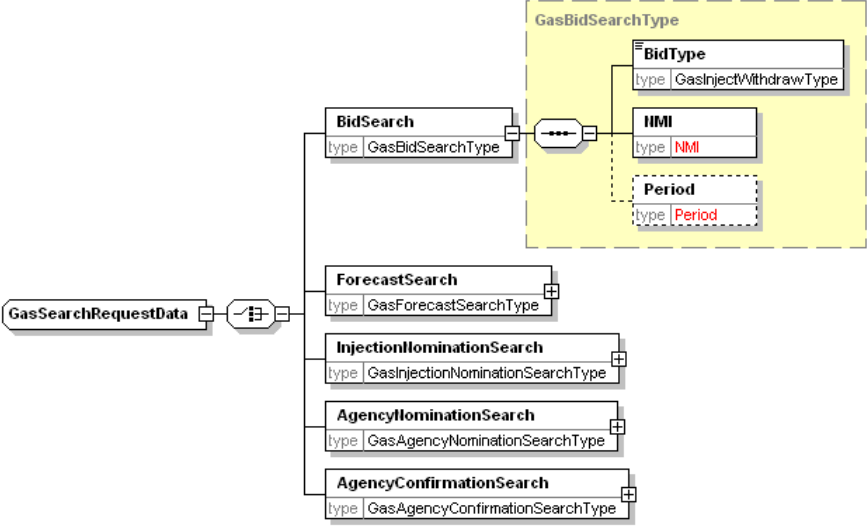
	<pre> &lt;xsd:attribute name="contextType"   type="GasSearchTransactionType"   use="required"/&gt; &lt;/xsd:extension&gt; &lt;/xsd:complexContent&gt; &lt;/xsd:complexType&gt;         </pre>
	
<b>Output Element</b>	GasSearchResponseData
<b>Output Schema</b>	<pre> &lt;xsd:complexType name="GasSearchResponseData"&gt;   &lt;xsd:complexContent&gt;     &lt;xsd:extension base="WholesaleSearchResponseData"&gt;       &lt;xsd:choice&gt;         ...         &lt;xsd:element name="Bids" type="GasBidsType"/&gt;         ...       &lt;/xsd:choice&gt;       &lt;xsd:attribute         name="version" type="r31" use="optional" default="r31"/&gt;       &lt;xsd:attribute name="contextType"         type="GasSearchTransactionType" use="required"/&gt;     &lt;/xsd:extension&gt;   &lt;/xsd:complexContent&gt; &lt;/xsd:complexType&gt;         </pre>

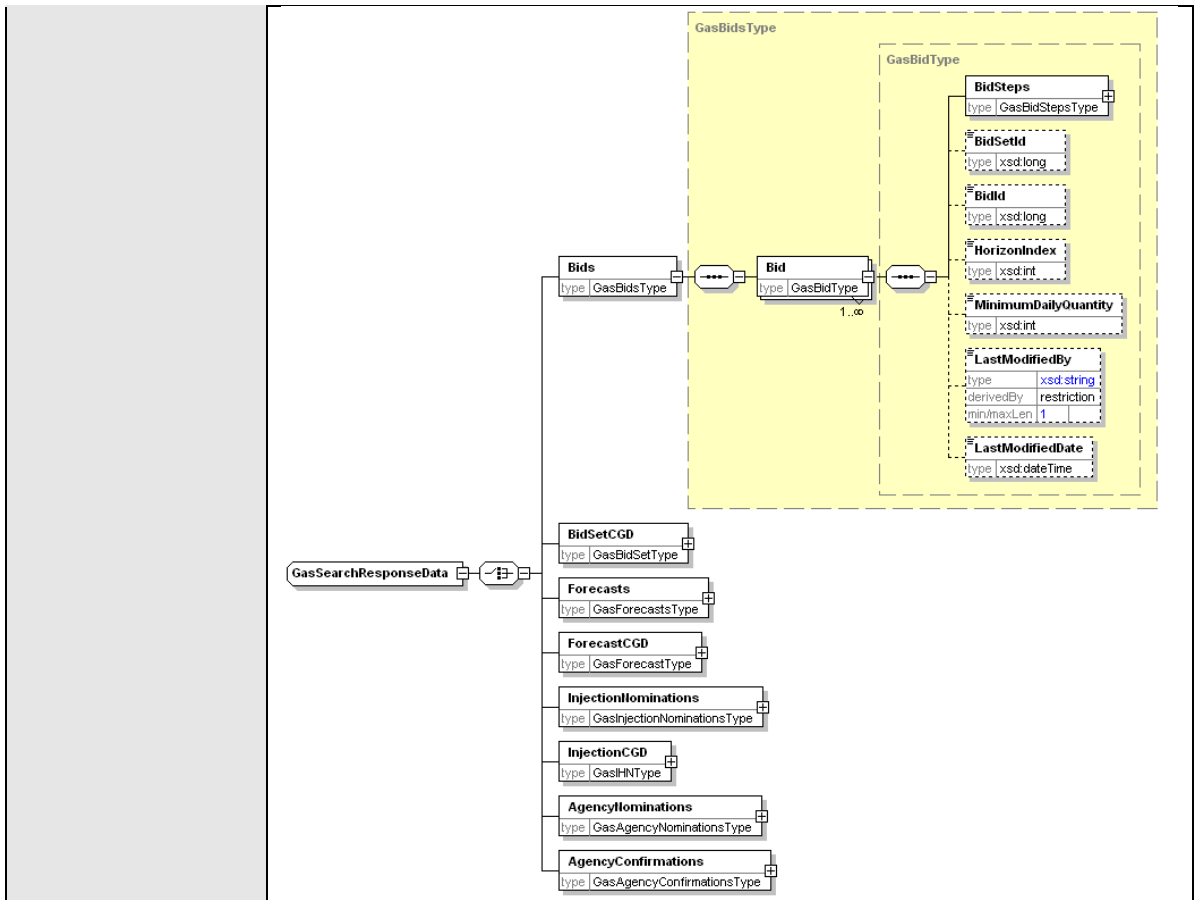

5.4.4.3 SOAP Faults

Fault Code	Fault Description
Global SOAP Faults	Refer to Global Fault Codes on page 61

#### 5.4.4.4 Usage example

##### Request Sample

```

<ase:aseXML xmlns:ase="urn:aseXML:r31">
  <Header>
    <From>VENCorp WebExchanger Recipient</From>
    <To>VENCorp WebExchanger</To>
    <MessageID>A37BEA40-3774-0678-A834-66F384852F5A</MessageID>
    <MessageDate>2006-03-16T16:56:31.805+10:00</MessageDate>
    <TransactionGroup>MKTW</TransactionGroup>
    <Priority>Medium</Priority>
    <Market>VICGAS</Market>
  </Header>
  <Transactions>
    <Transaction transactionID="A37BEA40-3774-0678-A834-66F384852F5A"
      transactionDate="2006-03-16T16:56:31.805+10:00">
      <WholesaleSearchRequest version="r20">
        <SearchRequestData version="r30" contextType="Bid"
          xsi:type="urn:GasSearchRequestData"
          xmlns:urn="urn:aseXML:r31"
          xmlns:xsi="http://www.w3.org/2001/XMLSchema-instance">
          <BidSearch>
            <BidType>INJEC</BidType>
            <NMI>30000001PC</NMI>
            <Period>
              <BeginDate>2010-01-03+10:00</BeginDate>
              <EndDate>2010-01-11+10:00</EndDate>
            </Period>
          </BidSearch>
        </SearchRequestData>
      </WholesaleSearchRequest>
    </Transaction>
  </Transactions>
</ase:aseXML>

```

## Response Sample

```

<ase:aseXML xmlns:ase="urn:aseXML:r31">
<Header>
  <From>VENCorp WebExchanger</From>
  <To>VENCorp WebExchanger Recipient</To>
  <MessageID>CACD4BAC-4795-94ED-3615-F40A9B21745F</MessageID>
  <MessageDate>2006-03-16T16:56:42.175+10:00</MessageDate>
  <TransactionGroup>MKTW</TransactionGroup>
  <Priority>Medium</Priority>
  <Market>VICGAS</Market>
</Header>
<Transactions>
  <Transaction transactionID="CACD4BAC-4795-94ED-3615-F40A9B21745F"
    transactionDate="2006-03-16T16:56:42.175+10:00">
    <WholesaleSearchResponse version="r20">
      <SearchResponseData contextType="Bid"
        xsi:type="urn:GasSearchResponseData"
        xmlns:urn="urn:aseXML:r31"
        xmlns:xsi="http://www.w3.org/2001/XMLSchema-instance">
        <Bids>
          <Bid>
            <BidSteps>
              <BidStep>
                <Step>1</Step>
                <Price>4.01</Price>
                <DailyQuantity>4820</DailyQuantity>
                <BidId>10009</BidId>
                <LastModifiedBy>TEST</LastModifiedBy>
                <LastModifiedDate>2006-03-16T10:33:01.723+10:00</LastModifiedDate>
              </BidStep>
              <BidStep>
                <Step>2</Step>
                <Price>4.02</Price>
                <DailyQuantity>4920</DailyQuantity>
                <BidId>10009</BidId>
                <LastModifiedBy>TEST</LastModifiedBy>
                <LastModifiedDate>2006-03-16T10:33:01.723+10:00</LastModifiedDate>
              </BidStep>
            </BidSteps>
            <BidSetId>20009</BidSetId>
            <BidId>10009</BidId>
            <HorizonIndex>1</HorizonIndex>
            <MinimumDailyQuantity>1234</MinimumDailyQuantity>
            <LastModifiedBy>TEST</LastModifiedBy>
            <LastModifiedDate>2006-03-16T14:27:57.660+10:00</LastModifiedDate>
          </Bid>
          <Bid>
            <BidSteps>
              <BidStep>
                <Step>1</Step>
                <Price>4.01</Price>
                <DailyQuantity>4820</DailyQuantity>
                <BidId>10010</BidId>
                <LastModifiedBy>TEST</LastModifiedBy>
                <LastModifiedDate>2006-03-16T10:33:01.723+10:00</LastModifiedDate>
              </BidStep>
              <BidStep>
                <Step>2</Step>
                <Price>4.02</Price>
                <DailyQuantity>4920</DailyQuantity>
                <BidId>10010</BidId>
                <LastModifiedBy>TEST</LastModifiedBy>
                <LastModifiedDate>2006-03-16T10:33:01.723+10:00</LastModifiedDate>
              </BidStep>
            </BidSteps>
            <BidSetId>20009</BidSetId>
            <BidId>10010</BidId>
            <HorizonIndex>2</HorizonIndex>
            <MinimumDailyQuantity>1234</MinimumDailyQuantity>
          </Bid>
        </Bids>
      </SearchResponseData>
    </WholesaleSearchResponse>
  </Transaction>
</Transactions>

```

```

        <LastModifiedBy>TEST</LastModifiedBy>
        <LastModifiedDate>2006-03-16T14:27:57.756+10:00</LastModifiedDate>
    </Bid>
    <Bid>
        <BidSteps>
            <BidStep>
                <Step>1</Step>
                <Price>4.01</Price>
                <DailyQuantity>4820</DailyQuantity>
                <BidId>10011</BidId>
                <LastModifiedBy>TEST</LastModifiedBy>
                <LastModifiedDate>2006-03-16T10:33:01.723+10:00</LastModifiedDate>
            </BidStep>
            <BidStep>
                <Step>2</Step>
                <Price>4.02</Price>
                <DailyQuantity>4920</DailyQuantity>
                <BidId>10011</BidId>
                <LastModifiedBy>TEST</LastModifiedBy>
                <LastModifiedDate>2006-03-16T10:33:01.723+10:00</LastModifiedDate>
            </BidStep>
        </BidSteps>
        <BidSetId>20010</BidSetId>
        <BidId>10011</BidId>
        <HorizonIndex>1</HorizonIndex>
        <MinimumDailyQuantity>1234</MinimumDailyQuantity>
        <LastModifiedBy>TEST</LastModifiedBy>
        <LastModifiedDate>2006-03-16T14:27:57.760+10:00</LastModifiedDate>
    </Bid>
    <Bid>
        <BidSteps>
            <BidStep>
                <Step>1</Step>
                <Price>4.01</Price>
                <DailyQuantity>4820</DailyQuantity>
                <BidId>10012</BidId>
                <LastModifiedBy>TEST</LastModifiedBy>
                <LastModifiedDate>2006-03-16T10:33:01.723+10:00</LastModifiedDate>
            </BidStep>
            <BidStep>
                <Step>2</Step>
                <Price>4.02</Price>
                <DailyQuantity>4920</DailyQuantity>
                <BidId>10012</BidId>
                <LastModifiedBy>TEST</LastModifiedBy>
                <LastModifiedDate>2006-03-16T10:33:01.723+10:00</LastModifiedDate>
            </BidStep>
        </BidSteps>
        <BidSetId>20010</BidSetId>
        <BidId>10012</BidId>
        <HorizonIndex>2</HorizonIndex>
        <MinimumDailyQuantity>1234</MinimumDailyQuantity>
        <LastModifiedBy>TEST</LastModifiedBy>
        <LastModifiedDate>2006-03-16T14:27:57.760+10:00</LastModifiedDate>
    </Bid>
</Bids>
</SearchResponseData>
</WholesaleSearchResponse>
</Transaction>
</Transactions>
</ase:aseXML>
    
```



## 5.4.5 SubmitBid

### 5.4.5.1 Description

The `submitBid()` method submits bid information for processing by the WebExchanger application, using the supplied date range, bid type and price/quantity information.

SOAP faults will be generated if the submission is not accepted due to missing the interval cutoff time and for other reasons. The possible SOAP faults are documented below along with the potential causes of the faults.

Note 1: In the request, `BidSetId` and `BidId`, `HorizonIndex` and `CompanyId` need not to be populated. The response will have these values set by the WebExchanger application. If provided, the values in the request will be ignored.

Note 2: In the request, if optional `applyTo` attribute is provided for current gas day, day ahead or two days ahead submission, then any values specified in the `Period` element will be ignored. The submission period will be automatically calculated by WebExchanger based on the current time. It is recommended that the `applyTo` attribute to be used for this type of the submission.

Note 3: In the request, if `applyTo` is set to "Standing", then the `Period` element must be populated with the correct values. The `Period's EndDate` (a.k.a. termination date) must be at least one day ahead of `BeginDate`. The `EndDate` is not inclusive.

Note 4: Only one `GasBidType` can be provided in the request.



Request Parameter:

Complex type	GasBidSetType
--------------	---------------

Request Attributes:

<code>xsi:type</code>	GasSubmitRequestData
<code>context</code>	Bid
<code>applyTo</code>	GasSubmissionType



Response Parameter:

Complex type	GasBidSetType
--------------	---------------

Response Attributes:

<code>xsi:type</code>	GasSubmitResponseData
-----------------------	-----------------------

context	Bid
---------	-----

### 5.4.5.2 Input/Output Parameters

<b>Input Element</b>	GasSubmitRequestData
<b>Input Schema</b>	<pre> &lt;xsd:complexType name="GasSubmitRequestData"&gt;   &lt;xsd:complexContent&gt;     &lt;xsd:extension base="WholesaleSubmitRequestData"&gt;       &lt;xsd:choice&gt;         ...         &lt;xsd:element name="BidSet" type="GasBidSetType"/&gt;         ...       &lt;/xsd:choice&gt;       &lt;xsd:attribute name="version" type="r31" use="optional"         default="r31"/&gt;       &lt;xsd:attribute         name="contextType"         type="GasSubmissionTransactionType"         use="required"/&gt;       &lt;xsd:attribute         name="applyTo"         type="GasSubmissionType"         use="optional"/&gt;     &lt;/xsd:extension&gt;   &lt;/xsd:complexContent&gt; &lt;/xsd:complexType&gt; </pre>

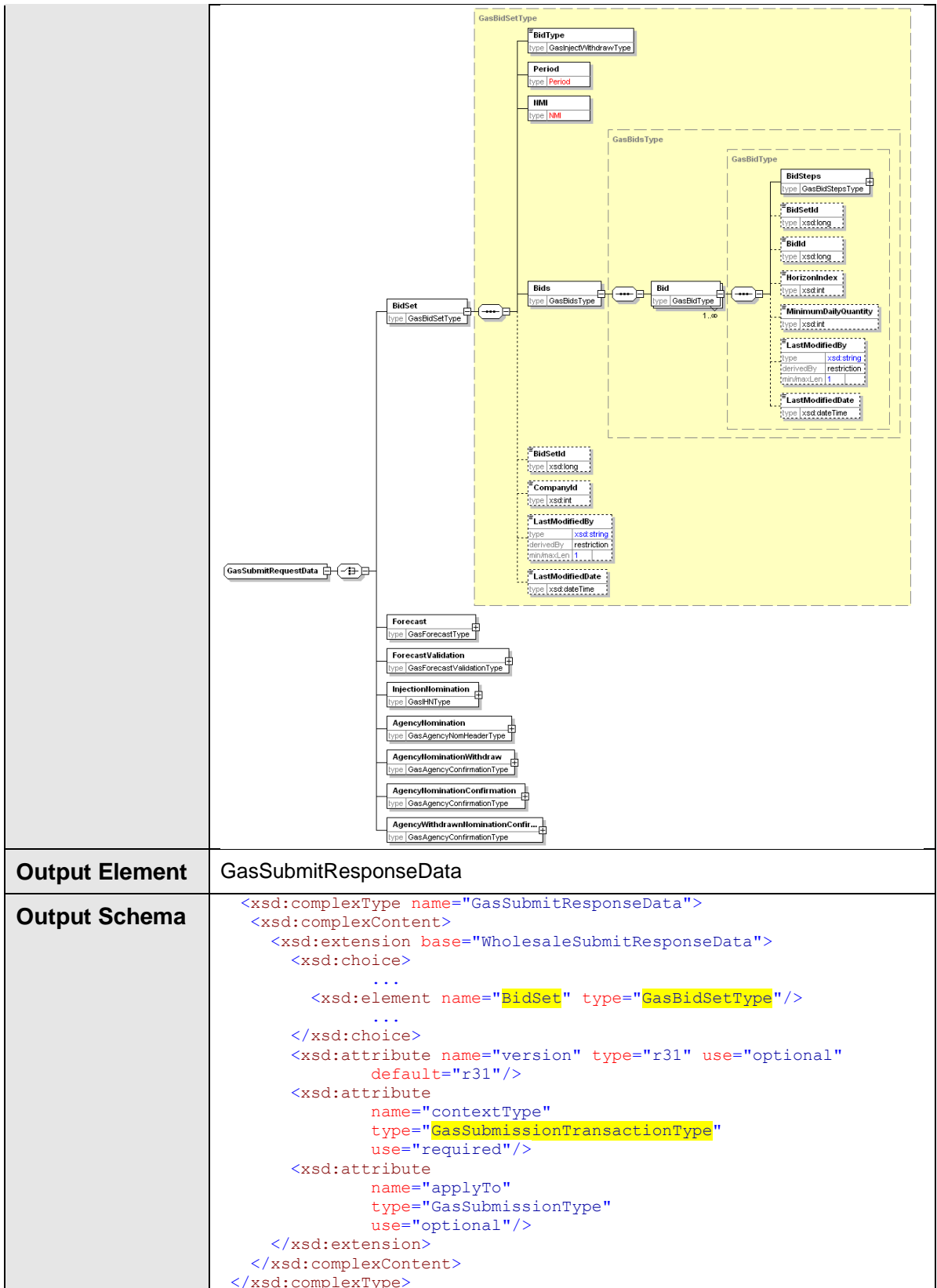

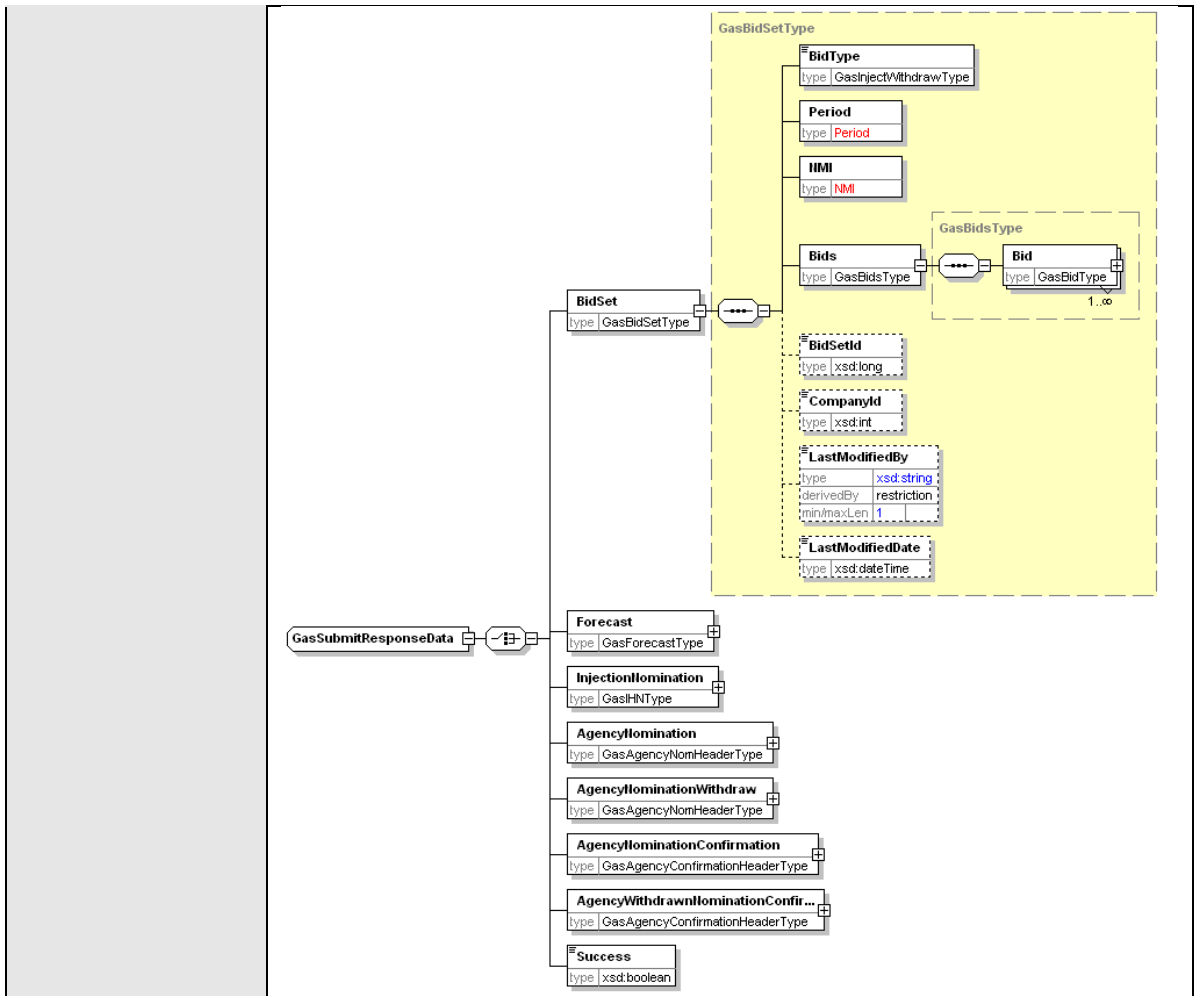

5.4.5.3 SOAP Faults

Fault Code	Fault Description
Global SOAP Faults	Refer to Global Fault Codes on page 61
3502	Submission interval has expired.
3503	Invalid gas bid type – only one GasBidType can be supplied
3504	Invalid bid price - price cannot be negative.
3505	Invalid bid price - price cannot be greater than current Value Of Lost Load value.
3506	Invalid bid price - price cannot have gaps between bid steps.
3507	Invalid daily quantity - quantity cannot be negative.
3508	Invalid daily quantity - quantity of gas associated with the highest priced bid step must be equal to or exceed the sum of the scheduled quantity over all preceding and current scheduling intervals of the current gas day: [minimum rebid quantity] GJ.

Fault Code	Fault Description
3509	Invalid daily quantity - quantity of gas associated with the lowest priced bid step must be equal to or exceed the sum of the scheduled quantity over all preceding and current scheduling intervals of the current gas day: [minimum rebid quantity] GJ.
3510	Invalid daily quantity - quantity cannot have gaps between bid steps.
3511	This error code is no longer in use
3512	This error code is no longer in use
3513	This error code is no longer in use
3514	Invalid bid step - bid steps for an injection bid must have a price and quantity that is higher then the previous bid step.
3515	Invalid bid step - bid steps for a withdrawal bid must have a price that is lower and a quantity that is higher than the previous bid step.
3516	Invalid bid step - bid steps must have no gaps and increment from one. eg. 1,2,3,4,etc.
3517	Invalid bid step - at least one bid step with price and quantity must be supplied.
3518	Invalid daily quantity - quantity cannot be zero.
3519	Invalid mininium daily quantity - quantity can only be zero. Please edit the supplied value to zero.

#### 5.4.5.4 Usage example

##### Request Sample

```

<ase:aseXML xmlns:ase="urn:aseXML:r31">
<Header>
<From>VENCorp WebExchanger Recipient</From>
<To>VENCorp WebExchanger</To>
<MessageID>BDB22363-F16D-AA3E-C4CA-652400F6F0EF</MessageID>
<MessageDate>2006-03-24T11:20:08.030+10:00</MessageDate>
<TransactionGroup>MKTW</TransactionGroup>
<Priority>Medium</Priority>
<Market>VICGAS</Market>
</Header>
<Transactions>
<Transaction transactionID="BDB22363-F16D-AA3E-C4CA-652400F6F0EF"
transactionDate="2006-03-24T11:20:08.030+10:00">
<WholesaleSubmitRequest version="r20">
<SubmitRequestData
applyTo="Standing"
version="r31"
contextType="Bid"
xsi:type="urn:GasSubmitRequestData"
xmlns:urn="urn:aseXML:r31"
xmlns:xsi="http://www.w3.org/2001/XMLSchema-instance">
<BidSet>
<BidType>INJEC</BidType>
<Period>
<BeginDate>2007-06-01+10:00</BeginDate>
<EndDate>2007-06-11+10:00</EndDate>
</Period>
<NMI>30000001PC</NMI>
<Bids>
<Bid>
<BidSteps>
<BidStep>
<Step>1</Step>
<Price>2.8564</Price>
<DailyQuantity>220</DailyQuantity>
</BidStep>
</BidSteps>
<MinimumDailyQuantity>120</MinimumDailyQuantity>
</Bid>
</Bids>
</BidSet>
</SubmitRequestData>
</WholesaleSubmitRequest>
</Transaction>
</Transactions>
</ase:aseXML>

```

## Response Sample

```

<ase:aseXML xmlns:ase="urn:aseXML:r31">
  <Header>
    <From>VENCorp WebExchanger</From>
    <To>VENCorp WebExchanger Recipient</To>
    <MessageID>EE3C360D-001C-B5C3-38F6-DE5FEAD26969</MessageID>
    <MessageDate>2006-03-24T11:46:45.856+10:00</MessageDate>
    <TransactionGroup>MKTW</TransactionGroup>
    <Priority>Medium</Priority>
    <Market>VICGAS</Market>
  </Header>
  <Transactions>
    <Transaction transactionID="EE3C360D-001C-B5C3-38F6-DE5FEAD26969"
      transactionDate="2006-03-24T11:46:45.856+10:00">
      <WholesaleSubmitResponse version="r20">
        <SubmitResponseData
          contextType="Bid"
          xsi:type="urn:GasSubmitResponseData"
          xmlns:urn="urn:aseXML:r31"
          xmlns:xsi="http://www.w3.org/2001/XMLSchema-instance">
          <BidSet>
            <BidType>INJEC</BidType>
            <Period>
              <BeginDate>2007-06-01+10:00</BeginDate>
              <EndDate>2007-06-11+10:00</EndDate>
            </Period>
            <NMI>30000001PC</NMI>
            <Bids>
              <Bid>
                <BidSteps>
                  <BidStep>
                    <Step>1</Step>
                    <Price>2.8564</Price>
                    <DailyQuantity>220</DailyQuantity>
                    <BidId>40690</BidId>
                    <LastModifiedBy>Wextest</LastModifiedBy>
                  </BidStep>
                </BidSteps>
                <BidSetId>68336</BidSetId>
                <BidId>40690</BidId>
                <HorizonIndex>2</HorizonIndex>
                <MinimumDailyQuantity>120</MinimumDailyQuantity>
                <LastModifiedBy>Wextest</LastModifiedBy>
              </Bid>
            </Bids>
            <BidSetId>68336</BidSetId>
            <CompanyId>10000</CompanyId>
            <LastModifiedBy>Wextest</LastModifiedBy>
          </BidSet>
        </SubmitResponseData>
      </WholesaleSubmitResponse>
    </Transaction>
  </Transactions>
</ase:aseXML>

```

## 5.5 Web Service: Demand Forecast Service

### 5.5.1 Introduction

The Demand Forecast Service is responsible for all demand forecast-related functionality, including retrieving forecast data and submitting new forecast information to the WebExchanger application.

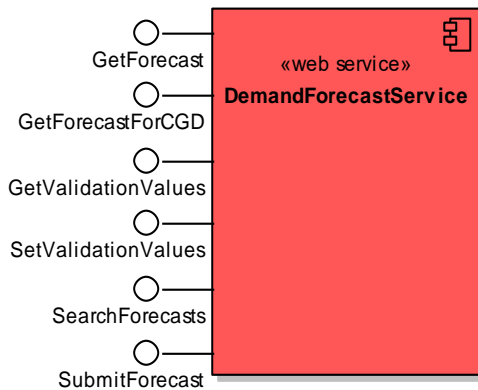

The service provides the following operations:

- GetForecast
- GetForecastForCGD
- GetValidationValues
- SetValidationValues
- SearchForecasts
- SubmitForecast

### 5.5.2 GetForecast

#### 5.5.2.1 Description

The `getForecast()` method obtains all the data for a particular demand forecast based on its demand forecast identifier in the AEMO system (Demand Forecast ID), including the individual hourly values that comprise the forecast.

Only forecasts submitted by the logged in user, or another user within the same company/organization, will be viewable using this method.



Request Parameter:

Simple type	ForecastId
-------------	------------



Request Attributes:

xsi:type	GasRetrieveRequestData
context	Forecast



Response Parameter:

Complex type	GasForecastType
--------------	-----------------

Response Attributes:

xsi:type	GasRetrieveResponseData
context	Forecast

Note 1: The `ForecastValues` will be provided in the order where the first value is for 00:00 through to the last value for 23:00. Optional attribute `hour` may contain the corresponding hour description.

5.5.2.2 Input/Output Parameters

Input Element	GasRetrieveRequestData
Input Schema	<pre> &lt;xsd:complexType name="GasRetrieveRequestData"&gt;   &lt;xsd:complexContent&gt;     &lt;xsd:extension base="WholesaleRetrieveRequestData"&gt;       &lt;xsd:choice&gt;         ...         &lt;xsd:element name="ForecastId" type="xsd:long"/&gt;         ...       &lt;/xsd:choice&gt;       &lt;xsd:attribute         name="version"         type="r30"         use="optional"         default="r30"/&gt;       &lt;xsd:attribute name="contextType"         type="GasRetrieveTransactionType"         use="required"/&gt;     &lt;/xsd:extension&gt;   &lt;/xsd:complexContent&gt; &lt;/xsd:complexType&gt; </pre>

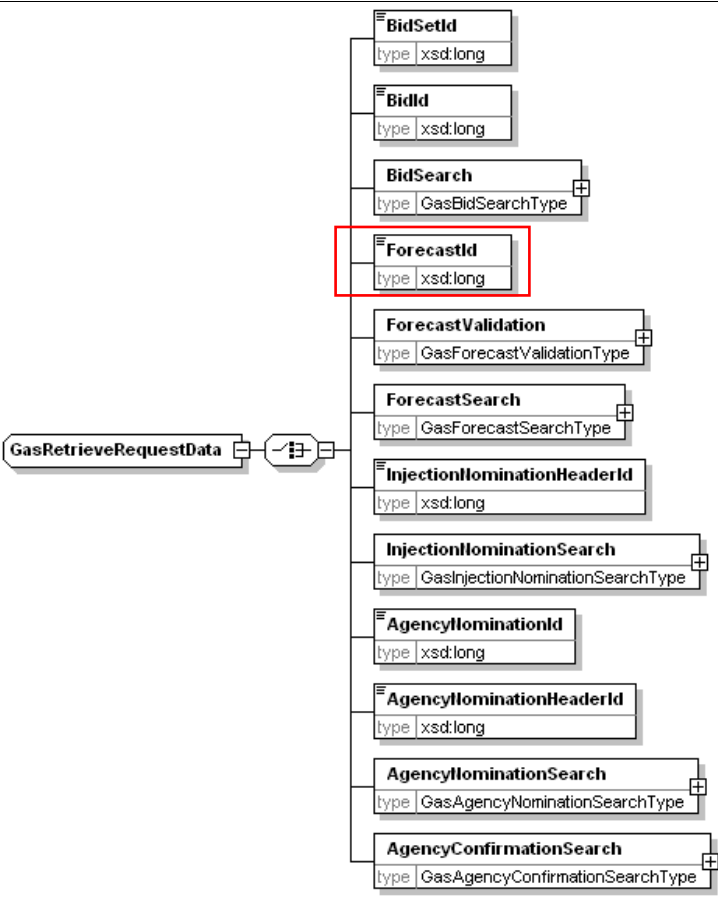
	
<p><b>Output Element</b></p>	<p>GasRetrieveResponseData</p>
<p><b>Output Schema</b></p>	<pre> &lt;xsd:complexType name="GasRetrieveResponseData"&gt;   &lt;xsd:complexContent&gt;     &lt;xsd:extension base="WholesaleRetrieveResponseData"&gt;       &lt;xsd:sequence&gt;         &lt;xsd:choice&gt;           ...           &lt;xsd:element name="Forecast" type="GasForecastType"/&gt;           ...         &lt;/xsd:choice&gt;       &lt;/xsd:sequence&gt;       &lt;xsd:attribute         name="version"         type="r31"         use="optional"         default="r31"/&gt;       &lt;xsd:attribute name="contextType"         type="GasRetrieveTransactionType"         use="required"/&gt;     &lt;/xsd:extension&gt;   &lt;/xsd:complexContent&gt; &lt;/xsd:complexType&gt;         </pre>

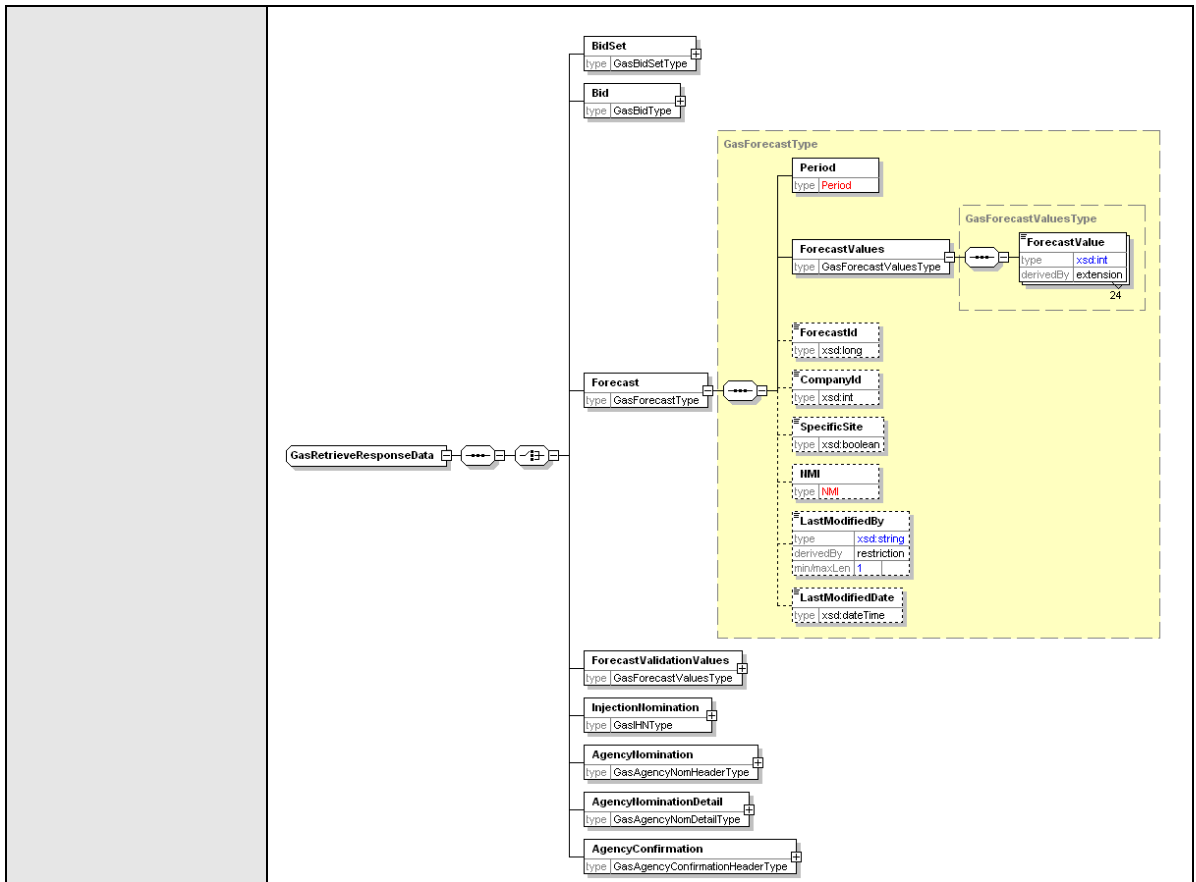

5.5.2.3 SOAP Faults

Fault Code	Fault Description
Global SOAP Faults	Refer to Global Fault Codes on page 61

### 5.5.2.4 Usage example

#### Request Sample

```
<ase:aseXML xmlns:ase="urn:aseXML:r31">
  <Header>
    <From>VENCorp WebExchanger Recipient</From>
    <To>VENCorp WebExchanger</To>
    <MessageID>55E9B2BD-22F0-4BF5-A570-73B467A1597E</MessageID>
    <MessageDate>2006-03-17T09:31:56.922+10:00</MessageDate>
    <TransactionGroup>MKTW</TransactionGroup>
    <Priority>Medium</Priority>
    <Market>VICGAS</Market>
  </Header>
  <Transactions>
    <Transaction transactionID="55E9B2BD-22F0-4BF5-A570-73B467A1597E"
      transactionDate="2006-03-17T09:31:56.922+10:00">
      <WholesaleRetrieveRequest version="r20">
        <RetrieveRequestData
          version="r30"
          contextType="Forecast"
          xsi:type="urn:GasRetrieveRequestData"
          xmlns:urn="urn:aseXML:r31"
          xmlns:xsi="http://www.w3.org/2001/XMLSchema-instance">
          <ForecastId>10000</ForecastId>
        </RetrieveRequestData>
      </WholesaleRetrieveRequest>
    </Transaction>
  </Transactions>
</ase:aseXML>
```

#### Response Sample

```
<ase:aseXML xmlns:ase="urn:aseXML:r31">
  <Header>
    <From>VENCorp WebExchanger</From>
    <To>VENCorp WebExchanger Recipient</To>
    <MessageID>0E95D6FF-5982-7284-165A-6B412738343A</MessageID>
    <MessageDate>2006-03-17T09:32:07.868+10:00</MessageDate>
    <TransactionGroup>MKTW</TransactionGroup>
    <Priority>Medium</Priority>
    <Market>VICGAS</Market>
  </Header>
  <Transactions>
    <Transaction transactionID="0E95D6FF-5982-7284-165A-6B412738343A"
      transactionDate="2006-03-17T09:32:07.868+10:00">
      <WholesaleRetrieveResponse version="r20">
        <RetrieveResponseData
          contextType="Forecast"
          xsi:type="urn:GasRetrieveResponseData"
          xmlns:urn="urn:aseXML:r31"
          xmlns:xsi="http://www.w3.org/2001/XMLSchema-instance">
          <Forecast>
            <Period>
              <BeginDate>2005-01-01+10:00</BeginDate>
              <EndDate>2005-02-01+10:00</EndDate>
            </Period>
            <ForecastValues>
              <ForecastValue hour="00:00:00">1</ForecastValue>
              <ForecastValue hour="01:00:00">2</ForecastValue>
              <ForecastValue hour="02:00:00">3</ForecastValue>
              <ForecastValue hour="03:00:00">4</ForecastValue>
              <ForecastValue hour="04:00:00">5</ForecastValue>
              <ForecastValue hour="05:00:00">6</ForecastValue>
              <ForecastValue hour="06:00:00">7</ForecastValue>
              <ForecastValue hour="07:00:00">8</ForecastValue>
              <ForecastValue hour="08:00:00">9</ForecastValue>
            </ForecastValues>
          </RetrieveResponseData>
        </WholesaleRetrieveResponse>
      </Transaction>
    </Transactions>
  </ase:aseXML>
```

```
<ForecastValue hour="09:00:00">10</ForecastValue>
<ForecastValue hour="10:00:00">11</ForecastValue>
<ForecastValue hour="11:00:00">12</ForecastValue>
<ForecastValue hour="12:00:00">13</ForecastValue>
<ForecastValue hour="13:00:00">14</ForecastValue>
<ForecastValue hour="14:00:00">15</ForecastValue>
<ForecastValue hour="15:00:00">16</ForecastValue>
<ForecastValue hour="16:00:00">17</ForecastValue>
<ForecastValue hour="17:00:00">18</ForecastValue>
<ForecastValue hour="18:00:00">19</ForecastValue>
<ForecastValue hour="19:00:00">20</ForecastValue>
<ForecastValue hour="20:00:00">21</ForecastValue>
<ForecastValue hour="21:00:00">22</ForecastValue>
<ForecastValue hour="22:00:00">23</ForecastValue>
<ForecastValue hour="23:00:00">24</ForecastValue>
</ForecastValues>
<ForecastId>10000</ForecastId>
<CompanyId>10000</CompanyId>
<SpecificSite>>false</SpecificSite>
<LastModifiedBy>TEST</LastModifiedBy>
<LastModifiedDate>2006-03-16T14:27:57.960+10:00</LastModifiedDate>
</Forecast>
</RetrieveResponseData>
</WholesaleRetrieveResponse>
</Transaction>
</Transactions>
</ase:aseXML>
```

### 5.5.3 GetForecastForCGD

#### 5.5.3.1 Description

The `getForecastForCGD()` method obtains all the data for the latest demand forecast for the current gas day. This is a convenience method as the same data can be obtained via the related `getForecast()` or `searchForecasts()` calls.

Only forecasts submitted by the logged in user, or another user within the same company/organization, will be viewable using this method.



Request Parameter:

Complex type	GasForecastSearchType
--------------	-----------------------

Request Attributes:

xsi:type	GasRetrieveRequestData
context	ForecastCGD



Response Parameter:

Complex type	GasForecastType
--------------	-----------------

Response Attributes:

xsi:type	GasRetrieveResponseData
context	ForecastCGD

Note 1: if `SpecificSite` element is set to `true`, then the meter identifier (MIRN/NMI) must be provided. If `SpecificSite` value is set to `false` and meter identifier is provided, it will be ignored.

Note 2: The values in `Period` element will be ignored, if provided.

Note 3: The `ForecastValues` will be provided in the order where the first value is for 00:00 through to the last value for 23:00. Optional attribute `hour` may contain the actual hour description.

#### 5.5.3.2 Input/Output Parameters

<b>Input Element</b>	GasRetrieveRequestData
<b>Input Schema</b>	<pre> &lt;xsd:complexType name="GasRetrieveRequestData"&gt;   &lt;xsd:complexContent&gt;     &lt;xsd:extension base="WholesaleRetrieveRequestData"&gt; </pre>

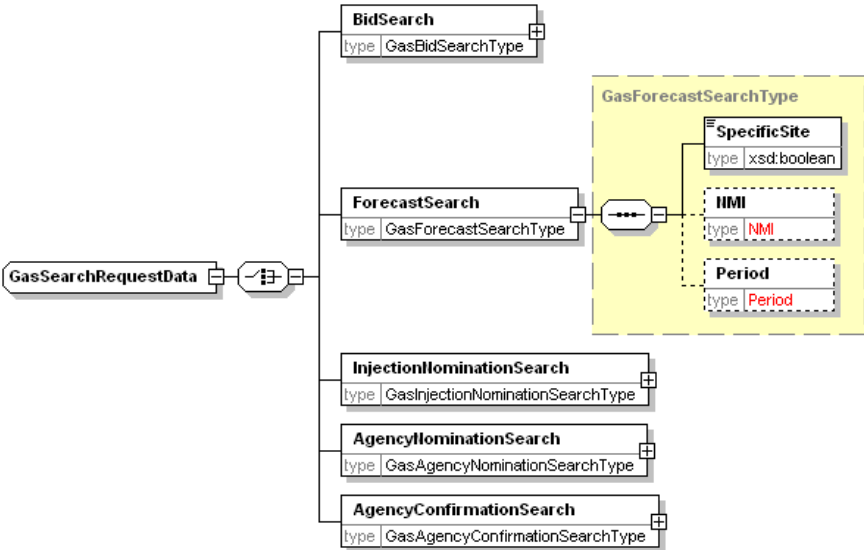
	<pre> &lt;xsd:choice&gt;   ...   &lt;xsd:element name="ForecastSearch"     type="GasForecastSearchType"/&gt;   ... &lt;/xsd:choice&gt; &lt;xsd:attribute   name="version"   type="r30"   use="optional"   default="r30"/&gt; &lt;xsd:attribute name="contextType"   type="GasRetrieveTransactionType"   use="required"/&gt; &lt;/xsd:extension&gt; &lt;/xsd:complexContent&gt; &lt;/xsd:complexType&gt;         </pre> 
<b>Output Element</b>	GasRetrieveResponseData
<b>Output Schema</b>	<pre> &lt;xsd:complexType name="GasRetrieveResponseData"&gt;   &lt;xsd:complexContent&gt;     &lt;xsd:extension base="WholesaleRetrieveResponseData"&gt;       &lt;xsd:sequence&gt;         &lt;xsd:choice&gt;           ...           &lt;xsd:element name="Forecast" type="GasForecastType"/&gt;           ...         &lt;/xsd:choice&gt;       &lt;/xsd:sequence&gt;       &lt;xsd:attribute name="version"         type="r31"         use="optional"         default="r31"/&gt;       &lt;xsd:attribute name="contextType"         type="GasRetrieveTransactionType"         use="required"/&gt;     &lt;/xsd:extension&gt;   &lt;/xsd:complexContent&gt; &lt;/xsd:complexType&gt;         </pre>

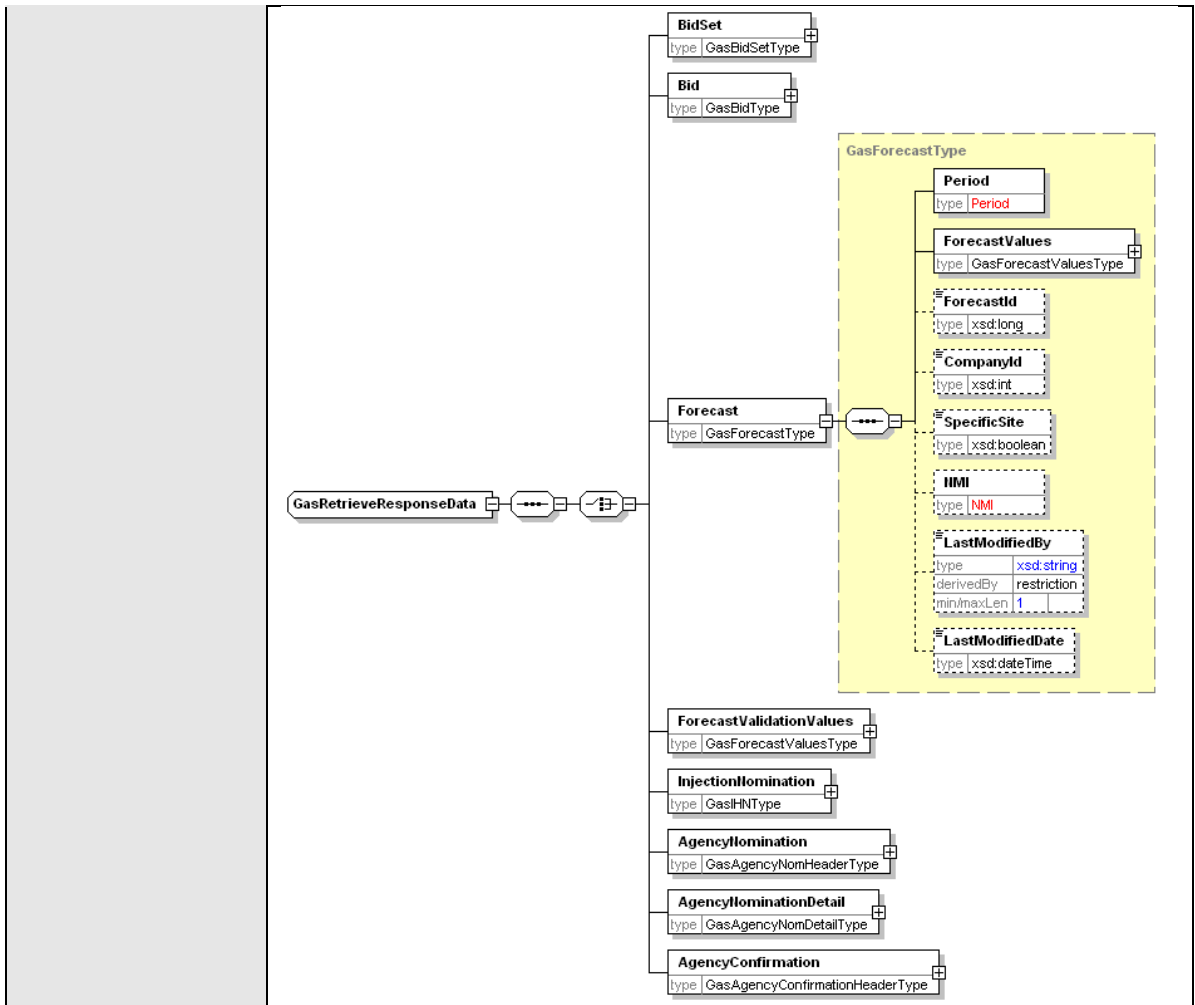

### 5.5.3.3 SOAP Faults

Fault Code	Fault Description
Global SOAP Faults	Refer to Global Fault Codes on page 61



### 5.5.3.4 Usage example

#### Request Sample

```
<ase:aseXML xmlns:ase="urn:aseXML:r31">
  <Header>
    <From>VENCorp WebExchanger Recipient</From>
    <To>VENCorp WebExchanger</To>
    <MessageID>979A027E-B795-523D-EC70-16E87CD0425A</MessageID>
    <MessageDate>2006-03-17T09:46:54.273+10:00</MessageDate>
    <TransactionGroup>MKTW</TransactionGroup>
    <Priority>Medium</Priority>
    <Market>VICGAS</Market>
  </Header>
  <Transactions>
    <Transaction transactionID="979A027E-B795-523D-EC70-16E87CD0425A"
      transactionDate="2006-03-17T09:46:54.273+10:00">
      <WholesaleRetrieveRequest version="r20">
        <RetrieveRequestData version="r30"
          contextType="ForecastCGD"
          xsi:type="urn:GasRetrieveRequestData"
          xmlns:urn="urn:aseXML:r31"
          xmlns:xsi="http://www.w3.org/2001/XMLSchema-instance">
          <ForecastSearch>
            <SpecificSite>>false</SpecificSite>
          </ForecastSearch>
        </RetrieveRequestData>
      </WholesaleRetrieveRequest>
    </Transaction>
  </Transactions>
</ase:aseXML>
```

#### Response Sample

```
<ase:aseXML xmlns:ase="urn:aseXML:r31">
  <Header>
    <From>VENCorp WebExchanger</From>
    <To>VENCorp WebExchanger Recipient</To>
    <MessageID>A0C6365B-2621-7DD6-4BDE-D3365311C834</MessageID>
    <MessageDate>2006-03-17T09:53:48.304+10:00</MessageDate>
    <TransactionGroup>MKTW</TransactionGroup>
    <Priority>Medium</Priority>
    <Market>VICGAS</Market>
  </Header>
  <Transactions>
    <Transaction transactionID="A0C6365B-2621-7DD6-4BDE-D3365311C834"
      transactionDate="2006-03-17T09:53:48.304+10:00">
      <WholesaleRetrieveResponse version="r20">
        <RetrieveResponseData contextType="ForecastCGD"
          xsi:type="urn:GasRetrieveResponseData"
          xmlns:urn="urn:aseXML:r31"
          xmlns:xsi="http://www.w3.org/2001/XMLSchema-instance">
          <Forecast>
            <Period>
              <BeginDate>2006-03-17+10:00</BeginDate>
              <EndDate>2006-03-18+10:00</EndDate>
            </Period>
            <ForecastValues>
              <ForecastValue hour="00:00:00">19</ForecastValue>
              <ForecastValue hour="01:00:00">20</ForecastValue>
              <ForecastValue hour="02:00:00">21</ForecastValue>
              <ForecastValue hour="03:00:00">22</ForecastValue>
              <ForecastValue hour="04:00:00">23</ForecastValue>
              <ForecastValue hour="05:00:00">24</ForecastValue>
              <ForecastValue hour="06:00:00">1</ForecastValue>
              <ForecastValue hour="07:00:00">2</ForecastValue>
              <ForecastValue hour="08:00:00">3</ForecastValue>
            </ForecastValues>
          </RetrieveResponseData>
        </WholesaleRetrieveResponse>
      </Transaction>
    </Transactions>
  </ase:aseXML>
```

```

        <ForecastValue hour="09:00:00">4</ForecastValue>
        <ForecastValue hour="10:00:00">5</ForecastValue>
        <ForecastValue hour="11:00:00">6</ForecastValue>
        <ForecastValue hour="12:00:00">7</ForecastValue>
        <ForecastValue hour="13:00:00">8</ForecastValue>
        <ForecastValue hour="14:00:00">9</ForecastValue>
        <ForecastValue hour="15:00:00">10</ForecastValue>
        <ForecastValue hour="16:00:00">11</ForecastValue>
        <ForecastValue hour="17:00:00">12</ForecastValue>
        <ForecastValue hour="18:00:00">13</ForecastValue>
        <ForecastValue hour="19:00:00">14</ForecastValue>
        <ForecastValue hour="20:00:00">15</ForecastValue>
        <ForecastValue hour="21:00:00">16</ForecastValue>
        <ForecastValue hour="22:00:00">17</ForecastValue>
        <ForecastValue hour="23:00:00">18</ForecastValue>
    </ForecastValues>
    <ForecastId>50081</ForecastId>
    <CompanyId>10000</CompanyId>
    <SpecificSite>>false</SpecificSite>
    <LastModifiedBy>Wextest</LastModifiedBy>
    <LastModifiedDate>2006-03-14T13:28:32.176+10:00</LastModifiedDate>
</Forecast>
</RetrieveResponseData>
</WholesaleRetrieveResponse>
</Transaction>
</Transactions>
</ase:aseXML>
    
```

## 5.5.4 GetValidationValues

### 5.5.4.1 Description

The `getValidationValues()` method retrieves the demand forecast hourly validation values optionally supplied by the participant. These values provide an upper limit on the forecast values that can be entered by the participant for demand forecasts, either through the web front end or via SOAP. If values are not provided, the validation will not be performed.



Request Parameter:

Complex type	GasForecastValidationType
--------------	---------------------------

Request Attributes:

xsi:type	GasRetrieveRequestData
context	ForecastValidation



Response Parameter:

Complex type	GasForecastValuesType
--------------	-----------------------

Response Attributes:

xsi:type	GasRetrieveResponseData
context	ForecastValidation

Note 1: If `SpecificSite` is set to true, then `NMI` element must be populated with a valid MIRN. If `SpecificSite` is set to false, then MIRN value if provided in the `NMI` element will be ignored.

Note 2: If `ValidationValues` element in the request will be ignored, if populated.

Note 3: The `ForecastValues` retrieved will be in the order where the first value is for 00:00 through to the last value for 23:00.

5.5.4.2 Input/Output Parameters

Input Element	GasRetrieveRequestData
Input Schema	<pre> &lt;xsd:complexType name="GasRetrieveRequestData"&gt;   &lt;xsd:complexContent&gt;     &lt;xsd:extension base="WholesaleRetrieveRequestData"&gt;       &lt;xsd:choice&gt;         ...         &lt;xsd:element name="ForecastValidation"                     type="GasForecastValidationType"/&gt;         ...       &lt;/xsd:choice&gt;       &lt;xsd:attribute name="version"                     type="r30"                     use="optional"                     default="r30"/&gt;       &lt;xsd:attribute name="contextType"                     type="GasRetrieveTransactionType"                     use="required"/&gt;     &lt;/xsd:extension&gt;   &lt;/xsd:complexContent&gt; &lt;/xsd:complexType&gt; </pre>

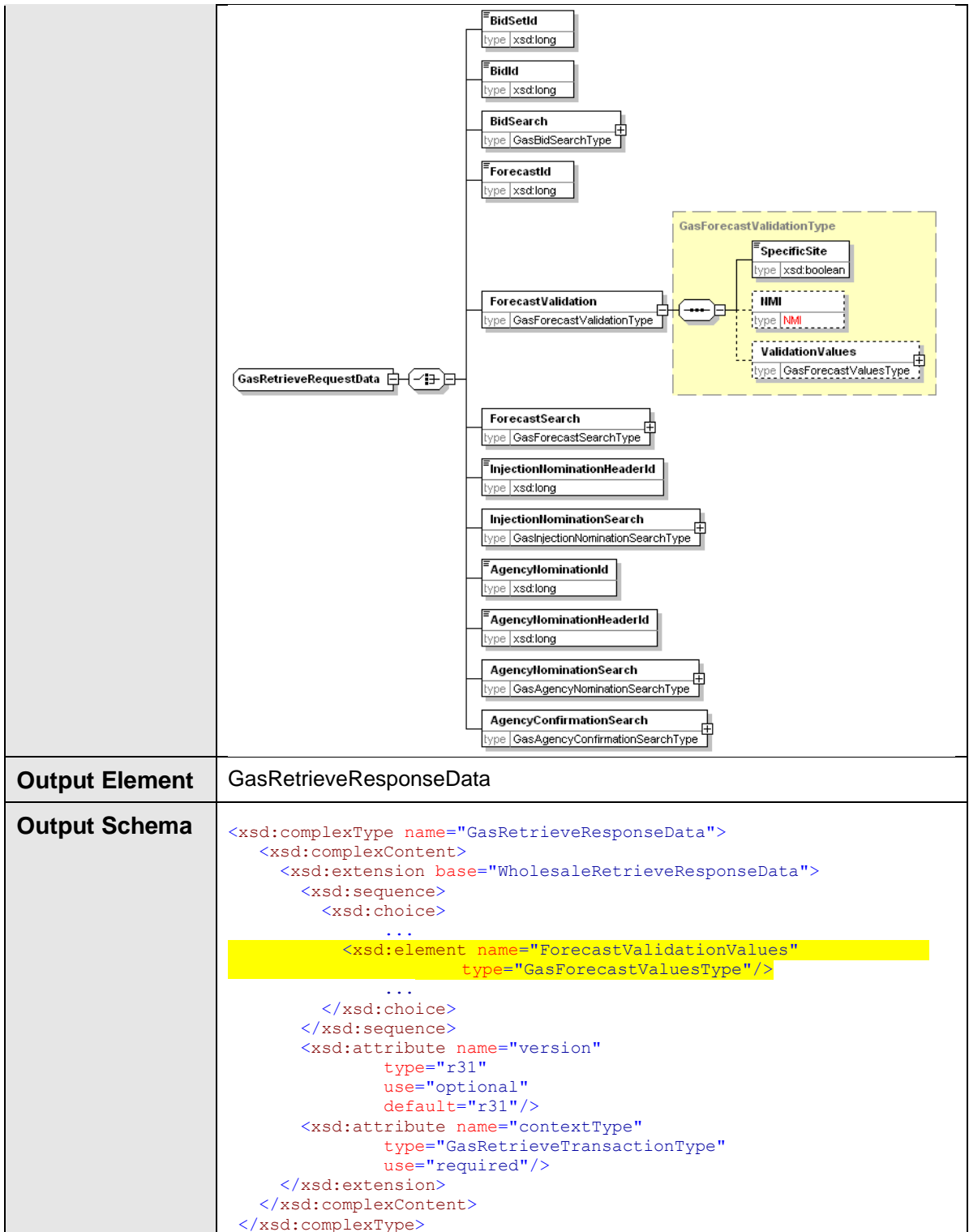

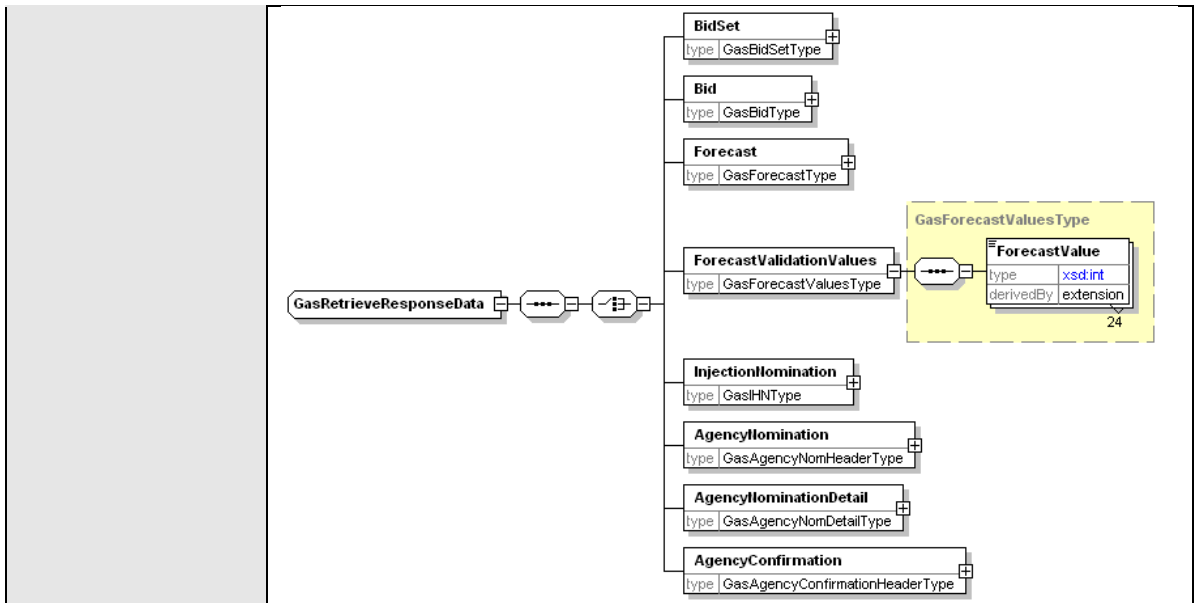

### 5.5.4.3 SOAP Faults

Fault Code	Fault Description
Global SOAP Faults	Refer to Global Fault Codes on page 61

### 5.5.4.4 Usage example

```

Request Sample

<ase:aseXML xmlns:ase="urn:aseXML:r31">
  <Header>
    <From>VENCorp WebExchanger Recipient</From>
    <To>VENCorp WebExchanger</To>
    <MessageID>C396E158-6ED5-7891-ED8D-CC47D3EF0252</MessageID>
    <MessageDate>2006-03-17T10:02:08.399+10:00</MessageDate>
    <TransactionGroup>MKTW</TransactionGroup>
    <Priority>Medium</Priority>
    <Market>VICGAS</Market>
  </Header>
  <Transactions>
    <Transaction transactionID="C396E158-6ED5-7891-ED8D-CC47D3EF0252"
      transactionDate="2006-03-17T10:02:08.399+10:00">
      <WholesaleRetrieveRequest version="r20">
        <RetrieveRequestData
          contextType="ForecastValidation"
          xsi:type="urn:GasRetrieveRequestData"
          xmlns:urn="urn:aseXML:r31"
          xmlns:xsi="http://www.w3.org/2001/XMLSchema-instance">
          <ForecastValidation>
            <SpecificSite>false</SpecificSite>
          </ForecastValidation>
        </RetrieveRequestData>
      </WholesaleRetrieveRequest>
    </Transaction>
  </Transactions>
</ase:aseXML>
    
```

**Response Sample**

```

<ase:aseXML xmlns:ase="urn:aseXML:r31">
  <Header>
    <From>VENCorp WebExchanger</From>
    <To>VENCorp WebExchanger Recipient</To>
    <MessageID>CCF0128D-65B0-B33F-2F92-B0F15D5CE9F7</MessageID>
    <MessageDate>2006-08-24T17:18:11.801+10:00</MessageDate>
    <TransactionGroup>MKTW</TransactionGroup>
    <Priority>Medium</Priority>
    <Market>VICGAS</Market>
  </Header>
  <Transactions>
    <Transaction transactionID="CCF0128D-65B0-B33F-2F92-B0F15D5CE9F7"
      transactionDate="2006-08-24T17:18:11.801+10:00">
      <WholesaleRetrieveResponse version="r20">
        <RetrieveResponseData
          contextType="ForecastValidation"
          xsi:type="urn:GasRetrieveResponseData"
          xmlns:urn="urn:aseXML:r31"
          xmlns:xsi="http://www.w3.org/2001/XMLSchema-instance">
          <ForecastValidationValues>
            <ForecastValue hour="00:00:00">19</ForecastValue>
            <ForecastValue hour="01:00:00">20</ForecastValue>
            <ForecastValue hour="02:00:00">21</ForecastValue>
            <ForecastValue hour="03:00:00">22</ForecastValue>
            <ForecastValue hour="04:00:00">23</ForecastValue>
            <ForecastValue hour="05:00:00">24</ForecastValue>
            <ForecastValue hour="06:00:00">1</ForecastValue>
            <ForecastValue hour="07:00:00">2</ForecastValue>
            <ForecastValue hour="08:00:00">3</ForecastValue>
            <ForecastValue hour="09:00:00">4</ForecastValue>
            <ForecastValue hour="10:00:00">5</ForecastValue>
            <ForecastValue hour="11:00:00">6</ForecastValue>
            <ForecastValue hour="12:00:00">7</ForecastValue>
            <ForecastValue hour="13:00:00">8</ForecastValue>
            <ForecastValue hour="14:00:00">9</ForecastValue>
            <ForecastValue hour="15:00:00">10</ForecastValue>
            <ForecastValue hour="16:00:00">11</ForecastValue>
            <ForecastValue hour="17:00:00">12</ForecastValue>
            <ForecastValue hour="18:00:00">13</ForecastValue>
            <ForecastValue hour="19:00:00">14</ForecastValue>
            <ForecastValue hour="20:00:00">15</ForecastValue>
            <ForecastValue hour="21:00:00">16</ForecastValue>
            <ForecastValue hour="22:00:00">17</ForecastValue>
            <ForecastValue hour="23:00:00">18</ForecastValue>
          </ForecastValidationValues>
        </RetrieveResponseData>
      </WholesaleRetrieveResponse>
    </Transaction>
  </Transactions>
</ase:aseXML>
    
```

## 5.5.5 SetValidationValues

### 5.5.5.1 Description

The `setValidationValues()` method sets the demand forecast hourly validation values that can be optionally supplied by the participant during the WebExchanger registration process or at later stage via web services.

The values provide an upper limit (threshold) on the forecast values that can be entered by the participant at demand forecast submission, either through the web front end or via SOAP. If provided, any participant’s submission will be validated against those values.

The validation values can be defined for the system or a specific site.



Request Parameter:

Complex type	GasForecastValidationType
--------------	---------------------------

Request Attributes:

xsi:type	GasSubmitRequestData
context	ForecastValidation



Response Parameter:

Simple type	Xsd:boolean
-------------	-------------

Response Attributes:

xsi:type	GasSubmitResponseData
context	ForecastValidation

**Note 1:** `ForecastValues` in the request are business-mandatory. The `ForecastValues` provided will be used in the order where the first value is for 00:00 through to the last value for 23:00.

**Note 2:** If `SiteSpecific` is set to true, then a valid MIRN must be populated into the `NMI` element.

**Note 3:** If `SiteSpecific` is set to false, then any value provided in `NMI` will be ignored.

**Note 4:** If `applyTo` attribute is populated, its value will be ignored.

### 5.5.5.2 Input/Output Parameters

<b>Input Element</b>	GasSubmitRequestData
<b>Input Schema</b>	<pre> &lt;xsd:complexType name="GasSubmitRequestData"&gt;   &lt;xsd:complexContent&gt;     &lt;xsd:extension base="WholesaleSubmitRequestData"&gt;       &lt;xsd:choice&gt;         ...         &lt;xsd:element name="ForecastValidation"           type="GasForecastValidationType"/&gt;         ...       &lt;/xsd:choice&gt;       &lt;xsd:attribute name="version"         type="r31"         use="optional"         default="r31"/&gt;       &lt;xsd:attribute name="contextType"         type="GasSubmissionTransactionType"         use="required"/&gt;       &lt;xsd:attribute name="applyTo"         type="GasSubmissionType"         use="optional"/&gt;     &lt;/xsd:extension&gt;   &lt;/xsd:complexContent&gt; &lt;/xsd:complexType&gt;                 </pre>
<b>Output Element</b>	GasSubmitResponseData
<b>Output Schema</b>	<pre> &lt;xsd:complexType name="GasSubmitResponseData"&gt;   &lt;xsd:complexContent&gt;     &lt;xsd:extension base="WholesaleSubmitResponseData"&gt;       &lt;xsd:choice&gt;         ...         &lt;xsd:element name="Success" type="xsd:boolean"/&gt;         ...       &lt;/xsd:choice&gt;       &lt;xsd:attribute name="version"         type="r31"         use="optional"         default="r31"/&gt;     &lt;/xsd:extension&gt;   &lt;/xsd:complexContent&gt; &lt;/xsd:complexType&gt;                 </pre>



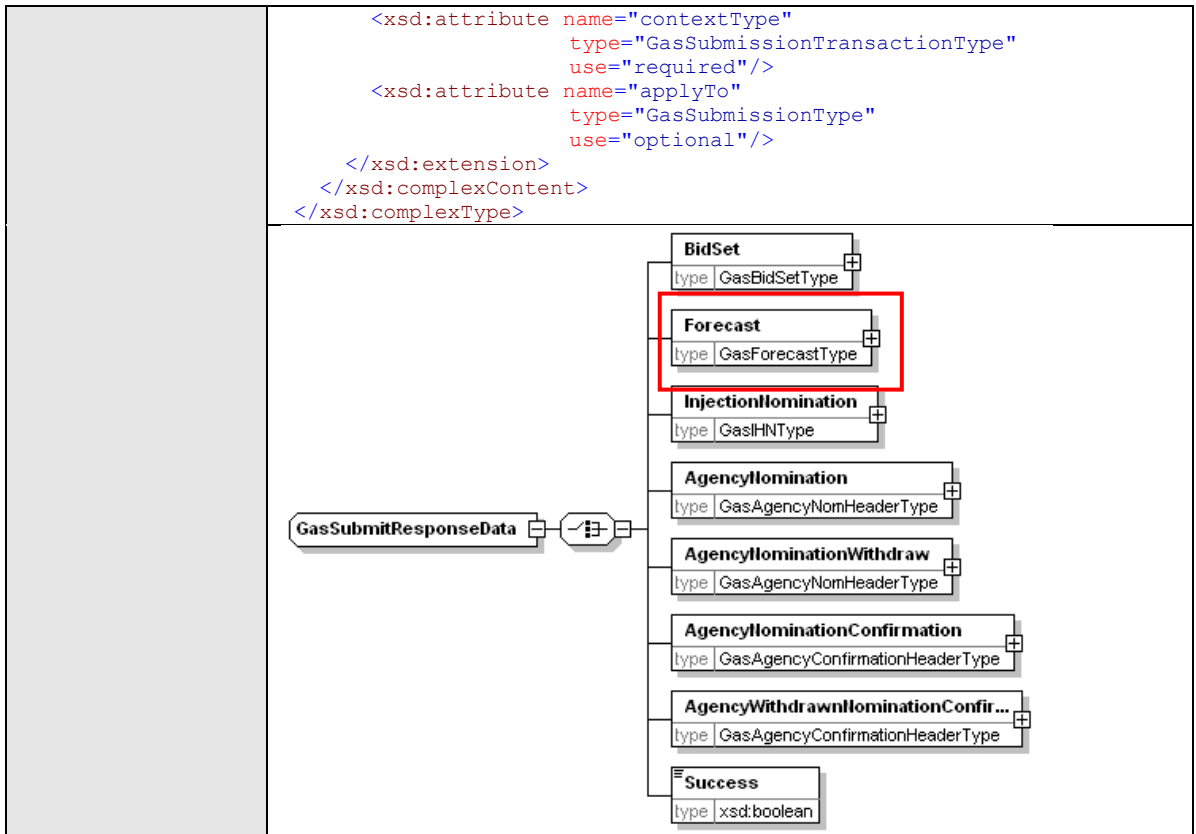

**5.5.5.3 SOAP Faults**

Fault Code	Fault Description
Global SOAP Faults	Refer to Global Fault Codes on page 61

### 5.5.5.4 Usage example

#### Request Sample

```

<ase:aseXML xmlns:ase="urn:aseXML:r31">
<Header>
  <From>VENCorp WebExchanger Participant</From>
  <To>VENCorp WebExchanger</To>
  <MessageID>C28A6C61-4BA8-A558-489B-C263229BA547</MessageID>
  <MessageDate>2006-03-17T10:57:40.278+10:00</MessageDate>
  <TransactionGroup>MKTW</TransactionGroup>
  <Priority>Medium</Priority>
  <Market>VICGAS</Market>
</Header>
<Transactions>
  <Transaction transactionID="C28A6C61-4BA8-A558-489B-C263229BA547"
    transactionDate="2006-03-17T10:57:40.278+10:00">
    <WholesaleSubmitRequest version="r20">
      <SubmitRequestData
        contextType="ForecastValidation"
        xsi:type="urn:GasSubmitRequestData"
        xmlns:urn="urn:aseXML:r31"
        xmlns:xsi="http://www.w3.org/2001/XMLSchema-instance">
        <ForecastValidation>
          <SpecificSite>>false</SpecificSite>
          <ValidationValues>
            <ForecastValue>1</ForecastValue>
            <ForecastValue>2</ForecastValue>
            <ForecastValue>3</ForecastValue>
            <ForecastValue>4</ForecastValue>
            <ForecastValue>5</ForecastValue>
            <ForecastValue>6</ForecastValue>
            <ForecastValue>7</ForecastValue>
            <ForecastValue>8</ForecastValue>
            <ForecastValue>9</ForecastValue>
            <ForecastValue>10</ForecastValue>
            <ForecastValue>11</ForecastValue>
            <ForecastValue>12</ForecastValue>
            <ForecastValue>13</ForecastValue>
            <ForecastValue>14</ForecastValue>
            <ForecastValue>15</ForecastValue>
            <ForecastValue>16</ForecastValue>
            <ForecastValue>17</ForecastValue>
            <ForecastValue>18</ForecastValue>
            <ForecastValue>19</ForecastValue>
            <ForecastValue>20</ForecastValue>
            <ForecastValue>21</ForecastValue>
            <ForecastValue>22</ForecastValue>
            <ForecastValue>23</ForecastValue>
            <ForecastValue>24</ForecastValue>
          </ValidationValues>
        </ForecastValidation>
      </SubmitRequestData>
    </WholesaleSubmitRequest>
  </Transaction>
</Transactions>
</ase:aseXML>

```

## Response Sample

```

<ase:aseXML xmlns:ase="urn:aseXML:r31">
<Header>
  <From>VENCorp WebExchanger</From>
  <To>VENCorp WebExchanger Recipient</To>
  <MessageID>69B0E69C-3A13-1107-00F1-090DEE70163B</MessageID>
  <MessageDate>2006-03-17T11:03:56.942+10:00</MessageDate>
  <TransactionGroup>MKTW</TransactionGroup>
  <Priority>Medium</Priority>
  <Market>VICGAS</Market>
</Header>
<Transactions>
  <Transaction transactionID="69B0E69C-3A13-1107-00F1-090DEE70163B"
    transactionDate="2006-03-17T11:03:56.942+10:00">
    <WholesaleSubmitResponse version="r20">
      <SubmitResponseData
        contextType="ForecastValidation"
        xsi:type="urn:GasSubmitResponseData"
        xmlns:urn="urn:aseXML:r31"
        xmlns:xsi="http://www.w3.org/2001/XMLSchema-instance">
        <Success>true</Success>
      </SubmitResponseData>
    </WholesaleSubmitResponse>
  </Transaction>
</Transactions>
</ase:aseXML>

```

## 5.5.6 SearchForecasts

### 5.5.6.1 Description

The `searchForecasts()` method searches for demand forecast information matching the criteria specified in the request message. The search can be based on:

- Start and end date
- Site specificity
- MIRN (if site specific; populated into `NMI` element)

The response message will contain zero or more matching demand forecast records.

Note 1: If `SiteSpecific` is set to true, then a valid MIRN must be populated into the `NMI` element.

Note 2: If `SiteSpecific` is set to false, then any value provided in `NMI` will be ignored.

Note 3: The `ForecastValues` retrieved will be in the order where the first value is for 00:00 through to the last value for 23:00.



Request Parameter:

Complex type	GasSearchRequestData
--------------	----------------------

Request Attributes:

xsi:type	GasForecastSearchType
context	Forecast



Response Parameter:

Complex type	GasSearchResponseData
--------------	-----------------------

Response Attributes:

xsi:type	GasForecastsType
context	Forecast

### 5.5.6.2 Input/Output Parameters

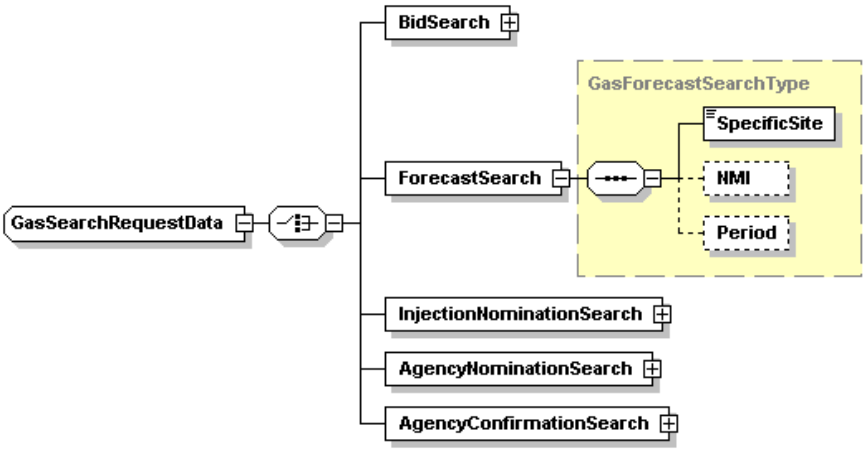
<b>Input Element</b>	GasSearchRequestData
<b>Input Schema</b>	<pre> &lt;xsd:complexType name="GasSearchRequestData"&gt;   &lt;xsd:complexContent&gt;     &lt;xsd:extension base="WholesaleSearchRequestData"&gt;       &lt;xsd:choice&gt;         ...         &lt;xsd:element name="ForecastSearch"           type="GasForecastSearchType"/&gt;         ...       &lt;/xsd:choice&gt;       &lt;xsd:attribute         name="version"         type="r30"         use="optional"         default="r30"/&gt;       &lt;xsd:attribute         name="contextType"         type="GasSearchTransactionType"         use="required"/&gt;     &lt;/xsd:extension&gt;   &lt;/xsd:complexContent&gt; &lt;/xsd:complexType&gt;                 </pre> 
<b>Output Element</b>	GasSearchResponseData
<b>Output Schema</b>	<pre> &lt;xsd:complexType name="GasSearchResponseData"&gt;   &lt;xsd:complexContent&gt;     &lt;xsd:extension base="WholesaleSearchResponseData"&gt;       &lt;xsd:choice&gt;         ...         &lt;xsd:element name="Forecasts" type="GasForecastsType"/&gt;         ...       &lt;/xsd:choice&gt;       &lt;xsd:attribute         name="version"         type="r31"         use="optional"         default="r31"/&gt;       &lt;xsd:attribute         name="contextType"         type="GasSearchTransactionType"         use="required"/&gt;     &lt;/xsd:extension&gt;   &lt;/xsd:complexContent&gt; &lt;/xsd:complexType&gt;                 </pre>

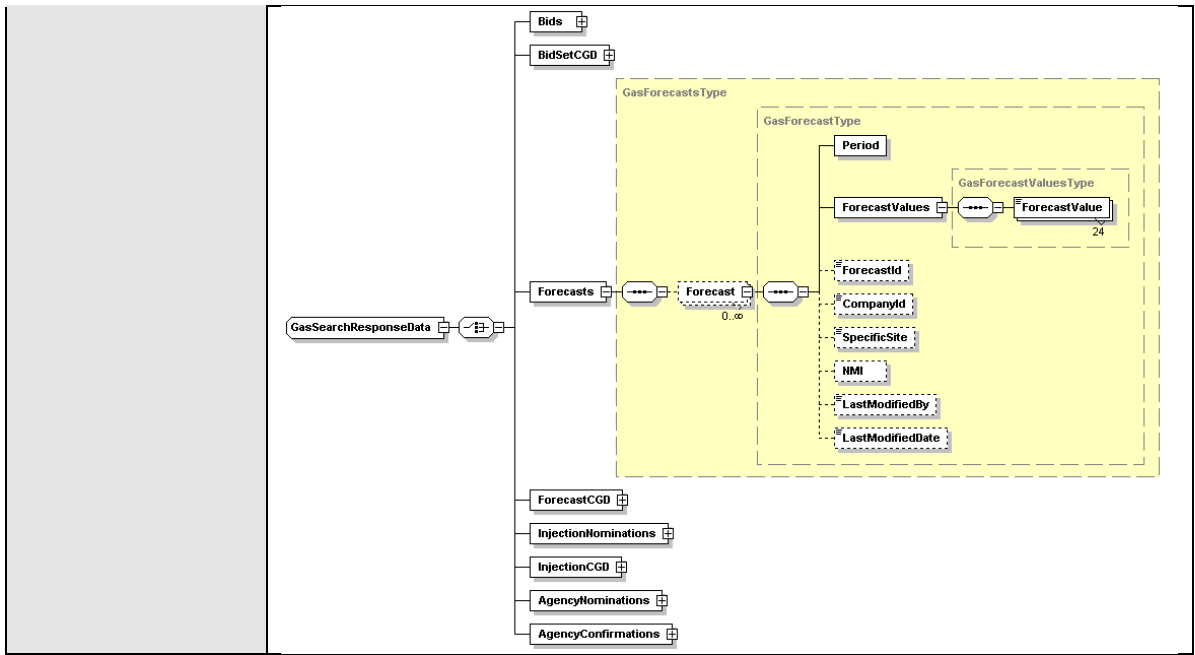

### 5.5.6.3 SOAP Faults

Fault Code	Fault Description
Global SOAP Faults	Refer to Global Fault Codes on page 61

### 5.5.6.4 Usage example

#### Request Sample

```
<ase:aseXML xmlns:ase="urn:aseXML:r31">
<Header>
<From>VENCORP WebExchanger Recipient</From>
<To>VENCORP WebExchanger</To>
<MessageID>29FB3124-3B1C-E01C-8426-430C2F97EA10</MessageID>
<MessageDate>2006-03-17T11:04:51.772+10:00</MessageDate>
<TransactionGroup>MKTW</TransactionGroup>
<Priority>Medium</Priority>
<Market>VICGAS</Market>
</Header>
<Transactions>
<Transaction transactionID="29FB3124-3B1C-E01C-8426-430C2F97EA10"
transactionDate="2006-03-17T11:04:51.772+10:00">
<WholesaleSearchRequest version="r20">
<SearchRequestData
contextType="Forecast"
xsi:type="urn:GasSearchRequestData"
xmlns:urn="urn:aseXML:r31"
xmlns:xsi="http://www.w3.org/2001/XMLSchema-instance">
<ForecastSearch>
<SpecificSite>true</SpecificSite>
<NMI>30000001PC</NMI>
<Period>
<BeginDate>2080-01-01+10:00</BeginDate>
<EndDate>2080-01-06+10:00</EndDate>
</Period>
</ForecastSearch>
</SearchRequestData>
</WholesaleSearchRequest>
</Transaction>
</Transactions>
</ase:aseXML>
```

#### Response Sample

```
<ase:aseXML xmlns:ase="urn:aseXML:r31">
<Header>
<From>VENCORP WebExchanger</From>
<To>VENCORP WebExchanger Recipient</To>
<MessageID>172A9AC1-8636-ED0A-E52B-BCEF3EDE0A12</MessageID>
<MessageDate>2006-03-17T11:04:55.795+10:00</MessageDate>
<TransactionGroup>MKTW</TransactionGroup>
<Priority>Medium</Priority>
<Market>VICGAS</Market>
</Header>
<Transactions>
<Transaction transactionID="172A9AC1-8636-ED0A-E52B-BCEF3EDE0A12"
transactionDate="2006-03-17T11:04:55.795+10:00">
<WholesaleSearchResponse version="r20">
<SearchResponseData
contextType="Forecast"
xsi:type="urn:GasSearchResponseData"
xmlns:urn="urn:aseXML:r31"
xmlns:xsi="http://www.w3.org/2001/XMLSchema-instance">
<Forecasts>
<Forecast>
<Period>
<BeginDate>2080-01-01+10:00</BeginDate>
<EndDate>2080-01-02+10:00</EndDate>
</Period>
<ForecastValues>
<ForecastValue>150</ForecastValue>
<ForecastValue>750</ForecastValue>
<ForecastValue>750</ForecastValue>
</ForecastValues>
</Forecast>
</Forecasts>
</SearchResponseData>
</WholesaleSearchResponse>
</Transaction>
</Transactions>
</ase:aseXML>
```

```

        <ForecastValue>750</ForecastValue>
        <ForecastValue>750</ForecastValue>
        <ForecastValue>750</ForecastValue>
        <ForecastValue>750</ForecastValue>
        <ForecastValue>350</ForecastValue>
        <ForecastValue>750</ForecastValue>
        <ForecastValue>450</ForecastValue>
        <ForecastValue>700</ForecastValue>
        <ForecastValue>750</ForecastValue>
        <ForecastValue>750</ForecastValue>
        <ForecastValue>750</ForecastValue>
        <ForecastValue>750</ForecastValue>
        <ForecastValue>750</ForecastValue>
        <ForecastValue>750</ForecastValue>
        <ForecastValue>750</ForecastValue>
        <ForecastValue>750</ForecastValue>
        <ForecastValue>750</ForecastValue>
        <ForecastValue>750</ForecastValue>
        <ForecastValue>750</ForecastValue>
        <ForecastValue>750</ForecastValue>
        <ForecastValue>750</ForecastValue>
        </ForecastValues>
        <ForecastId>10002</ForecastId>
        <CompanyId>10000</CompanyId>
        <SpecificSite>true</SpecificSite>
        <NMI>30000001PC</NMI>
        <LastModifiedBy>TEST</LastModifiedBy>
        <LastModifiedDate>2006-03-16T14:27:57.993+10:00</LastModifiedDate>
    </Forecast>
</Forecast>
<Forecast>
  <Period>
    <BeginDate>2080-01-03+10:00</BeginDate>
    <EndDate>2080-01-04+10:00</EndDate>
  </Period>
  <ForecastValues>
    <ForecastValue>150</ForecastValue>
    <ForecastValue>750</ForecastValue>
    <ForecastValue>750</ForecastValue>
    <ForecastValue>750</ForecastValue>
    <ForecastValue>750</ForecastValue>
    <ForecastValue>750</ForecastValue>
    <ForecastValue>750</ForecastValue>
    <ForecastValue>350</ForecastValue>
    <ForecastValue>750</ForecastValue>
    <ForecastValue>450</ForecastValue>
    <ForecastValue>700</ForecastValue>
    <ForecastValue>750</ForecastValue>
    <ForecastValue>750</ForecastValue>
    <ForecastValue>750</ForecastValue>
    <ForecastValue>750</ForecastValue>
    <ForecastValue>750</ForecastValue>
    <ForecastValue>750</ForecastValue>
    <ForecastValue>750</ForecastValue>
    <ForecastValue>750</ForecastValue>
    <ForecastValue>750</ForecastValue>
    <ForecastValue>750</ForecastValue>
    <ForecastValue>750</ForecastValue>
    <ForecastValue>750</ForecastValue>
    <ForecastValue>750</ForecastValue>
    <ForecastValue>750</ForecastValue>
    <ForecastValue>750</ForecastValue>
    </ForecastValues>
    <ForecastId>10003</ForecastId>
    <CompanyId>10000</CompanyId>
    <SpecificSite>true</SpecificSite>
    <NMI>30000001PC</NMI>
    <LastModifiedBy>TEST</LastModifiedBy>
    <LastModifiedDate>2006-03-16T14:27:57.993+10:00</LastModifiedDate>
  </Forecast>
</Forecasts>
</SearchResponseData>
</WholesaleSearchResponse>
</Transaction>
</Transactions>

```



```
</ase:aseXML>
```

## 5.5.7 SubmitForecast

### 5.5.7.1 Description

The `submitForecast()` method submits demand forecast information for processing by the WebExchanger application, using the supplied date range, MIRN (for site specific forecasts) and other information.

SOAP faults will be generated if the submission is not accepted for whatever reason. The possible SOAP faults are documented below along with the potential causes of the faults.



Request Parameter:

Complex type	GasSubmitRequestData
--------------	----------------------

Request Attributes:

xsi:type	GasForecastType
context	Forecast
applyTo	GasSubmissionType



Response Parameter:

Complex type	GasSubmitResponseData
--------------	-----------------------

Response Attributes:

xsi:type	GasForecastType
context	Forecast

Note 1: In submission request, elements `CompanyId`, and `ForecastId` will be ignored, if provided.

Note 2: In the request, if optional `applyTo` attribute is provided for current gas day, day ahead or two days ahead submission, then any values specified in the `Period` element will be ignored. The submission period will be automatically calculated by WebExchanger based on the current time. It is recommended that the `applyTo` attribute to be used for this type of the submission.

Note 3: In the request, if `applyTo` is set to "Standing", then the `Period` element must be populated with the correct values. The `Period's` `EndDate` (a.k.a. termination date) must be at least one day ahead of `BeginDate`. The `EndDate` is not inclusive.

Note 4: The ForecastValues provided will be used in the order where the first value is for 00:00 through to the last value for 23:00.

Note 5: If SiteSpecific is set to true, then a valid MIRN must be populated into the NMI element.

Note 6: If SiteSpecific is set to false, then any value provided in NMI will be ignored.

### 5.5.7.2 Input/Output Parameters

Input Element	GasSubmitRequestData
Input Schema	<pre> &lt;xsd:complexType name="GasSubmitRequestData"&gt;   &lt;xsd:complexContent&gt;     &lt;xsd:extension base="WholesaleSubmitRequestData"&gt;       &lt;xsd:choice&gt;         ...         &lt;xsd:element name="Forecast" type="GasForecastType"/&gt;         ...       &lt;/xsd:choice&gt;       &lt;xsd:attribute         name="version"         type="r31"         use="optional"         default="r31"/&gt;       &lt;xsd:attribute name="contextType"         type="GasSubmissionTransactionType"         use="required"/&gt;       &lt;xsd:attribute name="applyTo"         type="GasSubmissionType"         use="optional"/&gt;     &lt;/xsd:extension&gt;   &lt;/xsd:complexContent&gt; &lt;/xsd:complexType&gt; </pre>

<p><b>Output Element</b></p>	<p>GasSubmitResponseData</p>
<p><b>Output Schema</b></p>	<pre> &lt;xsd:complexType name="GasSubmitResponseData"&gt;   &lt;xsd:complexContent&gt;     &lt;xsd:extension base="WholesaleSubmitResponseData"&gt;       &lt;xsd:choice&gt;         ...         &lt;xsd:element name="Forecast" type="GasForecastType"/&gt;         ...       &lt;/xsd:choice&gt;       &lt;xsd:attribute         name="version"         type="r31"         use="optional"         default="r31"/&gt;       &lt;xsd:attribute         name="contextType"         type="GasSubmissionTransactionType"         use="required"/&gt;       &lt;xsd:attribute         name="applyTo"         type="GasSubmissionType"         use="optional"/&gt;     &lt;/xsd:extension&gt;   &lt;/xsd:complexContent&gt; </pre>

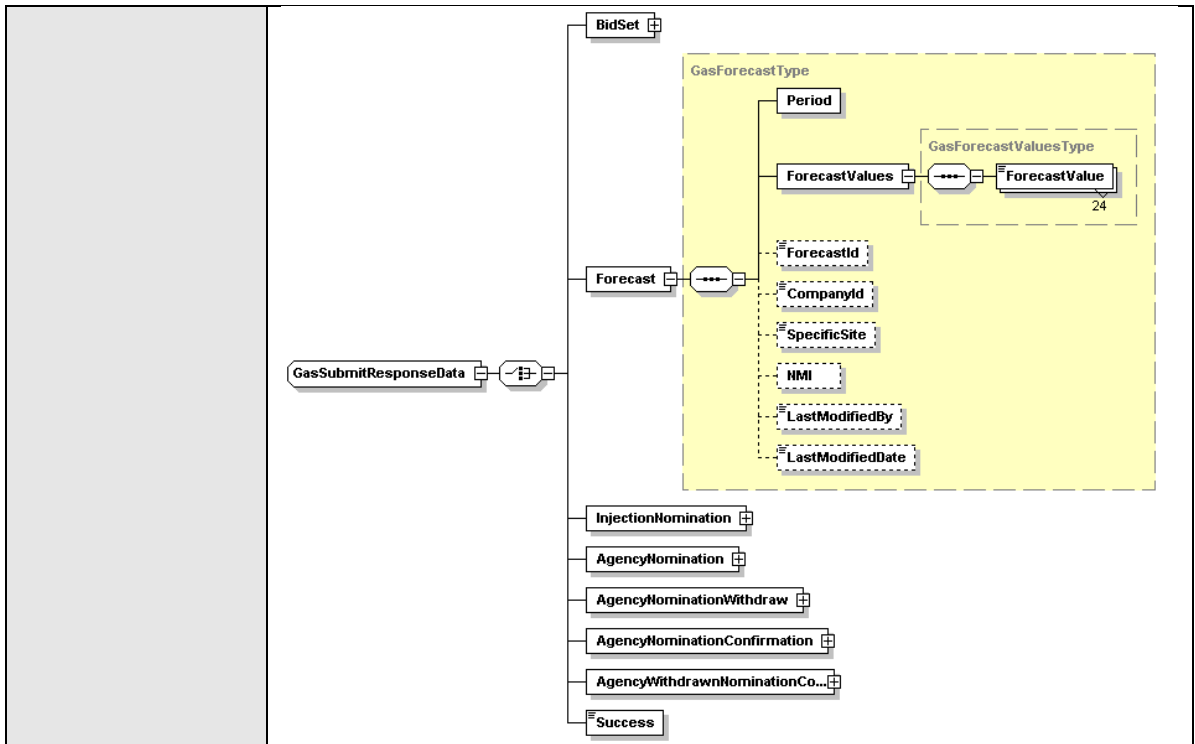

**5.5.7.3 SOAP Faults**

Fault Code	Fault Description
Global SOAP Faults	Refer to Global Fault Codes on page 61
3600	Demand forecast values are missing – not all of the forecast values have been supplied.
3601	Invalid validation values supplied – values must be $\geq 0$ .
3602	Invalid site supplied - meter must be supplied in the nmi element if the SiteSpecific element is set to true
3603	Invalid meter supplied – meter is not available to the corresponding market participant
3604	Invalid data value supplied - data value exceeds market participants constraint
3605	Invalid demand forecast - there is no standing forecasts or records for the current gas day
3606	Last interval cutoff has been passed. Forecast cannot be submitted at this time.

### 5.5.7.4 Usage example

Request Sample
<pre> &lt;ase:aseXML xmlns:ase="urn:aseXML:r31"&gt;   &lt;Header&gt;     &lt;From&gt;VENCorp WebExchanger Recipient&lt;/From&gt;     &lt;To&gt;TestTo&lt;/To&gt;     &lt;MessageID&gt;F2085344-1770-5732-05F7-446F3B31EEA1&lt;/MessageID&gt;     &lt;MessageDate&gt;2006-03-24T12:00:39.877+10:00&lt;/MessageDate&gt;     &lt;TransactionGroup&gt;MKTW&lt;/TransactionGroup&gt;     &lt;Priority&gt;Medium&lt;/Priority&gt;     &lt;Market&gt;VICGAS&lt;/Market&gt;   &lt;/Header&gt;   &lt;Transactions&gt;     &lt;Transaction transactionID="F2085344-1770-5732-05F7-446F3B31EEA1"       transactionDate="2006-03-24T12:00:39.877+10:00"&gt;       &lt;WholesaleSubmitRequest version="r20"&gt;         &lt;SubmitRequestData           applyTo="Current Day"           version="r31"           contextType="Forecast"           xsi:type="urn:GasSubmitRequestData"           xmlns:urn="urn:aseXML:r31"           xmlns:xsi="http://www.w3.org/2001/XMLSchema-instance"&gt;           &lt;Forecast&gt;             &lt;Period&gt;               &lt;BeginDate&gt;2007-06-01+10:00&lt;/BeginDate&gt;               &lt;EndDate&gt;2007-06-11+10:00&lt;/EndDate&gt;             &lt;/Period&gt;             &lt;ForecastValues&gt;               &lt;ForecastValue&gt;1&lt;/ForecastValue&gt;               &lt;ForecastValue&gt;2&lt;/ForecastValue&gt;               &lt;ForecastValue&gt;3&lt;/ForecastValue&gt;               &lt;ForecastValue&gt;4&lt;/ForecastValue&gt;               &lt;ForecastValue&gt;5&lt;/ForecastValue&gt;               &lt;ForecastValue&gt;6&lt;/ForecastValue&gt;               &lt;ForecastValue&gt;7&lt;/ForecastValue&gt;               &lt;ForecastValue&gt;8&lt;/ForecastValue&gt;               &lt;ForecastValue&gt;9&lt;/ForecastValue&gt;               &lt;ForecastValue&gt;10&lt;/ForecastValue&gt;               &lt;ForecastValue&gt;11&lt;/ForecastValue&gt;               &lt;ForecastValue&gt;12&lt;/ForecastValue&gt;               &lt;ForecastValue&gt;13&lt;/ForecastValue&gt;               &lt;ForecastValue&gt;14&lt;/ForecastValue&gt;               &lt;ForecastValue&gt;15&lt;/ForecastValue&gt;               &lt;ForecastValue&gt;16&lt;/ForecastValue&gt;               &lt;ForecastValue&gt;17&lt;/ForecastValue&gt;               &lt;ForecastValue&gt;18&lt;/ForecastValue&gt;               &lt;ForecastValue&gt;19&lt;/ForecastValue&gt;               &lt;ForecastValue&gt;20&lt;/ForecastValue&gt;               &lt;ForecastValue&gt;21&lt;/ForecastValue&gt;               &lt;ForecastValue&gt;22&lt;/ForecastValue&gt;               &lt;ForecastValue&gt;23&lt;/ForecastValue&gt;               &lt;ForecastValue&gt;24&lt;/ForecastValue&gt;             &lt;/ForecastValues&gt;           &lt;/Forecast&gt;         &lt;/SubmitRequestData&gt;       &lt;/WholesaleSubmitRequest&gt;     &lt;/Transaction&gt;   &lt;/Transactions&gt; &lt;/ase:aseXML&gt; </pre>

**Response Sample**

```

<ase:aseXML xmlns:ase="urn:aseXML:r31">
<Header>
  <From>VENCorp WebExchanger</From>
  <To>VENCorp WebExchanger Recipient</To>
  <MessageID>9323E5AE-322A-58F3-545F-3A134190D055</MessageID>
  <MessageDate>2006-03-24T14:35:52.769+10:00</MessageDate>
  <TransactionGroup>MKTW</TransactionGroup>
  <Priority>Medium</Priority>
  <Market>VICGAS</Market>
</Header>
<Transactions>
  <Transaction transactionID="9323E5AE-322A-58F3-545F-3A134190D055"
    transactionDate="2006-03-24T14:35:52.769+10:00">
    <WholesaleSubmitResponse version="r20">
      <SubmitResponseData
        contextType="Forecast"
        xsi:type="urn:GasSubmitResponseData"
        xmlns:urn="urn:aseXML:r31"
        xmlns:xsi="http://www.w3.org/2001/XMLSchema-instance">
        <Forecast>
          <Period>
            <BeginDate>2007-06-01+10:00</BeginDate>
            <EndDate>2007-06-11+10:00</EndDate>
          </Period>
          <ForecastValues>
            <ForecastValue>1</ForecastValue>
            <ForecastValue>2</ForecastValue>
            <ForecastValue>3</ForecastValue>
            <ForecastValue>4</ForecastValue>
            <ForecastValue>5</ForecastValue>
            <ForecastValue>6</ForecastValue>
            <ForecastValue>7</ForecastValue>
            <ForecastValue>8</ForecastValue>
            <ForecastValue>9</ForecastValue>
            <ForecastValue>10</ForecastValue>
            <ForecastValue>11</ForecastValue>
            <ForecastValue>12</ForecastValue>
            <ForecastValue>13</ForecastValue>
            <ForecastValue>14</ForecastValue>
            <ForecastValue>15</ForecastValue>
            <ForecastValue>16</ForecastValue>
            <ForecastValue>17</ForecastValue>
            <ForecastValue>18</ForecastValue>
            <ForecastValue>19</ForecastValue>
            <ForecastValue>20</ForecastValue>
            <ForecastValue>21</ForecastValue>
            <ForecastValue>22</ForecastValue>
            <ForecastValue>23</ForecastValue>
            <ForecastValue>24</ForecastValue>
          </ForecastValues>
          <ForecastId>50097</ForecastId>
          <CompanyId>10000</CompanyId>
          <SpecificSite>>false</SpecificSite>
          <LastModifiedBy>Wextest</LastModifiedBy>
          <LastModifiedDate>2006-03-24T14:35:52.769+10:00</LastModifiedDate>
        </Forecast>
      </SubmitResponseData>
    </WholesaleSubmitResponse>
  </Transaction>
</Transactions>
</ase:aseXML>
    
```

## 5.6 Web Service: Injection Hedge Nomination Service

### 5.6.1 Introduction

The Injection Hedge Nomination Service is responsible for all injection hedge nomination functionality, including retrieval of the historical data and submission of new injection hedge nominations to the WebExchanger application.

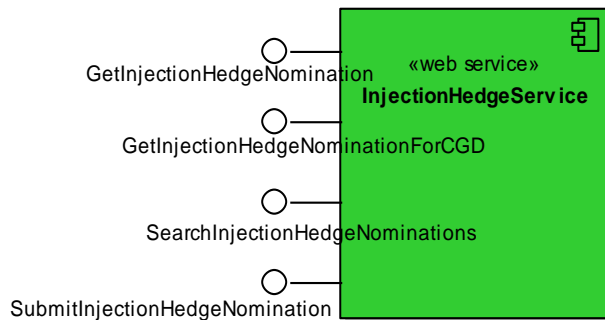

The service provide the following operations:

- GetInjectionHedgeNomination
- GetInjectionHedgeNominationForCGD
- SearchInjectionHedgeNominations
- SubmitInjectionHedgeNomination

### 5.6.2 GetInjectionHedgeNomination

#### 5.6.2.1 Description

The `getInjectionHedgeNomination()` method obtains all the data for a particular injection hedge nomination based on its identifier (Injection Nomination Header Id). Only nominations submitted by the logged in user, or another user within the same company/organization, will be viewable using this method.

Note, the number of entries returned in AMIQS element of the response will be equal to the number of scheduling intervals in a gas day.



Request Parameter:

Simple type	InjectionNominationHeaderId
-------------	-----------------------------

Request Attributes:

xsi:type	GasRetrieveRequestData
----------	------------------------



context	InjectionNomination
---------	---------------------



Response Parameter:

Complex type	GasIHNTType
--------------	-------------

Response Attributes:

xsi:type	GasRetrieveResponseData
context	InjectionNomination

### 5.6.2.2 Input/Output Parameters

Input Element	GasRetrieveRequestData
Input Schema	<pre> &lt;xsd:complexType name="GasRetrieveRequestData"&gt;   &lt;xsd:complexContent&gt;     &lt;xsd:extension base="WholesaleRetrieveRequestData"&gt;       &lt;xsd:choice&gt;         ...         &lt;xsd:element name="InjectionNominationHeaderId"           type="xsd:long"/&gt;         ...       &lt;/xsd:choice&gt;       &lt;xsd:attribute         name="version"         type="r30"         use="optional"         default="r30"/&gt;       &lt;xsd:attribute         name="contextType"         type="GasRetrieveTransactionType"         use="required"/&gt;     &lt;/xsd:extension&gt;   &lt;/xsd:complexContent&gt; &lt;/xsd:complexType&gt; </pre>

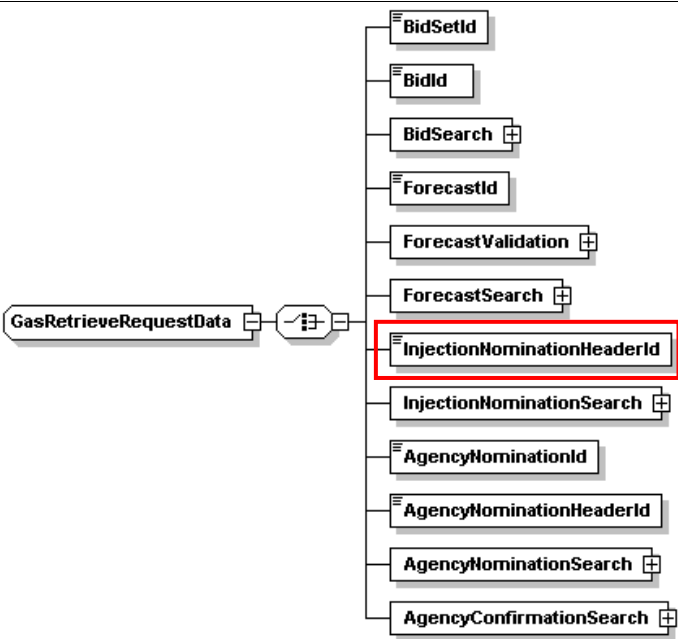
	
<b>Output Element</b>	GasRetrieveResponseData
	<pre> &lt;xsd:complexType name="GasRetrieveResponseData"&gt;   &lt;xsd:complexContent&gt;     &lt;xsd:extension base="WholesaleRetrieveResponseData"&gt;       &lt;xsd:sequence&gt;         &lt;xsd:choice&gt;           ...           &lt;xsd:element name="InjectionNomination" type="GasIHNTType"/&gt;           ...         &lt;/xsd:choice&gt;       &lt;/xsd:sequence&gt;     &lt;/xsd:extension&gt;   &lt;/xsd:complexContent&gt; &lt;/xsd:complexType&gt; </pre>

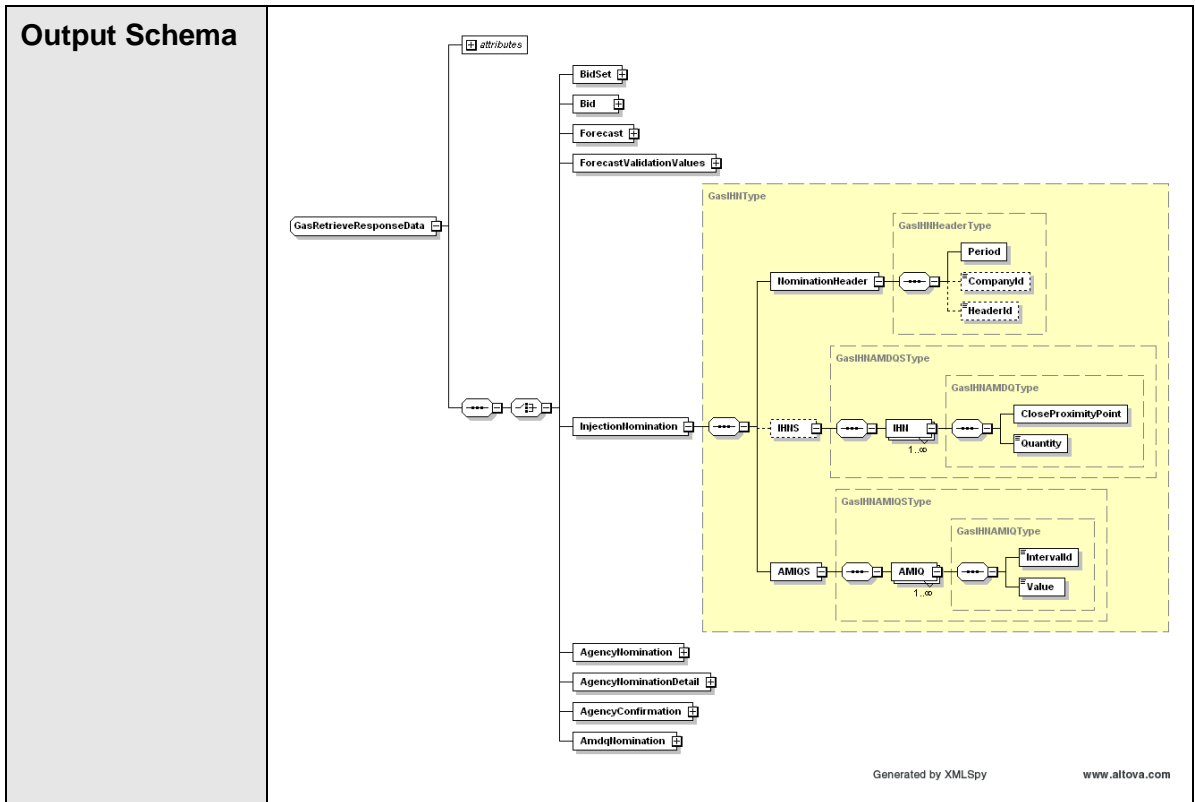

### 5.6.2.3 SOAP Faults

Fault Code	Fault Description
Global SOAP Faults	Refer to Global Fault Codes on page 61

### 5.6.2.4 Usage Examples

#### Request Sample

```
<ase:aseXML xmlns:ase="urn:aseXML:r31">
<Header>
  <From>VENC Corp WebExchanger Recipient</From>
  <To>VENC Corp WebExchanger</To>
  <MessageID>0FA49DA0-1FF0-CF91-89BD-A2ADFD17CCE8</MessageID>
  <MessageDate>2006-06-19T15:01:22.830+10:00</MessageDate>
  <TransactionGroup>MKTW</TransactionGroup>
  <Priority>Medium</Priority>
  <Market>VICGAS</Market>
</Header>
<Transactions>
  <Transaction transactionID="0FA49DA0-1FF0-CF91-89BD-A2ADFD17CCE8"
    transactionDate="2006-06-19T15:01:22.830+10:00">
    <WholesaleRetrieveRequest version="r20">
      <RetrieveRequestData
        contextType="InjectionNomination"
        xsi:type="urn:GasRetrieveRequestData"
        xmlns:urn="urn:aseXML:r31"
        xmlns:xsi="http://www.w3.org/2001/XMLSchema-instance">
        <InjectionNominationHeaderId>40099</InjectionNominationHeaderId>
      </RetrieveRequestData>
    </WholesaleRetrieveRequest>
  </Transaction>
</Transactions></ase:aseXML>
```

#### Response Sample 1 (with IHNS element)

```
<ase:aseXML xmlns:ase="urn:aseXML:r31">
<Header>
  <From>VENC Corp WebExchanger</From>
  <To>VENC Corp WebExchanger Recipient</To>
  <MessageID>812BC144-0AAB-A3BA-AB20-06998369AC11</MessageID>
  <MessageDate>2006-06-19T15:01:28.002+10:00</MessageDate>
  <TransactionGroup>MKTW</TransactionGroup>
  <Priority>Medium</Priority>
  <Market>VICGAS</Market>
</Header>
<Transactions>
  <Transaction transactionID="812BC144-0AAB-A3BA-AB20-06998369AC11"
    transactionDate="2006-06-19T15:01:28.002+10:00">
    <WholesaleRetrieveResponse version="r20">
      <RetrieveResponseData
        contextType="InjectionNomination"
        xsi:type="urn:GasRetrieveResponseData"
        xmlns:urn="urn:aseXML:r31"
        xmlns:xsi="http://www.w3.org/2001/XMLSchema-instance">
        <InjectionNomination>
          <NominationHeader>
            <Period>
              <BeginDate>2006-06-21+10:00</BeginDate>
              <EndDate>2006-06-22+10:00</EndDate>
            </Period>
            <CompanyId>5</CompanyId>
            <HeaderId>40099</HeaderId>
          </NominationHeader>
          <IHNS>
            <IHN>
              <CloseProximityPoint>30000001PC</CloseProximityPoint>
              <Quantity>2000</Quantity>
            </IHN>
          </IHNS>
          <AMIQS>
            <AMIQ>
              <IntervalId>1</IntervalId>
              <Value>10.0</Value>
            </AMIQ>
          </AMIQS>
        </InjectionNomination>
      </RetrieveResponseData>
    </WholesaleRetrieveResponse>
  </Transaction>
</Transactions></ase:aseXML>
```

```

        <AMIQ>
          <IntervalId>2</IntervalId>
          <Value>10.0</Value>
        </AMIQ>
        <AMIQ>
          <IntervalId>3</IntervalId>
          <Value>0.0</Value>
        </AMIQ>
        <AMIQ>
          <IntervalId>4</IntervalId>
          <Value>0.0</Value>
        </AMIQ>
        <AMIQ>
          <IntervalId>5</IntervalId>
          <Value>0.0</Value>
        </AMIQ>
      </AMIQS>
    </InjectionNomination>
  </RetrieveResponseData>
</WholesaleRetrieveResponse>
</Transaction>
</Transactions>
</ase:aseXML>
    
```

**Response Sample 2 (without IHNS element)**

```

<ase:aseXML xmlns:ase="urn:aseXML:r31">
  <Header>
    <From>VENCorp WebExchanger</From>
    <To>VENCorp WebExchanger Recipient</To>
    <MessageID>812BC144-0AAB-A3BA-AB20-06998369AC11</MessageID>
    <MessageDate>2006-06-19T15:01:28.002+10:00</MessageDate>
    <TransactionGroup>MKTW</TransactionGroup>
    <Priority>Medium</Priority>
    <Market>VICGAS</Market>
  </Header>
  <Transactions>
    <Transaction transactionID="812BC144-0AAB-A3BA-AB20-06998369AC11"
      transactionDate="2006-06-19T15:01:28.002+10:00">
      <WholesaleRetrieveResponse version="r20">
        <RetrieveResponseData
          contextType="InjectionNomination"
          xsi:type="urn:GasRetrieveResponseData"
          xmlns:urn="urn:aseXML:r31"
          xmlns:xsi="http://www.w3.org/2001/XMLSchema-instance">
          <InjectionNomination>
            <NominationHeader>
              <Period>
                <BeginDate>2006-06-21+10:00</BeginDate>
                <EndDate>2006-06-22+10:00</EndDate>
              </Period>
              <CompanyId>5</CompanyId>
              <HeaderId>40099</HeaderId>
            </NominationHeader>
            <AMIQS>
              <AMIQ>
                <IntervalId>1</IntervalId>
                <Value>10.0</Value>
              </AMIQ>
              <AMIQ>
                <IntervalId>2</IntervalId>
                <Value>10.0</Value>
              </AMIQ>
              <AMIQ>
                <IntervalId>3</IntervalId>
                <Value>0.0</Value>
              </AMIQ>
              <AMIQ>
                <IntervalId>4</IntervalId>
                <Value>0.0</Value>
              </AMIQ>
            </AMIQS>
          </InjectionNomination>
        </RetrieveResponseData>
      </WholesaleRetrieveResponse>
    </Transaction>
  </Transactions>
</ase:aseXML>
    
```

```
<AMIQ>  
  <IntervalId>5</IntervalId>  
  <Value>0.0</Value>  
</AMIQ>  
</AMIQS>  
</InjectionNomination>  
</RetrieveResponseData>  
</WholesaleRetrieveResponse>  
</Transaction>  
</Transactions>  
</ase:aseXML>
```

### 5.6.3 GetInjectionHedgeNominationForCGD

#### 5.6.3.1 Description

The `getInjectionHedgeNominationForCGD()` method returns the injection hedge nomination that is effective for the current gas day. Only nominations submitted by the logged in user, or another user within the same company/organization, will be viewable using this method.

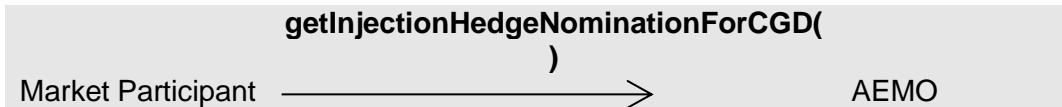

Request Parameter:

Complex type	InjectionNominationSearch
--------------	---------------------------

Request Attributes:

xsi:type	GasRetrieveRequestData
context	InjectionNominationCGD



Response Parameter:

Complex type	GasIHNTType
--------------	-------------

Response Attributes:

xsi:type	GasRetrieveResponseData
context	InjectionNominationCGD

Note 1: In a request, if `Period` element is supplied, then it will be ignored.

Note 2: In a response, `IntervalId` with value of 1 corresponds to the first scheduling interval with published time of 6:00am.

#### 5.6.3.2 Input/Output Parameters

<b>Input Element</b>	GasRetrieveRequestData
<b>Input Schema</b>	<pre> &lt;xsd:complexType name="GasRetrieveRequestData"&gt;   &lt;xsd:complexContent&gt;     &lt;xsd:extension base="WholesaleRetrieveRequestData"&gt;       &lt;xsd:choice&gt;         ...         &lt;xsd:element           name="InjectionNominationSearch"           type="GasInjectionNominationSearchType"/&gt;         ...       </pre>

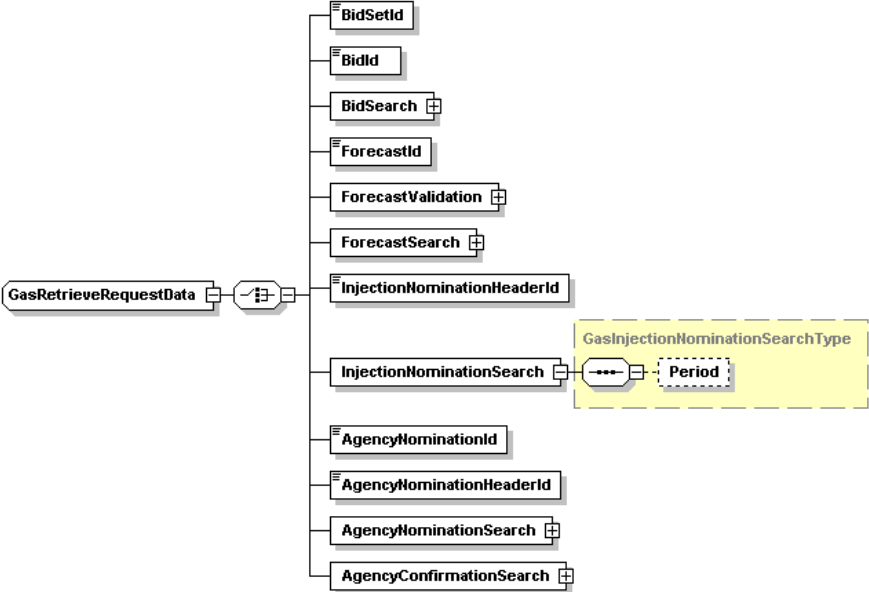
	<pre> &lt;/xsd:choice&gt; &lt;xsd:attribute   name="version"   type="r30"   use="optional"   default="r30"/&gt; &lt;xsd:attribute   name="contextType"   type="GasRetrieveTransactionType"   use="required"/&gt; &lt;/xsd:extension&gt; &lt;/xsd:complexContent&gt; &lt;/xsd:complexType&gt;         </pre> 
<p><b>Output Element</b></p>	<p><b>GasRetrieveResponseData</b></p> <pre> &lt;xsd:complexType name="GasRetrieveResponseData"&gt;   &lt;xsd:complexContent&gt;     &lt;xsd:extension base="WholesaleRetrieveResponseData"&gt;       &lt;xsd:sequence&gt;         &lt;xsd:choice&gt;           ...           &lt;xsd:element name="InjectionNomination" type="GasIHNTType"/&gt;           ...         &lt;/xsd:choice&gt;       &lt;/xsd:sequence&gt;     &lt;/xsd:extension&gt;   &lt;/xsd:complexContent&gt; &lt;/xsd:complexType&gt;         </pre>



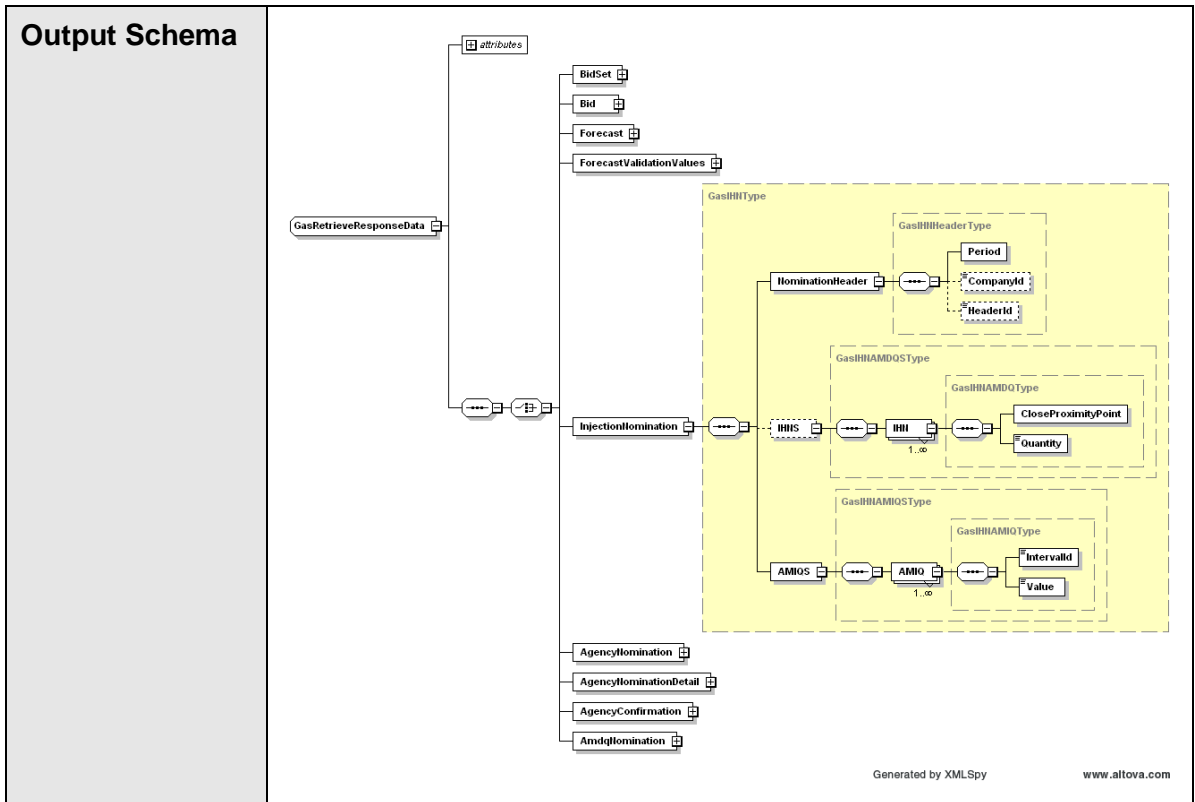

### 5.6.3.3 SOAP Faults

Fault Code	Fault Description
Global SOAP Faults	Refer to Global Fault Codes on page 61

### 5.6.3.4 Usage Examples

#### Request Sample

```
<ase:aseXML xmlns:ase="urn:aseXML:r31">
  <Header>
    <From>VENCorp WebExchanger Recipient</From>
    <To>VENCorp WebExchanger</To>
    <MessageID>9EA023B0-D0AF-6D1E-C0AA-5AC42C15329A</MessageID>
    <MessageDate>2006-06-19T16:45:16.040+10:00</MessageDate>
    <TransactionGroup>MKTW</TransactionGroup>
    <Priority>Medium</Priority>
    <Market>VICGAS</Market>
  </Header>
  <Transactions>
    <Transaction transactionID="9EA023B0-D0AF-6D1E-C0AA-5AC42C15329A"
      transactionDate="2006-06-19T16:45:16.040+10:00">
      <WholesaleRetrieveRequest version="r20">
        <RetrieveRequestData
          contextType="InjectionNominationCGD"
          xsi:type="urn:GasRetrieveRequestData"
          xmlns:urn="urn:aseXML:r31"
          xmlns:xsi="http://www.w3.org/2001/XMLSchema-instance">
          <InjectionNominationSearch/>
        </RetrieveRequestData>
      </WholesaleRetrieveRequest>
    </Transaction>
  </Transactions>
</ase:aseXML>
```

#### Response Sample 1 (with IHNS element)

```
<ase:aseXML xmlns:ase="urn:aseXML:r31">
  <Header>
    <From>VENCorp WebExchanger</From>
    <To>VENCorp WebExchanger Recipient</To>
    <MessageID>94243EF6-AE93-DA1C-3183-1FD6307301A4</MessageID>
    <MessageDate>2006-06-19T16:45:29.681+10:00</MessageDate>
    <TransactionGroup>MKTW</TransactionGroup>
    <Priority>Medium</Priority>
    <Market>VICGAS</Market>
  </Header>
  <Transactions>
    <Transaction transactionID="94243EF6-AE93-DA1C-3183-1FD6307301A4"
      transactionDate="2006-06-19T16:45:29.681+10:00">
      <WholesaleRetrieveResponse version="r20">
        <RetrieveResponseData
          contextType="InjectionNominationCGD"
          xsi:type="urn:GasRetrieveResponseData"
          xmlns:urn="urn:aseXML:r31"
          xmlns:xsi="http://www.w3.org/2001/XMLSchema-instance">
          <InjectionNomination>
            <NominationHeader>
              <Period>
                <BeginDate>2006-06-15+10:00</BeginDate>
                <EndDate>2006-06-21+10:00</EndDate>
              </Period>
              <CompanyId>5</CompanyId>
              <HeaderId>40093</HeaderId>
            </NominationHeader>
            <IHNS>
              <IHN>
                <CloseProximityPoint>30000001PC</CloseProximityPoint>
                <Quantity>2000</Quantity>
              </IHN>
            </IHNS>
            <AMIQS>
              <AMIQ>
                <IntervalId>1</IntervalId>
              </AMIQ>
            </AMIQS>
          </InjectionNomination>
        </RetrieveResponseData>
      </WholesaleRetrieveResponse>
    </Transaction>
  </Transactions>
</ase:aseXML>
```

```

        <Value>20.0</Value>
    </AMIQ>
    <AMIQ>
        <IntervalId>2</IntervalId>
        <Value>20.0</Value>
    </AMIQ>
    <AMIQ>
        <IntervalId>3</IntervalId>
        <Value>20.0</Value>
    </AMIQ>
    <AMIQ>
        <IntervalId>4</IntervalId>
        <Value>0.0</Value>
    </AMIQ>
    <AMIQ>
        <IntervalId>5</IntervalId>
        <Value>0.0</Value>
    </AMIQ>
</AMIQS>
</InjectionNomination>
</RetrieveResponseData>
</WholesaleRetrieveResponse>
</Transaction>
</Transactions>
</ase:aseXML>
    
```

**Response Sample (without IHNS element)**

```

<ase:aseXML xmlns:ase="urn:aseXML:r31">
<Header>
    <From>VENCorp WebExchanger</From>
    <To>VENCorp WebExchanger Recipient</To>
    <MessageID>94243EF6-AE93-DA1C-3183-1FD6307301A4</MessageID>
    <MessageDate>2006-06-19T16:45:29.681+10:00</MessageDate>
    <TransactionGroup>MKTW</TransactionGroup>
    <Priority>Medium</Priority>
    <Market>VICGAS</Market>
</Header>
<Transactions>
    <Transaction transactionID="94243EF6-AE93-DA1C-3183-1FD6307301A4"
        transactionDate="2006-06-19T16:45:29.681+10:00">
        <WholesaleRetrieveResponse version="r20">
            <RetrieveResponseData
                contextType="InjectionNominationCGD"
                xsi:type="urn:GasRetrieveResponseData"
                xmlns:urn="urn:aseXML:r31"
                xmlns:xsi="http://www.w3.org/2001/XMLSchema-instance">
                <InjectionNomination>
                    <NominationHeader>
                        <Period>
                            <BeginDate>2006-06-15+10:00</BeginDate>
                            <EndDate>2006-06-21+10:00</EndDate>
                        </Period>
                        <CompanyId>5</CompanyId>
                        <HeaderId>40093</HeaderId>
                    </NominationHeader>
                    <AMIQS>
                        <AMIQ>
                            <IntervalId>1</IntervalId>
                            <Value>20.0</Value>
                        </AMIQ>
                        <AMIQ>
                            <IntervalId>2</IntervalId>
                            <Value>20.0</Value>
                        </AMIQ>
                        <AMIQ>
                            <IntervalId>3</IntervalId>
                            <Value>20.0</Value>
                        </AMIQ>
                        <AMIQ>
                            <IntervalId>4</IntervalId>
                            <Value>0.0</Value>
                        </AMIQ>
                    </AMIQS>
                </RetrieveResponseData>
            </WholesaleRetrieveResponse>
        </Transaction>
    </Transactions>
</ase:aseXML>
    
```

```
</AMIQ>
<AMIQ>
  <IntervalId>5</IntervalId>
  <Value>0.0</Value>
</AMIQ>
</AMIQS>
</InjectionNomination>
</RetrieveResponseData>
</WholesaleRetrieveResponse>
</Transaction>
</Transactions>
</ase:aseXML>
```

## 5.6.4 SearchInjectionHedgeNominations

### 5.6.4.1 Description

The `searchInjectionHedgeNominations()` operation is responsible for the retrieval of injection hedge nominations that fall into specified period. This operation will return data if:

- There is a nomination – either standing or for individual gas day, and
- The date range provided in the parameter is either completely enclosed in the above standing nomination, or
- Period’s termination date is after than the nomination’s commencement date, or
- Period’s commencement date is before the nomination’s termination date.

Only nominations submitted by the logged in user, or another user within the same company/organization, will be viewable using this method.

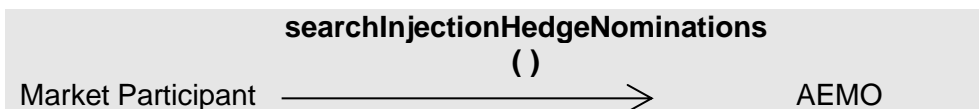

Request Parameter:

Complex type	GasInjectionNominationSearchType
--------------	----------------------------------

Request Attributes:

xsi:type	GasSearchRequestData
context	InjectionNomination



Response Parameter:

Complex type	GasInjectionNominationsType
--------------	-----------------------------

Response Attributes:

xsi:type	GasSearchResponseData
context	InjectionNomination

### 5.6.4.2 Input/Output Parameters

<b>Input Element</b>	GasSearchRequestData
----------------------	----------------------

<p><b>Input Schema</b></p>	<pre> &lt;xsd:complexType name="GasSearchRequestData"&gt;   &lt;xsd:complexContent&gt;     &lt;xsd:extension base="WholesaleSearchRequestData"&gt;       &lt;xsd:choice&gt;         ...         &lt;xsd:element           name="InjectionNominationSearch"           type="GasInjectionNominationSearchType"/&gt;         ...       &lt;/xsd:choice&gt;       &lt;xsd:attribute         name="version"         type="r30"         use="optional"         default="r30"/&gt;       &lt;xsd:attribute         name="contextType"         type="GasSearchTransactionType"         use="required"/&gt;     &lt;/xsd:extension&gt;   &lt;/xsd:complexContent&gt; &lt;/xsd:complexType&gt; </pre>
<p><b>Output Element</b></p>	<p>GasSearchResponseData</p> <pre> &lt;xsd:complexType name="GasSearchResponseData"&gt;   &lt;xsd:complexContent&gt;     &lt;xsd:extension base="WholesaleSearchResponseData"&gt;       &lt;xsd:choice&gt;         ...         &lt;xsd:element           name="InjectionNominations"           type="GasInjectionNominationsType"/&gt;         ...       &lt;/xsd:choice&gt;       &lt;xsd:attribute         name="version"         type="r31"         use="optional"         default="r31"/&gt;       &lt;xsd:attribute         name="contextType"         type="GasSearchTransactionType"         use="required"/&gt;     &lt;/xsd:extension&gt;   &lt;/xsd:complexContent&gt; &lt;/xsd:complexType&gt; </pre>
<p><b>Output Schema</b></p>	

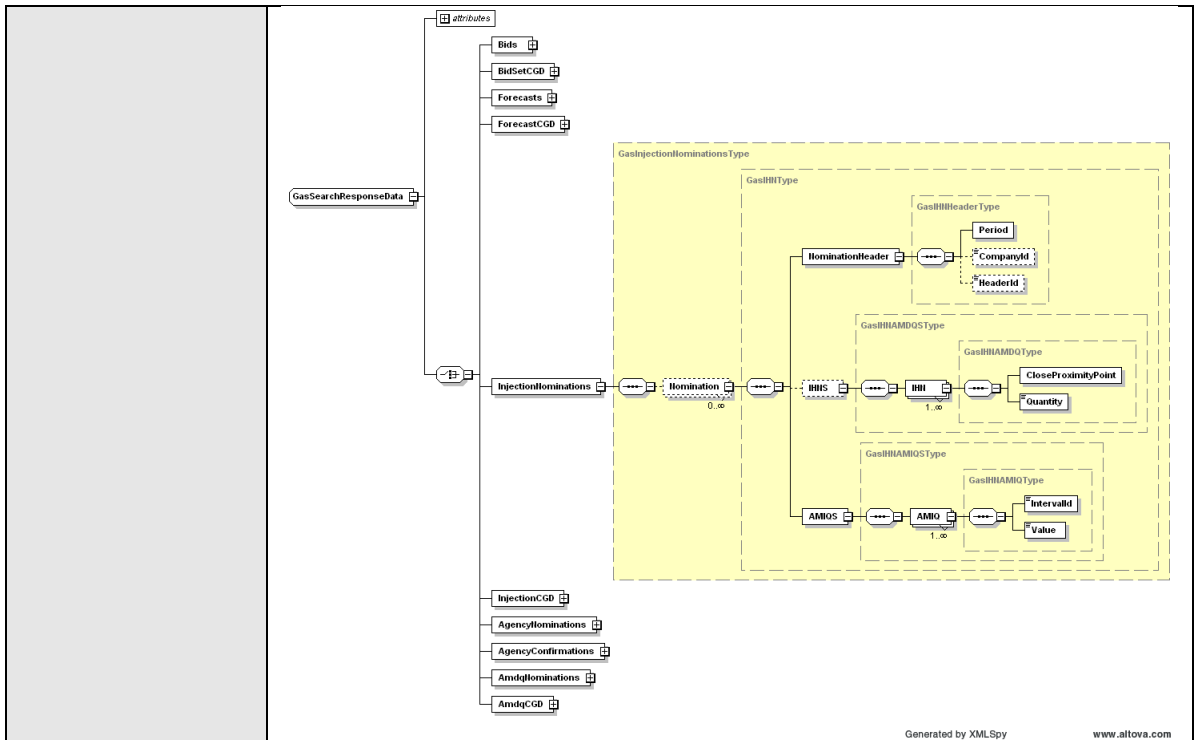

### 5.6.4.3 SOAP Faults

Fault Code	Fault Description
Global SOAP Faults	Refer to Global Fault Codes on page 61

### 5.6.4.4 Usage Examples

```

Request Sample
<ase:aseXML xmlns:ase="urn:aseXML:r31">
  <Header>
    <From>VENCorp WebExchanger Recipient</From>
    <To>VENCorp WebExchanger</To>
    <MessageID>957EC009-0C4F-26B8-6CB4-F056AF68BBAA</MessageID>
    <MessageDate>2006-06-19T14:55:21.098+10:00</MessageDate>
    <TransactionGroup>MKTW</TransactionGroup>
    <Priority>Medium</Priority>
    <Market>VICGAS</Market>
  </Header>
  <Transactions>
    <Transaction transactionID="957EC009-0C4F-26B8-6CB4-F056AF68BBAA"
      transactionDate="2006-06-19T14:55:21.098+10:00">
      <WholesaleSearchRequest version="r20">
        <SearchRequestData contextType="InjectionNomination"
          xsi:type="urn:GasSearchRequestData"
          xmlns:urn="urn:aseXML:r31"
          xmlns:xsi="http://www.w3.org/2001/XMLSchema-instance">
          <InjectionNominationSearch>
            <Period>
              <BeginDate>2006-06-19+10:00</BeginDate>
              <EndDate>2006-06-23+10:00</EndDate>
            </Period>
          </SearchRequestData>
        </WholesaleSearchRequest>
      </Transaction>
    </Transactions>
  </ase:aseXML>
    
```

```

        </InjectionNominationSearch>
    </SearchRequestData>
</WholesaleSearchRequest>
</Transaction>
</Transactions>
</ase:aseXML>
    
```

**Response Sample 1 (with IHNS element)**

```

<ase:aseXML xmlns:ase="urn:aseXML:r31">
  <Header>
    <From>VENCorp WebExchanger</From>
    <To>VENCorp WebExchanger Recipient</To>
    <MessageID>64380B73-DBC4-F97C-8B0E-D8E09214A298</MessageID>
    <MessageDate>2006-06-19T14:55:35.676+10:00</MessageDate>
    <TransactionGroup>MKTW</TransactionGroup>
    <Priority>Medium</Priority>
    <Market>VICGAS</Market>
  </Header>
  <Transactions>
    <Transaction transactionID="64380B73-DBC4-F97C-8B0E-D8E09214A298"
      transactionDate="2006-06-19T14:55:35.676+10:00">
      <WholesaleSearchResponse version="r20">
        <SearchResponseData
          contextType="InjectionNomination"
          xsi:type="urn:GasSearchResponseData"
          xmlns:urn="urn:aseXML:r31"
          xmlns:xsi="http://www.w3.org/2001/XMLSchema-instance">
          <InjectionNominations>
            <Nomination>
              <NominationHeader>
                <Period>
                  <BeginDate>2006-06-15+10:00</BeginDate>
                  <EndDate>2006-06-21+10:00</EndDate>
                </Period>
                <CompanyId>5</CompanyId>
                <HeaderId>40093</HeaderId>
              </NominationHeader>
              <IHNS>
                <IHN>
                  <CloseProximityPoint>30000001PC</CloseProximityPoint>
                  <Quantity>2000</Quantity>
                </IHN>
              </IHNS>
              <AMIQS>
                <AMIQ>
                  <IntervalId>1</IntervalId>
                  <Value>20.0</Value>
                </AMIQ>
                <AMIQ>
                  <IntervalId>2</IntervalId>
                  <Value>20.0</Value>
                </AMIQ>
                <AMIQ>
                  <IntervalId>3</IntervalId>
                  <Value>20.0</Value>
                </AMIQ>
                <AMIQ>
                  <IntervalId>4</IntervalId>
                  <Value>20.0</Value>
                </AMIQ>
                <AMIQ>
                  <IntervalId>5</IntervalId>
                  <Value>20.0</Value>
                </AMIQ>
              </AMIQS>
            </Nomination>
            <Nomination>
              <NominationHeader>
                <Period>
    
```



```

        <BeginDate>2006-06-21+10:00</BeginDate>
        <EndDate>2006-06-22+10:00</EndDate>
    </Period>
    <CompanyId>5</CompanyId>
    <HeaderId>40099</HeaderId>
</NominationHeader>
<IHNS>
    <IHN>
        <CloseProximityPoint>30000001PC</CloseProximityPoint>
        <Quantity>2000</Quantity>
    </IHN>
</IHNS>
<AMIQS>
    <AMIQ>
        <IntervalId>1</IntervalId>
        <Value>10.0</Value>
    </AMIQ>
    <AMIQ>
        <IntervalId>2</IntervalId>
        <Value>20.0</Value>
    </AMIQ>
    <AMIQ>
        <IntervalId>3</IntervalId>
        <Value>10.0</Value>
    </AMIQ>
    <AMIQ>
        <IntervalId>4</IntervalId>
        <Value>15.5</Value>
    </AMIQ>
    <AMIQ>
        <IntervalId>5</IntervalId>
        <Value>10.0</Value>
    </AMIQ>
</AMIQS>
</Nomination>
<Nomination>
    <NominationHeader>
        <Period>
            <BeginDate>2006-06-22+10:00</BeginDate>
            <EndDate>2006-07-31+10:00</EndDate>
        </Period>
        <CompanyId>5</CompanyId>
        <HeaderId>40098</HeaderId>
    </NominationHeader>
    <IHNS>
        <IHN>
            <CloseProximityPoint>30000001PC</CloseProximityPoint>
            <Quantity>1450</Quantity>
        </IHN>
    </IHNS>
    <AMIQS>
        <AMIQ>
            <IntervalId>1</IntervalId>
            <Value>25.0</Value>
        </AMIQ>
        <AMIQ>
            <IntervalId>2</IntervalId>
            <Value>10.3</Value>
        </AMIQ>
        <AMIQ>
            <IntervalId>3</IntervalId>
            <Value>10.0</Value>
        </AMIQ>
        <AMIQ>
            <IntervalId>4</IntervalId>
            <Value>5.9</Value>
        </AMIQ>
        <AMIQ>
            <IntervalId>5</IntervalId>
            <Value>0.0</Value>
        </AMIQ>
    </AMIQS>

```

```

        </Nomination>
    </InjectionNominations>
</SearchResponseData>
</WholesaleSearchResponse>
</Transaction>
</Transactions>
</ase:aseXML>
    
```

**Response Sample 2 (without IHNS element)**

```

<ase:aseXML xmlns:ase="urn:aseXML:r31">
  <Header>
    <From>VENCorp WebExchanger</From>
    <To>VENCorp WebExchanger Recipient</To>
    <MessageID>64380B73-DBC4-F97C-8B0E-D8E09214A298</MessageID>
    <MessageDate>2006-06-19T14:55:35.676+10:00</MessageDate>
    <TransactionGroup>MKTW</TransactionGroup>
    <Priority>Medium</Priority>
    <Market>VICGAS</Market>
  </Header>
  <Transactions>
    <Transaction transactionID="64380B73-DBC4-F97C-8B0E-D8E09214A298"
      transactionDate="2006-06-19T14:55:35.676+10:00">
      <WholesaleSearchResponse version="r20">
        <SearchResponseData
          contextType="InjectionNomination"
          xsi:type="urn:GasSearchResponseData"
          xmlns:urn="urn:aseXML:r31"
          xmlns:xsi="http://www.w3.org/2001/XMLSchema-instance">
          <InjectionNominations>
            <Nomination>
              <NominationHeader>
                <Period>
                  <BeginDate>2006-06-15+10:00</BeginDate>
                  <EndDate>2006-06-21+10:00</EndDate>
                </Period>
                <CompanyId>5</CompanyId>
                <HeaderId>40093</HeaderId>
              </NominationHeader>
              <AMIQS>
                <AMIQ>
                  <IntervalId>1</IntervalId>
                  <Value>20.0</Value>
                </AMIQ>
                <AMIQ>
                  <IntervalId>2</IntervalId>
                  <Value>20.0</Value>
                </AMIQ>
                <AMIQ>
                  <IntervalId>3</IntervalId>
                  <Value>20.0</Value>
                </AMIQ>
                <AMIQ>
                  <IntervalId>4</IntervalId>
                  <Value>20.0</Value>
                </AMIQ>
                <AMIQ>
                  <IntervalId>5</IntervalId>
                  <Value>20.0</Value>
                </AMIQ>
              </AMIQS>
            </Nomination>
            <Nomination>
              <NominationHeader>
                <Period>
                  <BeginDate>2006-06-21+10:00</BeginDate>
                  <EndDate>2006-06-22+10:00</EndDate>
                </Period>
                <CompanyId>5</CompanyId>
                <HeaderId>40099</HeaderId>
              </NominationHeader>
              <AMIQS>
    
```

```

<AMIQ>
  <IntervalId>1</IntervalId>
  <Value>10.0</Value>
</AMIQ>
<AMIQ>
  <IntervalId>2</IntervalId>
  <Value>20.0</Value>
</AMIQ>
<AMIQ>
  <IntervalId>3</IntervalId>
  <Value>10.0</Value>
</AMIQ>
<AMIQ>
  <IntervalId>4</IntervalId>
  <Value>15.5</Value>
</AMIQ>
<AMIQ>
  <IntervalId>5</IntervalId>
  <Value>10.0</Value>
</AMIQ>
</AMIQS>
</Nomination>
<Nomination>
  <NominationHeader>
    <Period>
      <BeginDate>2006-06-22+10:00</BeginDate>
      <EndDate>2006-07-31+10:00</EndDate>
    </Period>
    <CompanyId>5</CompanyId>
    <HeaderId>40098</HeaderId>
  </NominationHeader>
  <AMIQS>
    <AMIQ>
      <IntervalId>1</IntervalId>
      <Value>25.0</Value>
    </AMIQ>
    <AMIQ>
      <IntervalId>2</IntervalId>
      <Value>10.3</Value>
    </AMIQ>
    <AMIQ>
      <IntervalId>3</IntervalId>
      <Value>10.0</Value>
    </AMIQ>
    <AMIQ>
      <IntervalId>4</IntervalId>
      <Value>5.9</Value>
    </AMIQ>
    <AMIQ>
      <IntervalId>5</IntervalId>
      <Value>0.0</Value>
    </AMIQ>
  </AMIQS>
</Nomination>
</InjectionNominations>
</SearchResponseData>
</WholesaleSearchResponse>
</Transaction>
</Transactions>
</ase:aseXML>

```

## 5.6.5 SubmitInjectionHedgeNomination

### 5.6.5.1 Description

The `submitInjectionHedgeNomination()` operation submits injection hedge nomination information for processing by the WebExchanger application, using the

supplied date range, CPP MIRN (representing the aggregation of related individual SIP quantities), and other information.

IHN quantities supplied in the request must be of integer type, in GJ. AMIQ profile values are percentage. AMIQ profile values must be provided for every scheduling interval.

Participants are able to update their nominations of AMIQ during the gas day. AMIQ values submitted for prior and current scheduling intervals are locked in. Values for all 5 scheduling intervals are mandatory, however, regardless of the values provided for prior and current scheduling intervals, the system retains the previously locked in values. Only values for future scheduling intervals can be modified. IHN cannot be changed during the gas day.

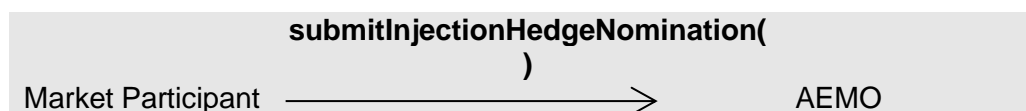

Request Parameter:

Complex type	GasIHNTType
--------------	-------------

Request Attributes:

xsi:type	GasSubmitRequestData
context	InjectionNomination
applyTo	GasSubmissionType



Response Parameter:

Complex type	GasIHNTType
--------------	-------------

Response Attributes:

xsi:type	GasSubmitResponseData
context	InjectionNomination

Note 1: In the request, if optional applyTo attribute is provided for current gas day, day ahead or two days ahead submission, then any values specified in the Period element will be ignored. The submission period will be automatically calculated by WebExchanger based on the current time. It is recommended that the applyTo attribute to be used for this type of the submission.

Note 2: In the request, if applyTo is set to “Standing”, then the Period element must be populated with the correct values. The Period’s EndDate (a.k.a.

termination date) must be at least one day ahead of BeginDate. The EndDate is not inclusive.

Note 3: The element Value of GasIHNAMEType must contain positive percentage value with up to 4 digits after decimal point.

Note 4: For a list of Close Proximity Points and Meter Description values please see the document “WebExchanger – Defined Data Lists” which can be found in the Documents folder in the Public Area of the MIBB (refer Related Documents table).

Note 5: If IHN quantities are not being supplied in the request, the IHNS element can be removed.

### 5.6.5.2 Input/Output Parameters

Input Element	GasSubmitRequestData
Input Schema	<pre> &lt;xsd:complexType name="GasSubmitRequestData"&gt;   &lt;xsd:complexContent&gt;     &lt;xsd:extension base="WholesaleSubmitRequestData"&gt;       &lt;xsd:choice&gt;         ...         &lt;xsd:element name="InjectionNomination" type="GasIHNTYPE"/&gt;         ...       &lt;/xsd:choice&gt;       &lt;xsd:attribute         name="version"         type="r31"         use="optional"         default="r31"/&gt;       &lt;xsd:attribute         name="contextType"         type="GasSubmissionTransactionType"         use="required"/&gt;       &lt;xsd:attribute         name="applyTo"         type="GasSubmissionType"         use="optional"/&gt;     &lt;/xsd:extension&gt;   &lt;/xsd:complexContent&gt; &lt;/xsd:complexType&gt; </pre>

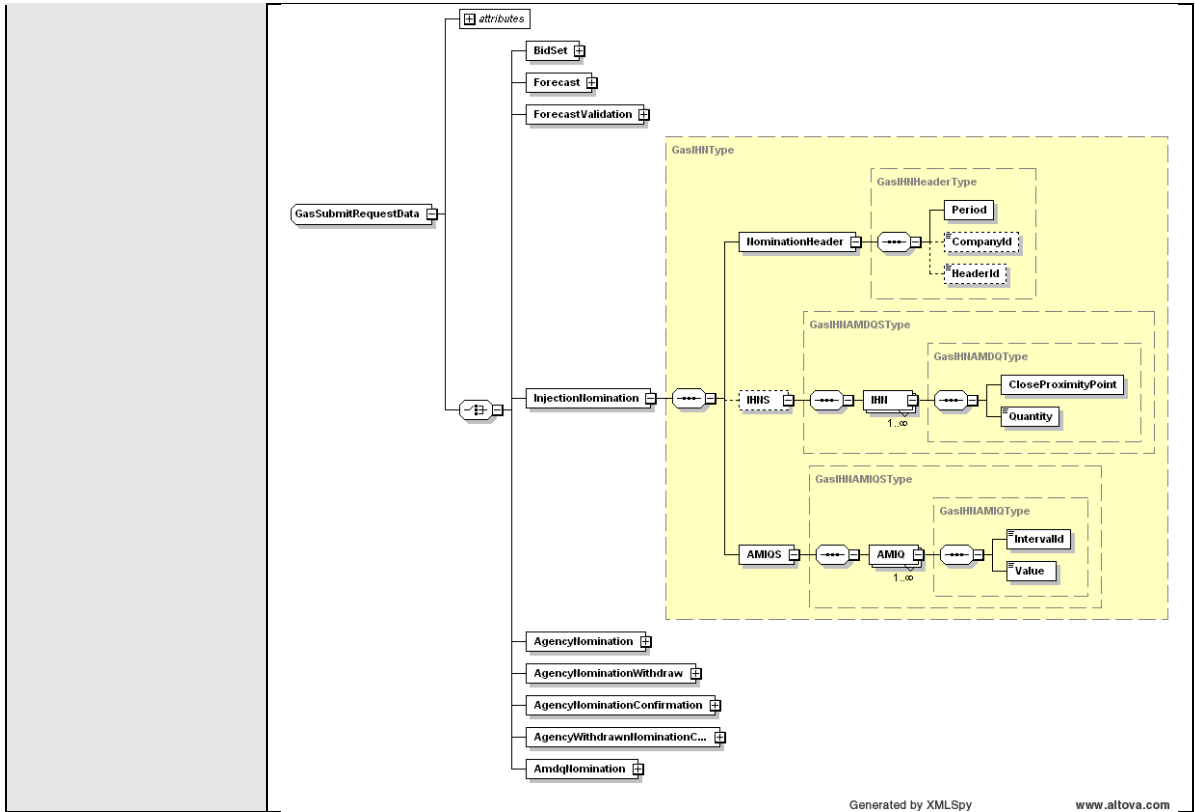

Output Element	GasSubmitResponseData
	<pre> &lt;xsd:complexType name="GasSubmitResponseData"&gt;   &lt;xsd:complexContent&gt;     &lt;xsd:extension base="WholesaleSubmitResponseData"&gt;       &lt;xsd:choice&gt;         ...         &lt;xsd:element name="InjectionNomination" type="GasIHNTType"/&gt;         ...       &lt;/xsd:choice&gt;       &lt;xsd:attribute         name="version"         type="r31"         use="optional"         default="r31"/&gt;       &lt;xsd:attribute         name="contextType"         type="GasSubmissionTransactionType"         use="required"/&gt;       &lt;xsd:attribute         name="applyTo"         type="GasSubmissionType"         use="optional"/&gt;     &lt;/xsd:extension&gt;   &lt;/xsd:complexContent&gt; &lt;/xsd:complexType&gt; </pre>

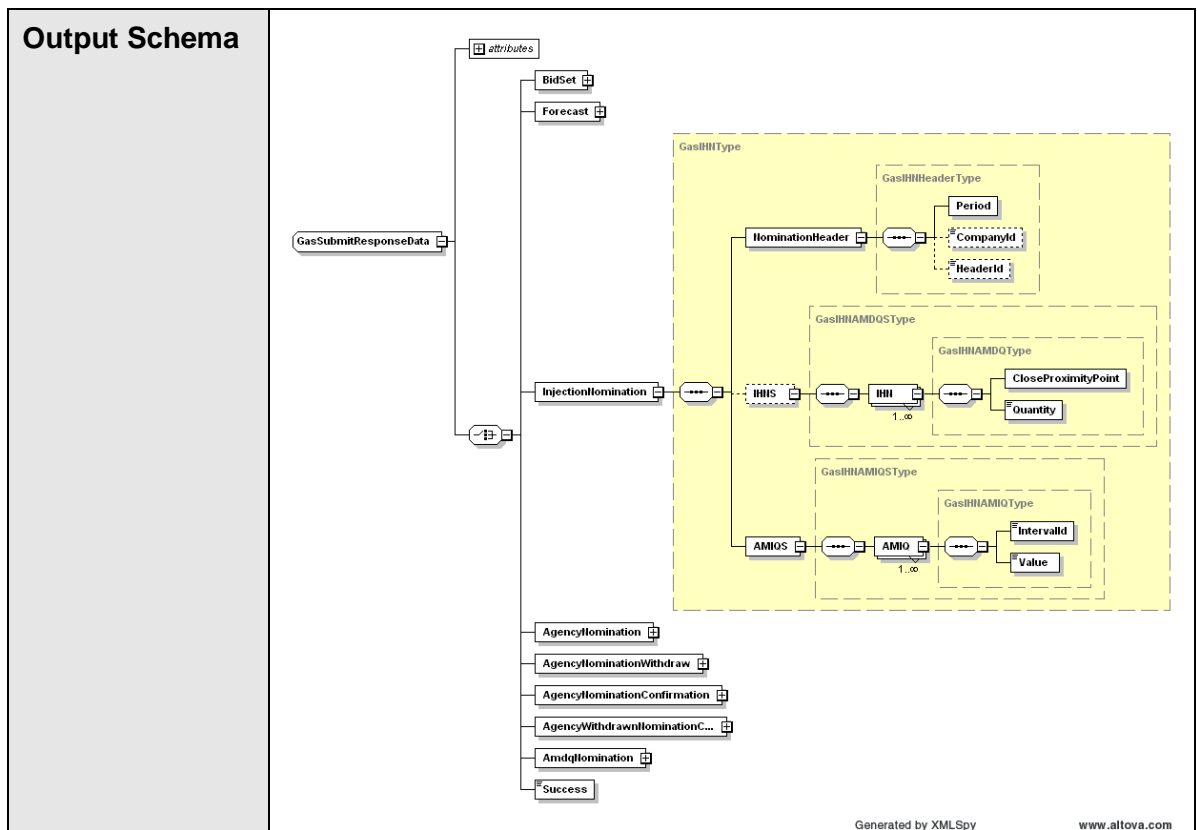

### 5.6.5.3 SOAP Faults

Fault Code	Fault Description
Global SOAP Faults	Refer to Global Fault Codes on page 61
3800	AMIQ profile validation failed
3801	Invalid number of AMIQ profile intervals
3802	The deadline for current gas day submissions has passed.
3803	<p>Invalid AMIQ percentage supplied. The total value from &lt;schedule time&gt; to &lt;schedule time&gt; must have a maximum limit of &lt;percentage&gt;. Invalid input amount = &lt;amount&gt;</p> <p><i>Note: For intra-day AMIQ profile revisions: &lt;schedule time&gt; field will be displayed as 6AM, 10AM, 2PM, 6PM or 10PM depending on the time of the AMIQ submission. &lt;percentage&gt; field will display the correct allowable percentage value according to the time of day the AMIQ profile is submitted. &lt;amount&gt; field will display the total AMIQ amount submitted</i></p> <p><i>If the AMIQ profile is submitted prior to the start of the gas day, &lt;schedule time&gt; will be displayed as 6AM and &lt;percentage&gt; will be displayed as 100.0.</i></p>
3804	AMIQ for previous scheduling intervals do not match submitted values.

Fault Code	Fault Description
3805	Invalid IHN values supplied - values must be numeric.
3806	Invalid IHN values supplied - values must not be empty.
3807	Invalid AMIQ values supplied - values must not be empty.
3809	Invalid AMIQ values supplied - values must not be negative.

### 5.6.5.4 Usage Examples

Request Sample 1 (with IHNS element)
<pre> &lt;ase:aseXML xmlns:ase="urn:aseXML:r31"&gt;   &lt;Header&gt;     &lt;From&gt;VENCorp WebExchanger Recipient&lt;/From&gt;     &lt;To&gt;VENCorp WebExchanger&lt;/To&gt;     &lt;MessageID&gt;45CFFD39-0BE8-FAE5-4399-5A1C10A32569&lt;/MessageID&gt;     &lt;MessageDate&gt;2006-06-19T16:26:50.375+10:00&lt;/MessageDate&gt;     &lt;TransactionGroup&gt;MKTW&lt;/TransactionGroup&gt;     &lt;Priority&gt;Medium&lt;/Priority&gt;     &lt;Market&gt;VICGAS&lt;/Market&gt;   &lt;/Header&gt;   &lt;Transactions&gt;     &lt;Transaction transactionID="45CFFD39-0BE8-FAE5-4399-5A1C10A32569"       transactionDate="2006-06-19T16:26:50.375+10:00"&gt;       &lt;WholesaleSubmitRequest version="r20"&gt;         &lt;SubmitRequestData           contextType="InjectionNomination"           applyTo="Standing"           xsi:type="urn:GasSubmitRequestData"           xmlns:urn="urn:aseXML:r31"           xmlns:xsi="http://www.w3.org/2001/XMLSchema-instance"&gt;           &lt;InjectionNomination&gt;             &lt;NominationHeader&gt;               &lt;Period&gt;                 &lt;BeginDate&gt;2007-05-01+10:00&lt;/BeginDate&gt;                 &lt;EndDate&gt;2007-07-04+10:00&lt;/EndDate&gt;               &lt;/Period&gt;             &lt;/NominationHeader&gt;             &lt;IHNS&gt;               &lt;IHN&gt;                 &lt;CloseProximityPoint&gt;30000001PC&lt;/CloseProximityPoint&gt;                 &lt;Quantity&gt;1570&lt;/Quantity&gt;               &lt;/IHN&gt;               &lt;IHN&gt;                 &lt;CloseProximityPoint&gt;30000154PC&lt;/CloseProximityPoint&gt;                 &lt;Quantity&gt;851&lt;/Quantity&gt;               &lt;/IHN&gt;             &lt;/IHNS&gt;             &lt;AMIQS&gt;               &lt;AMIQ&gt;                 &lt;IntervalId&gt;1&lt;/IntervalId&gt;                 &lt;Value&gt;25.67&lt;/Value&gt;               &lt;/AMIQ&gt;               &lt;AMIQ&gt;                 &lt;IntervalId&gt;2&lt;/IntervalId&gt;                 &lt;Value&gt;5.6&lt;/Value&gt;               &lt;/AMIQ&gt;               &lt;AMIQ&gt;                 &lt;IntervalId&gt;3&lt;/IntervalId&gt;                 &lt;Value&gt;0.0&lt;/Value&gt;               &lt;/AMIQ&gt;               &lt;AMIQ&gt;                 &lt;IntervalId&gt;4&lt;/IntervalId&gt;                 &lt;Value&gt;0.0&lt;/Value&gt;               &lt;/AMIQ&gt;             &lt;/AMIQS&gt;           &lt;/SubmitRequestData&gt;         &lt;/WholesaleSubmitRequest&gt;       &lt;/Transaction&gt;     &lt;/Transactions&gt;   &lt;/ase:aseXML&gt; </pre>



```

        </AMIQ>
        <AMIQ>
            <IntervalId>5</IntervalId>
            <Value>0.0</Value>
        </AMIQ>
    </AMIQS>
</InjectionNomination>
</SubmitRequestData>
</WholesaleSubmitRequest>
</Transaction>
</Transactions>
</ase:aseXML>
    
```

**Request Sample 2 (without IHNS element)**

```

<ase:aseXML xmlns:ase="urn:aseXML:r31">
  <Header>
    <From>VENCorp WebExchanger Recipient</From>
    <To>VENCorp WebExchanger</To>
    <MessageID>45CFFD39-0BE8-FAE5-4399-5A1C10A32569</MessageID>
    <MessageDate>2006-06-19T16:26:50.375+10:00</MessageDate>
    <TransactionGroup>MKTW</TransactionGroup>
    <Priority>Medium</Priority>
    <Market>VICGAS</Market>
  </Header>
  <Transactions>
    <Transaction transactionID="45CFFD39-0BE8-FAE5-4399-5A1C10A32569"
      transactionDate="2006-06-19T16:26:50.375+10:00">
      <WholesaleSubmitRequest version="r20">
        <SubmitRequestData
          contextType="InjectionNomination"
          applyTo="Standing"
          xsi:type="urn:GasSubmitRequestData"
          xmlns:urn="urn:aseXML:r31"
          xmlns:xsi="http://www.w3.org/2001/XMLSchema-instance">
          <InjectionNomination>
            <NominationHeader>
              <Period>
                <BeginDate>2007-05-01+10:00</BeginDate>
                <EndDate>2007-07-04+10:00</EndDate>
              </Period>
            </NominationHeader>
            <AMIQS>
              <AMIQ>
                <IntervalId>1</IntervalId>
                <Value>25.67</Value>
              </AMIQ>
              <AMIQ>
                <IntervalId>2</IntervalId>
                <Value>5.6</Value>
              </AMIQ>
              <AMIQ>
                <IntervalId>3</IntervalId>
                <Value>0.0</Value>
              </AMIQ>
              <AMIQ>
                <IntervalId>4</IntervalId>
                <Value>0.0</Value>
              </AMIQ>
              <AMIQ>
                <IntervalId>5</IntervalId>
                <Value>0.0</Value>
              </AMIQ>
            </AMIQS>
          </InjectionNomination>
        </SubmitRequestData>
      </WholesaleSubmitRequest>
    </Transaction>
  </Transactions>
</ase:aseXML>
    
```

### Response Sample 1 (with IHNS element)

```

<ase:aseXML xmlns:ase="urn:aseXML:r31">
<Header>
  <From>VENC Corp WebExchanger</From>
  <To>VENC Corp WebExchanger Recipient</To>
  <MessageID>3818824D-6835-4002-A67E-8CA742C4F5E7</MessageID>
  <MessageDate>2006-06-19T16:27:10.407+10:00</MessageDate>
  <TransactionGroup>MKTW</TransactionGroup>
  <Priority>Medium</Priority>
  <Market>VICGAS</Market>
</Header>
<Transactions>
  <Transaction transactionID="3818824D-6835-4002-A67E-8CA742C4F5E7"
    transactionDate="2006-06-19T16:27:10.407+10:00">
    <WholesaleSubmitResponse version="r20">
      <SubmitResponseData
        contextType="InjectionNomination"
        xsi:type="urn:GasSubmitResponseData"
        xmlns:urn="urn:aseXML:r31"
        xmlns:xsi="http://www.w3.org/2001/XMLSchema-instance">
        <InjectionNomination>
          <NominationHeader>
            <Period>
              <BeginDate>2007-05-01+10:00</BeginDate>
              <EndDate>2007-07-04+10:00</EndDate>
            </Period>
            <CompanyId>5</CompanyId>
            <HeaderId>40105</HeaderId>
          </NominationHeader>
          <IHNS>
            <IHN>
              <CloseProximityPoint>30000001PC</CloseProximityPoint>
              <Quantity>1570</Quantity>
            </IHN>
            <IHNS>
              <CloseProximityPoint>30000154PC</CloseProximityPoint>
              <Quantity>851</Quantity>
            </IHNS>
          </IHNS>
          <AMIQS>
            <AMIQ>
              <IntervalId>1</IntervalId>
              <Value>25.67</Value>
            </AMIQ>
            <AMIQ>
              <IntervalId>2</IntervalId>
              <Value>5.6</Value>
            </AMIQ>
            <AMIQ>
              <IntervalId>3</IntervalId>
              <Value>0.0</Value>
            </AMIQ>
            <AMIQ>
              <IntervalId>4</IntervalId>
              <Value>0.0</Value>
            </AMIQ>
            <AMIQ>
              <IntervalId>5</IntervalId>
              <Value>0.0</Value>
            </AMIQ>
          </AMIQS>
        </InjectionNomination>
      </SubmitResponseData>
    </WholesaleSubmitResponse>
  </Transaction>
</Transactions>
</ase:aseXML>

```

### Response Sample 2 (without IHNS element)

```

<ase:aseXML xmlns:ase="urn:aseXML:r31">
<Header>
  <From>VENCorp WebExchanger</From>
  <To>VENCorp WebExchanger Recipient</To>
  <MessageID>3818824D-6835-4002-A67E-8CA742C4F5E7</MessageID>
  <MessageDate>2006-06-19T16:27:10.407+10:00</MessageDate>
  <TransactionGroup>MKTW</TransactionGroup>
  <Priority>Medium</Priority>
  <Market>VICGAS</Market>
</Header>
<Transactions>
  <Transaction transactionID="3818824D-6835-4002-A67E-8CA742C4F5E7"
    transactionDate="2006-06-19T16:27:10.407+10:00">
    <WholesaleSubmitResponse version="r20">
      <SubmitResponseData
        contextType="InjectionNomination"
        xsi:type="urn:GasSubmitResponseData"
        xmlns:urn="urn:aseXML:r31"
        xmlns:xsi="http://www.w3.org/2001/XMLSchema-instance">
        <InjectionNomination>
          <NominationHeader>
            <Period>
              <BeginDate>2007-05-01+10:00</BeginDate>
              <EndDate>2007-07-04+10:00</EndDate>
            </Period>
            <CompanyId>5</CompanyId>
            <HeaderId>40105</HeaderId>
          </NominationHeader>
          <AMIQS>
            <AMIQ>
              <IntervalId>1</IntervalId>
              <Value>25.67</Value>
            </AMIQ>
            <AMIQ>
              <IntervalId>2</IntervalId>
              <Value>5.6</Value>
            </AMIQ>
            <AMIQ>
              <IntervalId>3</IntervalId>
              <Value>0.0</Value>
            </AMIQ>
            <AMIQ>
              <IntervalId>4</IntervalId>
              <Value>0.0</Value>
            </AMIQ>
            <AMIQ>
              <IntervalId>5</IntervalId>
              <Value>0.0</Value>
            </AMIQ>
          </AMIQS>
        </InjectionNomination>
      </SubmitResponseData>
    </WholesaleSubmitResponse>
  </Transaction>
</Transactions>
</ase:aseXML>

```

## 5.7 Web Service: Agency Injection Hedge Nomination Service

### 5.7.1 Introduction

The Agency Injection Hedge Nomination Service is responsible for all agency-related functionality. That includes all the functions available through the front-end browser interface, i.e. nomination of an agent, confirming nominations, withdrawal of nominations, and search for historical agency nominations.

Please note the usage of AgencyNominationHeaderId and AgencyNominationId:

- *AgencyNominationHeaderId* is an identifier for the entire group of nominations submitted at the same time. This corresponds to the Agency Nomination screen on the WebExchanger's browser interface where up to 10 agency nominations can be made. The *AgencyNominationHeaderId* is returned to the user following the successful submission of the group of nominations.
- *AgencyNominationId* is an identifier of the individual agency nomination as it is being tracked by the WebExchanger. This identifier appears next to the individual agency nomination following the successful submission. It is the identifier that will be returned/displayed when searching for nominations.

The individual agency injection hedge nomination lifecycle is depicted in the state transition diagram in the Figure 6, page 37.

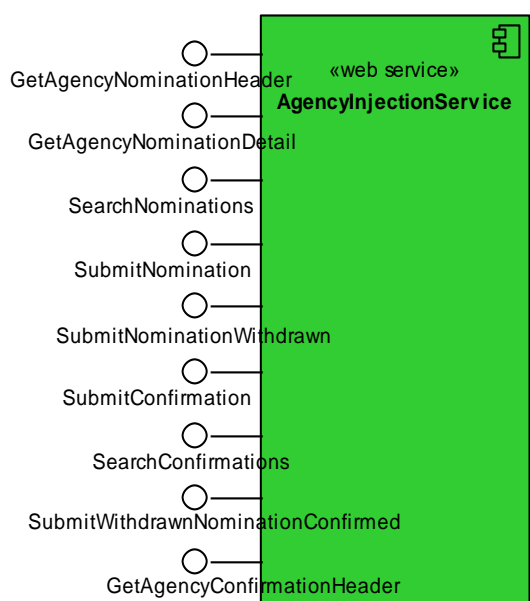

This service provides the following operations:

- GetAgencyNominationHeader
- GetAgencyNominationDetail
- SearchNominations
- SubmitNomination
- SubmitNominationWithdrawn
- SubmitConfirmation
- SearchConfirmations
- SubmitWithdrawnNominationConfirmed
- GetAgencyConfirmationHeader

## 5.7.2 GetAgencyNominationHeader

### 5.7.2.1 Description

The `getAgencyNominationHeader()` operation is responsible for the retrieval of the set of agency nominations identified by the provided header identifier – *AgencyNominationHeaderId*.

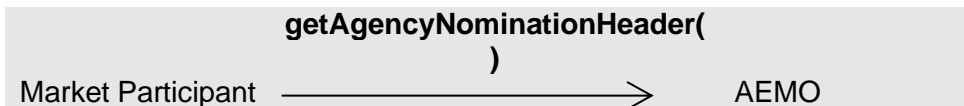

Request Parameter:

Simple type	AgencyNominationHeaderId
-------------	--------------------------

Request Attributes:

xsi:type	GasRetrieveRequestData
context	AgencyNominationHeader



Response Parameter:

Complex type	GasAgencyNomHeaderType
--------------	------------------------

Response Attributes:

xsi:type	GasRetrieveResponseData
context	AgencyNominationHeader

### 5.7.2.2 Input/Output Parameters

<b>Input Element</b>	GasRetrieveRequestData
<b>Input Schema</b>	<pre> &lt;xsd:complexType name="GasRetrieveRequestData"&gt;   &lt;xsd:complexContent&gt;     &lt;xsd:extension base="WholesaleRetrieveRequestData"&gt;       &lt;xsd:choice&gt;         ...         &lt;xsd:element           name="AgencyNominationHeaderId"           type="xsd:long"/&gt;         ...       &lt;/xsd:choice&gt;       &lt;xsd:attribute         name="version"         type="r30"         use="optional"         default="r30"/&gt;       </pre>

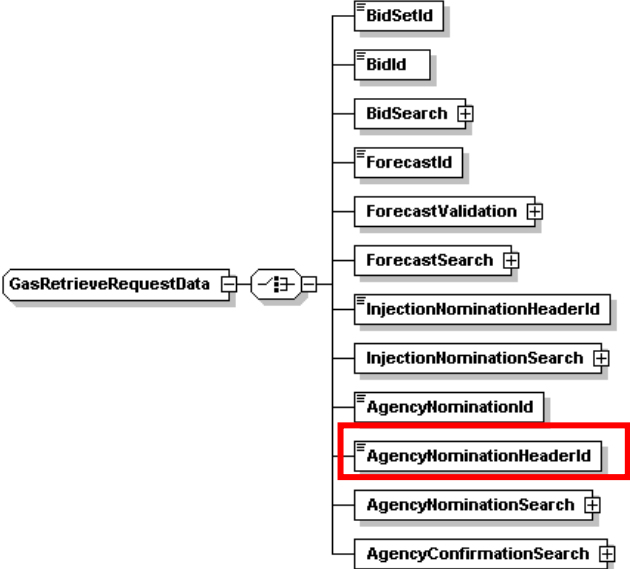
	<pre> &lt;xsd:attribute   name="contextType"   type="GasRetrieveTransactionType"   use="required"/&gt; &lt;/xsd:extension&gt; &lt;/xsd:complexContent&gt; &lt;/xsd:complexType&gt;         </pre> 
<p><b>Output Element</b></p>	<p>GasRetrieveResponseData</p>
	<pre> &lt;xsd:complexType name="GasRetrieveResponseData"&gt;   &lt;xsd:complexContent&gt;     &lt;xsd:extension base="WholesaleRetrieveResponseData"&gt;       &lt;xsd:sequence&gt;         &lt;xsd:choice&gt;           ...           &lt;xsd:element             name="AgencyNomination"             type="GasAgencyNomHeaderType"/&gt;           ...         &lt;/xsd:choice&gt;       &lt;/xsd:sequence&gt;     &lt;/xsd:extension&gt;   &lt;/xsd:complexContent&gt; &lt;/xsd:complexType&gt;         </pre>

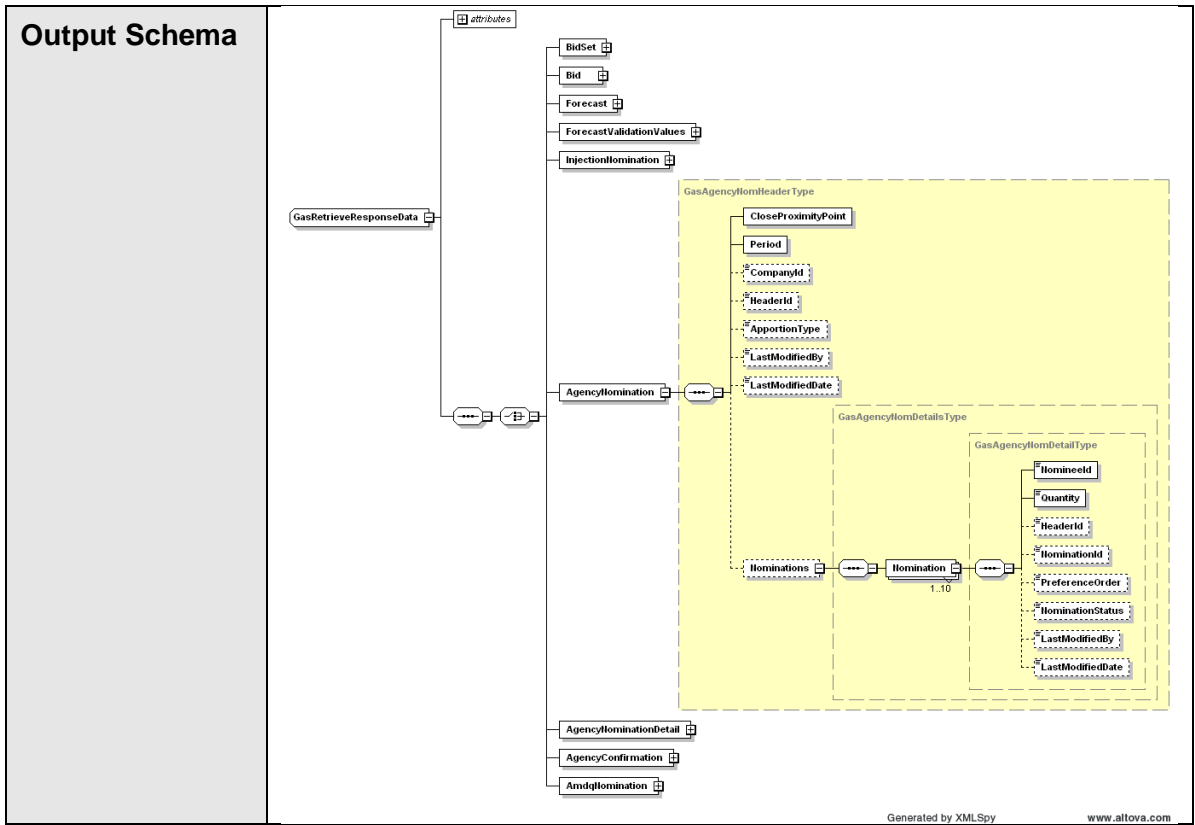

### 5.7.2.3 SOAP Faults

Fault Code	Fault Description
Global SOAP Faults	Refer to Global Fault Codes on page 61

### 5.7.2.4 Usage Examples

#### Request Sample

```

<ase:aseXML xmlns:ase="urn:aseXML:r31">
  <Header>
    <From>VENCorp WebExchanger Recipient</From>
    <To>VENCorp WebExchanger</To>
    <MessageID>4A102D37-1F49-3C52-19AA-91BB1B9CA5B7</MessageID>
    <MessageDate>2006-06-15T14:58:23.072+10:00</MessageDate>
    <TransactionGroup>MKTW</TransactionGroup>
    <Priority>Medium</Priority>
    <Market>VICGAS</Market>
  </Header>
  <Transactions>
    <Transaction transactionID="4A102D37-1F49-3C52-19AA-91BB1B9CA5B7"
      transactionDate="2006-06-15T14:58:23.072+10:00">
      <WholesaleRetrieveRequest version="r20">
        <RetrieveRequestData
          contextType="AgencyNominationHeader"
          xsi:type="urn:GasRetrieveRequestData"
          xmlns:urn="urn:aseXML:r31"
          xmlns:xsi="http://www.w3.org/2001/XMLSchema-instance">
          <AgencyNominationHeaderId>40343</AgencyNominationHeaderId>
        </RetrieveRequestData>
      </WholesaleRetrieveRequest>
    </Transaction>
  </Transactions>
</ase:aseXML>

```



### Response Sample

```

<ase:aseXML xmlns:ase="urn:aseXML:r31">
  <Header>
    <From>VENCorp WebExchanger</From>
    <To>VENCorp WebExchanger Recipient</To>
    <MessageID>5413EED8-E10B-EFB8-AFAD-EF0E9858C383</MessageID>
    <MessageDate>2006-06-15T14:58:25.760+10:00</MessageDate>
    <TransactionGroup>MKTW</TransactionGroup>
    <Priority>Medium</Priority>
    <Market>VICGAS</Market>
  </Header>
  <Transactions>
    <Transaction transactionID="5413EED8-E10B-EFB8-AFAD-EF0E9858C383"
      transactionDate="2006-06-15T14:58:25.760+10:00">
      <WholesaleRetrieveResponse version="r20">
        <RetrieveResponseData
          contextType="AgencyNominationHeader"
          xsi:type="urn:GasRetrieveResponseData"
          xmlns:urn="urn:aseXML:r31"
          xmlns:xsi="http://www.w3.org/2001/XMLSchema-instance">
          <AgencyNomination>
            <CloseProximityPoint>3000001PC</CloseProximityPoint>
            <Period>
              <BeginDate>2006-06-05+10:00</BeginDate>
              <EndDate>2006-06-05+10:00</EndDate>
            </Period>
            <HeaderId>40343</HeaderId>
            <CompanyId>10000</CompanyId>
            <ApportionType>PROR</ApportionType>
            <LastModifiedBy>wextestusr</LastModifiedBy>
            <LastModifiedDate>2006-06-05T09:06:38.786+10:00</LastModifiedDate>
            <Nominations>
              <Nomination>
                <NomineeId>10000</NomineeId>
                <Quantity>1000</Quantity>
                <HeaderId>40343</HeaderId>
                <NominationId>40369</NominationId>
                <NominationStatus>WCON</NominationStatus>
                <LastModifiedBy>wextest</LastModifiedBy>
                <LastModifiedDate>2006-06-05T09:06:38.793+10:00</LastModifiedDate>
              </Nomination>
            </Nominations>
          </AgencyNomination>
        </RetrieveResponseData>
      </WholesaleRetrieveResponse>
    </Transaction>
  </Transactions>
</ase:aseXML>

```

## 5.7.3 GetAgencyNominationDetail

### 5.7.3.1 Description

The `getAgencyNominationDetail()` operation is responsible for the retrieval of the individual nomination details as specified in the operation parameter.

Only nominations submitted by the logged in user, or another user within the same company/organization, will be viewable using this method.

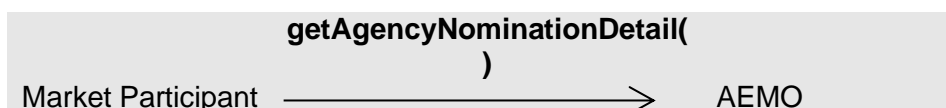

Request Parameter:

Simple type	AgencyNominationId
-------------	--------------------

Request Attributes:

xsi:type	GasRetrieveRequestData
context	AgencyNominationDetail



Response Parameter:

Complex type	GasAgencyNomDetailType
--------------	------------------------

Response Attributes:

xsi:type	GasRetrieveResponseData
context	AgencyNominationDetail

5.7.3.2 Input/Output Parameters

Input Element	GasRetrieveRequestData
Input Schema	<pre> &lt;xsd:complexType name="GasRetrieveRequestData"&gt;   &lt;xsd:complexContent&gt;     &lt;xsd:extension base="WholesaleRetrieveRequestData"&gt;       &lt;xsd:choice&gt;         ...         &lt;xsd:element name="AgencyNominationId" type="xsd:long"/&gt;         ...       &lt;/xsd:choice&gt;       &lt;xsd:attribute         name="version"         type="r30"         use="optional"         default="r30"/&gt;       &lt;xsd:attribute         name="contextType"         type="GasRetrieveTransactionType"         use="required"/&gt;     &lt;/xsd:extension&gt;   &lt;/xsd:complexContent&gt; &lt;/xsd:complexType&gt; </pre>

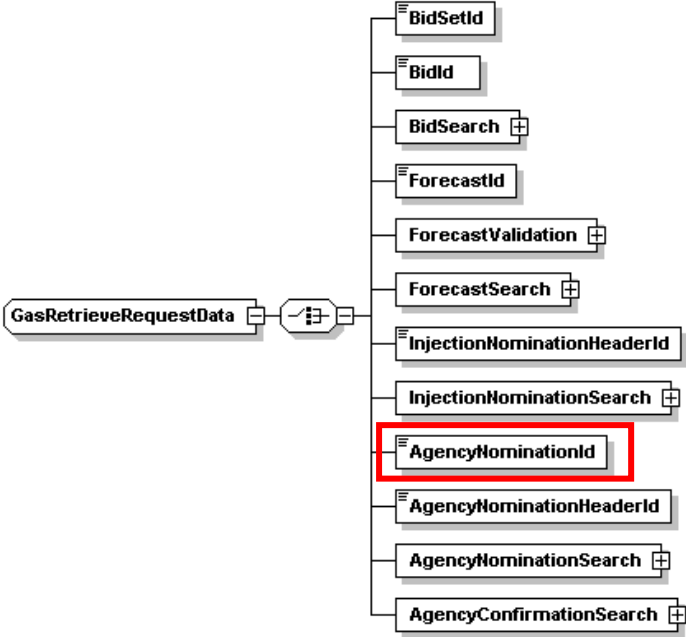
	
<p><b>Output Element</b></p>	<p>GasRetrieveResponseData</p> <pre> &lt;xsd:complexType name="GasRetrieveResponseData"&gt;   &lt;xsd:complexContent&gt;     &lt;xsd:extension base="WholesaleRetrieveResponseData"&gt;       &lt;xsd:sequence&gt;         &lt;xsd:choice&gt;           ...           &lt;xsd:element             name="AgencyNominationDetail"             type="GasAgencyNomDetailType"/&gt;           ...         &lt;/xsd:choice&gt;       &lt;/xsd:sequence&gt;       &lt;xsd:attribute         name="version"         type="r31"         use="optional"         default="r31"/&gt;       &lt;xsd:attribute         name="ContextType"         type="GasRetrieveTransactionType"         use="required"/&gt;     &lt;/xsd:extension&gt;   &lt;/xsd:complexContent&gt; &lt;/xsd:complexType&gt; </pre>

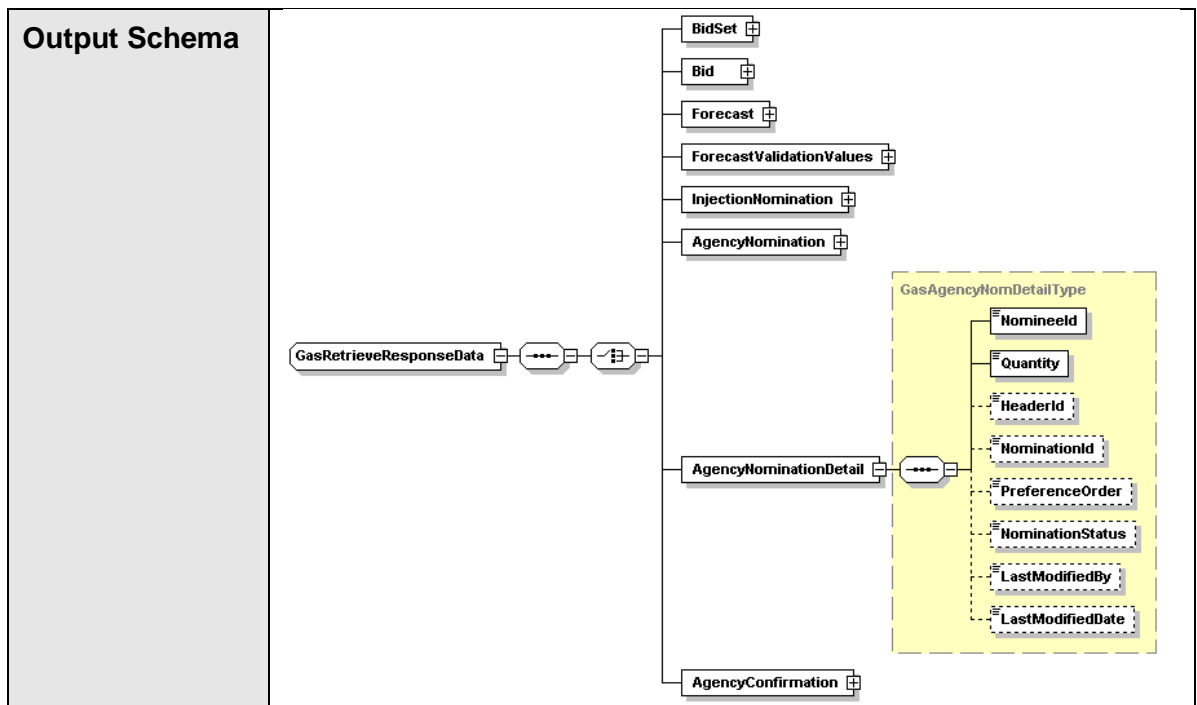

### 5.7.3.3 SOAP Faults

Fault Code	Fault Description
Global SOAP Faults	Refer to Global Fault Codes on page 61

### 5.7.3.4 Usage Scenarios

**Request Sample**

```

<ase:aseXML xmlns:ase="urn:aseXML:r31">
  <Header>
    <From>VENCorp WebExchanger Recipient</From>
    <To>VENCorp WebExchanger</To>
    <MessageID>FDAB3669-682C-7B01-4140-72B95948B76D</MessageID>
    <MessageDate>2006-06-23T09:56:49.769+10:00</MessageDate>
    <TransactionGroup>MKTW</TransactionGroup>
    <Priority>Medium</Priority>
    <Market>VICGAS</Market>
  </Header>
  <Transactions>
    <Transaction transactionID="FDAB3669-682C-7B01-4140-72B95948B76D"
      transactionDate="2006-06-23T09:56:49.769+10:00">
      <WholesaleRetrieveRequest version="r20">
        <RetrieveRequestData
          contextType="AgencyNominationDetail"
          xsi:type="urn:GasRetrieveRequestData"
          xmlns:urn="urn:aseXML:r31"
          xmlns:xsi="http://www.w3.org/2001/XMLSchema-instance">
          <AgencyNominationId>40408</AgencyNominationId>
        </RetrieveRequestData>
      </WholesaleRetrieveRequest>
    </Transaction>
  </Transactions>
</ase:aseXML>
    
```

### Response Sample

```

<ase:aseXML xmlns:ase="urn:aseXML:r31">
  <Header>
    <From>VENCORP WebExchanger</From>
    <To>VENCORP WebExchanger Recipient</To>
    <MessageID>0E4DD20F-1DF1-0B97-A5C5-DC92D34C5C89</MessageID>
    <MessageDate>2006-06-23T09:56:54.691+10:00</MessageDate>
    <TransactionGroup>MKTW</TransactionGroup>
    <Priority>Medium</Priority>
    <Market>VICGAS</Market>
  </Header>
  <Transactions>
    <Transaction transactionID="0E4DD20F-1DF1-0B97-A5C5-DC92D34C5C89"
      transactionDate="2006-06-23T09:56:54.691+10:00">
      <WholesaleRetrieveResponse version="r20">
        <RetrieveResponseData
          contextType="AgencyNominationDetail"
          xsi:type="urn:GasRetrieveResponseData"
          xmlns:urn="urn:aseXML:r31"
          xmlns:xsi="http://www.w3.org/2001/XMLSchema-instance">
          <AgencyNominationDetail>
            <NomineeId>42</NomineeId>
            <Quantity>20</Quantity>
            <HeaderId>40394</HeaderId>
            <NominationId>40408</NominationId>
            <NominationStatus>NOMD</NominationStatus>
            <LastModifiedBy>wextest</LastModifiedBy>
            <LastModifiedDate>2006-06-20T16:38:34.556+10:00</LastModifiedDate>
          </AgencyNominationDetail>
        </RetrieveResponseData>
      </WholesaleRetrieveResponse>
    </Transaction>
  </Transactions>
</ase:aseXML>

```

## 5.7.4 SearchNominations

### 5.7.4.1 Description

The `searchNominations()` operation is responsible for retrieval of the agency nominations that satisfy the search parameters.

The mandatory parameter `<NMI>` specifies the meter for which the search must be performed. The optional parameter `<Period>` defines the date range for which the agency nomination will be searched for. If not specified, then the current gas day will be assumed.

Only nominations submitted by the logged in user, or another user within the same company/organization, will be viewable using this method.

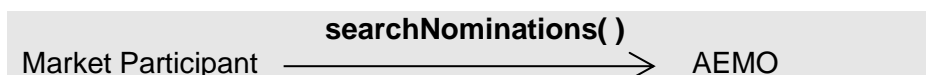

Request Parameter:

Complex type	GasAgencyNominationSearchType
--------------	-------------------------------

Request Attributes:

xsi:type	GasSearchRequestData
context	AgencyNomination



Response Parameter:

Complex type	GasAgencyNominationsType
--------------	--------------------------

Response Attributes:

xsi:type	GasSearchResponseData
context	AgencyNomination

5.7.4.2 Input/Output Parameters

Input Element	GasSearchRequestData
Input Schema	<pre> &lt;xsd:complexType name="GasSearchRequestData"&gt;   &lt;xsd:complexContent&gt;     &lt;xsd:extension base="WholesaleSearchRequestData"&gt;       &lt;xsd:choice&gt;         ...         &lt;xsd:element           name="AgencyNominationSearch"           type="GasAgencyNominationSearchType"/&gt;         ...       &lt;/xsd:choice&gt;       &lt;xsd:attribute         name="version"         type="r30"         use="optional"         default="r30"/&gt;       &lt;xsd:attribute         name="contextType"         type="GasSearchTransactionType"         use="required"/&gt;     &lt;/xsd:extension&gt;   &lt;/xsd:complexContent&gt; &lt;/xsd:complexType&gt; </pre>

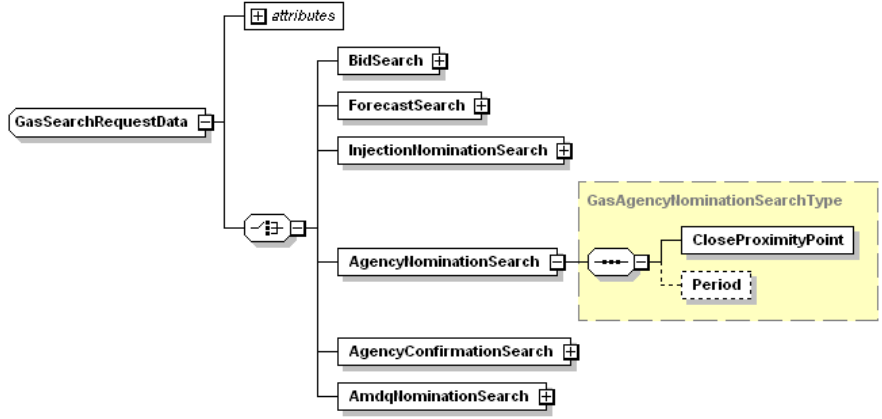
	 <p style="text-align: right;">Generated by XMLSpy <a href="http://www.altova.com">www.altova.com</a></p>
<b>Output Element</b>	<b>GasSearchResponseData</b>
	<pre> &lt;xsd:complexType name="GasSearchResponseData"&gt;   &lt;xsd:complexContent&gt;     &lt;xsd:extension base="WholesaleSearchResponseData"&gt;       &lt;xsd:choice&gt;         ...         &lt;xsd:element           name="AgencyNominations"           type="GasAgencyNominationsType" /&gt;         ...       &lt;/xsd:choice&gt;       &lt;xsd:attribute         name="version"         type="r31"         use="optional"         default="r31"/&gt;       &lt;xsd:attribute         name="contextType"         type="GasSearchTransactionType"         use="required"/&gt;     &lt;/xsd:extension&gt;   &lt;/xsd:complexContent&gt; &lt;/xsd:complexType&gt; </pre>

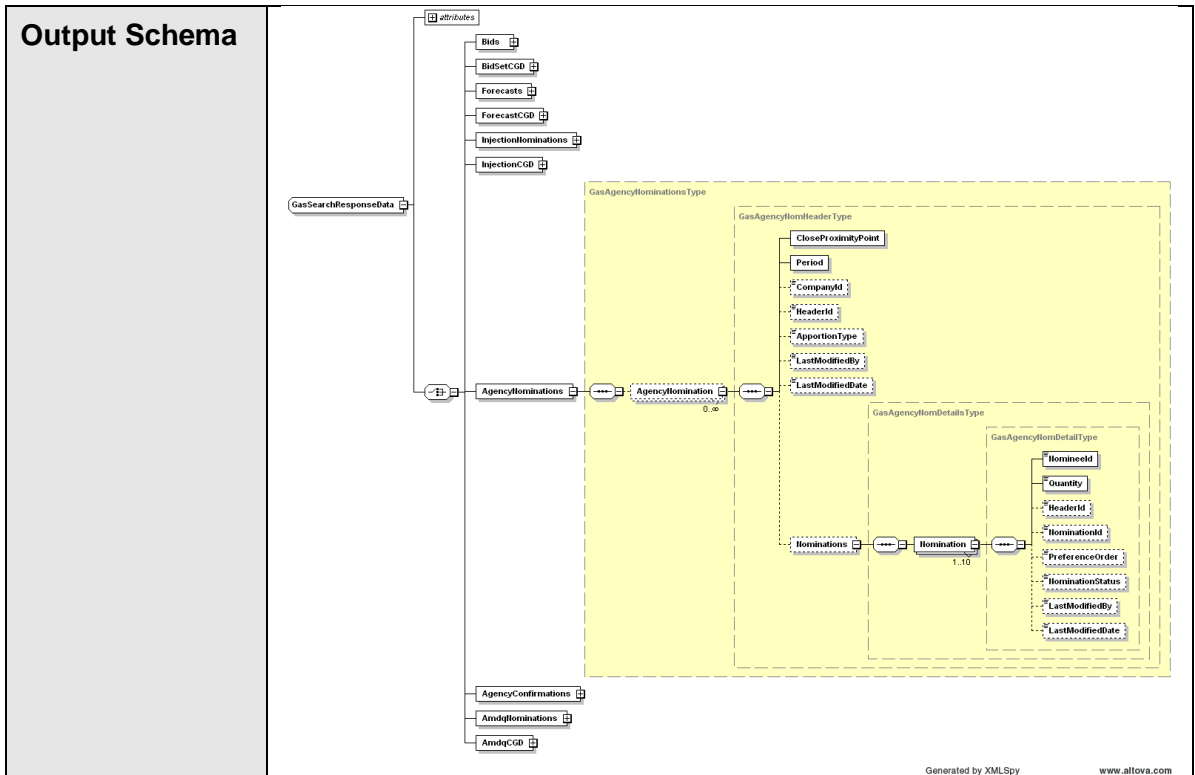

### 5.7.4.3 SOAP Faults

Fault Code	Fault Description
Global SOAP Faults	Refer to Global Fault Codes on page 61



### 5.7.4.4 Usage Examples

#### Request Sample

```
<ase:aseXML xmlns:ase="urn:aseXML:r31">
  <Header>
    <From>VENCorp WebExchanger Recipient</From>
    <To>VENCorp WebExchanger</To>
    <MessageID>034F2C78-F6B1-E108-263D-D63460121799</MessageID>
    <MessageDate>2006-06-15T14:59:37.603+10:00</MessageDate>
    <TransactionGroup>MKTW</TransactionGroup>
    <Priority>Medium</Priority>
    <Market>VICGAS</Market>
  </Header>
  <Transactions>
    <Transaction transactionID="034F2C78-F6B1-E108-263D-D63460121799"
      transactionDate="2006-06-15T14:59:37.603+10:00">
      <WholesaleSearchRequest version="r20">
        <SearchRequestData
          contextType="AgencyNomination"
          xsi:type="urn:GasSearchRequestData"
          xmlns:urn="urn:aseXML:r31"
          xmlns:xsi="http://www.w3.org/2001/XMLSchema-instance">
          <AgencyNominationSearch>
            <CloseProximityPoint>30000001PC</CloseProximityPoint>
            <Period>
              <BeginDate>2006-06-05+10:00</BeginDate>
              <EndDate>2012-06-06+10:00</EndDate>
            </Period>
          </AgencyNominationSearch>
        </SearchRequestData>
      </WholesaleSearchRequest>
    </Transaction>
  </Transactions>
</ase:aseXML>
```

#### Response Sample

```
<ase:aseXML xmlns:ase="urn:aseXML:r31">
  <Header>
    <From>VENCorp WebExchanger</From>
    <To>VENCorp WebExchanger Recipient</To>
    <MessageID>E0AF78F6-DF98-D09E-F931-7A594A290290</MessageID>
    <MessageDate>2006-06-15T14:59:46.525+10:00</MessageDate>
    <TransactionGroup>MKTW</TransactionGroup>
    <Priority>Medium</Priority>
    <Market>VICGAS</Market>
  </Header>
  <Transactions>
    <Transaction transactionID="E0AF78F6-DF98-D09E-F931-7A594A290290"
      transactionDate="2006-06-15T14:59:46.525+10:00">
      <WholesaleSearchResponse version="r20">
        <SearchResponseData
          contextType="AgencyNomination"
          xsi:type="urn:GasSearchResponseData"
          xmlns:urn="urn:aseXML:r31"
          xmlns:xsi="http://www.w3.org/2001/XMLSchema-instance">
          <AgencyNominations>
            <AgencyNomination>
              <CloseProximityPoint>30000001PC</CloseProximityPoint>
              <Period>
                <BeginDate>2006-06-05+10:00</BeginDate>
                <EndDate>2010-06-05+10:00</EndDate>
              </Period>
              <HeaderId>40331</HeaderId>
              <CompanyId>10000</CompanyId>
              <ApportionType>PREF</ApportionType>
              <LastModifiedBy>wextest</LastModifiedBy>
              <LastModifiedDate>2006-06-05T09:06:31.540+10:00</LastModifiedDate>
            </AgencyNomination>
          </AgencyNominations>
        </SearchResponseData>
      </WholesaleSearchResponse>
    </Transaction>
  </Transactions>
</ase:aseXML>
```

```

<Nominations>
  <Nomination>
    <NomineeId>10010</NomineeId>
    <Quantity>1234</Quantity>
    <HeaderId>40331</HeaderId>
    <NominationId>40357</NominationId>
    <PreferenceOrder>1</PreferenceOrder>
    <NominationStatus>NOMD</NominationStatus>
    <LastModifiedBy>wextest</LastModifiedBy>
    <LastModifiedDate>2006-06-05T09:06:31.576+10:00</LastModifiedDate>
  </Nomination>
  <Nomination>
    <NomineeId>10021</NomineeId>
    <Quantity>3000</Quantity>
    <HeaderId>40331</HeaderId>
    <NominationId>40459</NominationId>
    <PreferenceOrder>2</PreferenceOrder>
    <NominationStatus>NOMD</NominationStatus>
    <LastModifiedBy>wextest</LastModifiedBy>
    <LastModifiedDate>2006-06-05T09:06:31.576+10:00</LastModifiedDate>
  </Nomination>
</Nominations>
</AgencyNomination>

<AgencyNomination>
  <CloseProximityPoint>30000002PC</CloseProximityPoint>
  <Period>
    <BeginDate>2006-06-05+10:00</BeginDate>
    <EndDate>2006-06-05+10:00</EndDate>
  </Period>
  <HeaderId>40332</HeaderId>
  <CompanyId>10001</CompanyId>
  <ApportionType>PROR</ApportionType>
  <LastModifiedBy>wextest1</LastModifiedBy>
  <LastModifiedDate>2006-06-05T09:06:36.323+10:00</LastModifiedDate>
  <Nominations>
    <Nomination>
      <NomineeId>10011</NomineeId>
      <Quantity>1000</Quantity>
      <HeaderId>40332</HeaderId>
      <NominationId>40358</NominationId>
      <NominationStatus>NOMD</NominationStatus>
      <LastModifiedBy>wextest1</LastModifiedBy>
      <LastModifiedDate>2006-06-05T09:06:36.330+10:00</LastModifiedDate>
    </Nomination>
  </Nominations>
</AgencyNomination>

<AgencyNomination>
  <CloseProximityPoint>30000003PC</CloseProximityPoint>
  <Period>
    <BeginDate>2006-06-05+10:00</BeginDate>
    <EndDate>2006-06-05+10:00</EndDate>
  </Period>
  <HeaderId>40333</HeaderId>
  <CompanyId>10000</CompanyId>
  <ApportionType>PROR</ApportionType>
  <LastModifiedBy>wextest</LastModifiedBy>
  <LastModifiedDate>2006-06-05T09:06:36.546+10:00</LastModifiedDate>
  <Nominations>
    <Nomination>
      <NomineeId>10013</NomineeId>
      <Quantity>1000</Quantity>
      <HeaderId>40333</HeaderId>
      <NominationId>40359</NominationId>
      <NominationStatus>NOMD</NominationStatus>
      <LastModifiedBy>wextest</LastModifiedBy>
      <LastModifiedDate>2006-06-05T09:06:36.553+10:00</LastModifiedDate>
    </Nomination>
  </Nominations>
</AgencyNomination>

```

```

<AgencyNomination>
  <CloseProximityPoint>30000004PC</CloseProximityPoint>
  <Period>
    <BeginDate>2006-06-05+10:00</BeginDate>
    <EndDate>2006-06-05+10:00</EndDate>
  </Period>
  <HeaderId>40334</HeaderId>
  <CompanyId>10001</CompanyId>
  <ApportionType>PROR</ApportionType>
  <LastModifiedBy>wextest1</LastModifiedBy>
  <LastModifiedDate>2006-06-05T09:06:36.716+10:00</LastModifiedDate>
  <Nominations>
    <Nomination>
      <NomineeId>10014</NomineeId>
      <Quantity>1000</Quantity>
      <HeaderId>40334</HeaderId>
      <NominationId>40360</NominationId>
      <NominationStatus>NCON</NominationStatus>
      <LastModifiedBy>wextest</LastModifiedBy>
      <LastModifiedDate>2006-06-05T09:06:36.726+10:00</LastModifiedDate>
    </Nomination>
  </Nominations>
</AgencyNomination>

<AgencyNomination>
  <CloseProximityPoint>30000005PC</CloseProximityPoint>
  <Period>
    <BeginDate>2006-06-05+10:00</BeginDate>
    <EndDate>2006-06-05+10:00</EndDate>
  </Period>
  <HeaderId>40335</HeaderId>
  <CompanyId>10002</CompanyId>
  <ApportionType>PROR</ApportionType>
  <LastModifiedBy>wextest2</LastModifiedBy>
  <LastModifiedDate>2006-06-05T09:06:36.950+10:00</LastModifiedDate>
  <Nominations>
    <Nomination>
      <NomineeId>10015</NomineeId>
      <Quantity>1000</Quantity>
      <HeaderId>40335</HeaderId>
      <NominationId>40361</NominationId>
      <NominationStatus>NCON</NominationStatus>
      <LastModifiedBy>wextest</LastModifiedBy>
      <LastModifiedDate>2006-06-05T09:06:36.960+10:00</LastModifiedDate>
    </Nomination>
  </Nominations>
</AgencyNomination>

<AgencyNomination>
  <CloseProximityPoint>30000006PC</CloseProximityPoint>
  <Period>
    <BeginDate>2006-06-05+10:00</BeginDate>
    <EndDate>2006-06-05+10:00</EndDate>
  </Period>
  <HeaderId>40336</HeaderId>
  <CompanyId>10000</CompanyId>
  <ApportionType>PROR</ApportionType>
  <LastModifiedBy>wextest</LastModifiedBy>
  <LastModifiedDate>2006-06-05T09:06:37.103+10:00</LastModifiedDate>
  <Nominations>
    <Nomination>
      <NomineeId>10016</NomineeId>
      <Quantity>1000</Quantity>
      <HeaderId>40336</HeaderId>
      <NominationId>40362</NominationId>
      <NominationStatus>NCON</NominationStatus>
      <LastModifiedBy>wextest</LastModifiedBy>
      <LastModifiedDate>2006-06-05T09:06:37.110+10:00</LastModifiedDate>
    </Nomination>
  </Nominations>
</AgencyNomination>
    
```

```

        </AgencyNominations>
    </SearchResponseData>
</WholesaleSearchResponse>
</Transaction>
</Transactions>
</ase:aseXML>

```

## 5.7.5 SubmitNomination

### 5.7.5.1 Description

The `submitNomination()` operation will allow the user to submit the agency injection hedge nomination to the WebExchanger application.

The user will be able to submit nominations for CPP meters (representing the aggregation of related [individual SIP quantities](#)) registered to the company/organisation the logged in user belongs to.

Upon successful submission, the WebExchanger application will generate notification emails (in accordance with the specification in Section 2.6.3, page 42 of this document) to the nominated party and the company/organisation who created the nomination.

The relationship between `ApportionType` and `PreferenceOrder` elements for respective nomination(s) is specified in the following table:

**Table 11. Apportionment types**

Apportionment	Acceptable values
PROR	0
PREF	1..10

Note:

For a list of Close Proximity Points and Meter Description values please see the document "WebExchanger – Defined Data Lists" (refer Related Documents table)

Nomination status element `NominationStatus` must be populated with one of the values shown in the table below. The response to this request will reflect the actual status of the nomination as stored by WebExchanger.

**Table 12. Nomination status**

Nomination status	Description
NOMD	Agency is nominated
NCON	Agency nomination is confirmed
NWDN	Agency nomination is withdrawn

WCON	Agency nomination withdrawal is confirmed
------	---

Note 1: The element `ApportionType` is business-mandatory for the agency nomination submission. If the `ApportionType` is set to `PREF`, then `PreferenceOrder` element must be provided as well. `PreferenceOrder` element should not be used for the `ApportionType` `PROR`.

Note 2: Preference order has to be provided in ascending order.

Note 3: In the request, if optional `applyTo` attribute is provided for current gas day, day ahead or two days ahead submission, then any values specified in the `Period` element will be ignored. The submission period will be automatically calculated by WebExchanger based on the current time. It is recommended that the `applyTo` attribute to be used for this type of the submission.

Note 4: In the request, if `applyTo` is set to "Standing", then the `Period` element must be populated with the correct values. The `Period`'s `EndDate` (a.k.a. termination date) must be at least one day ahead of `BeginDate`. The `EndDate` is not inclusive.

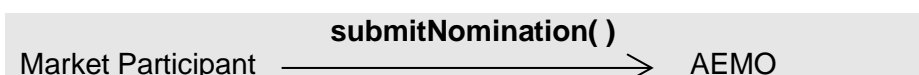

Request Parameter:

Complex type	GasAgencyNomHeaderType
--------------	------------------------

Request Attributes:

<code>xsi:type</code>	GasSubmitRequestData
<code>context</code>	AgencyNomination
<code>applyTo</code>	GasSubmissionType



Response Parameter:

Complex type	GasAgencyNomHeaderType
--------------	------------------------

Response Attributes:

<code>xsi:type</code>	GasSubmitResponseData
<code>context</code>	AgencyNomination

### 5.7.5.2 Input/Output Parameters

<b>Input Element</b>	GasSubmitRequestData
<b>Input Schema</b>	<pre> &lt;xsd:complexType name="GasSubmitRequestData"&gt;   &lt;xsd:complexContent&gt;     &lt;xsd:extension base="WholesaleSubmitRequestData"&gt;       &lt;xsd:choice&gt;         ...         &lt;xsd:element name="AgencyNomination"           type="GasAgencyNomHeaderType"/&gt;         ...       &lt;/xsd:choice&gt;       &lt;xsd:attribute         name="version"         type="r31"         use="optional"         default="r31"/&gt;       &lt;xsd:attribute         name="contextType"         type="GasSubmissionTransactionType"         use="required"/&gt;       &lt;xsd:attribute         name="applyTo"         type="GasSubmissionType"         use="optional"/&gt;     &lt;/xsd:extension&gt;   &lt;/xsd:complexContent&gt; &lt;/xsd:complexType&gt;                 </pre>
<b>Output Element</b>	GasSubmitResponseData
	<pre> &lt;xsd:complexType name="GasSubmitResponseData"&gt;   &lt;xsd:complexContent&gt;     &lt;xsd:extension base="WholesaleSubmitResponseData"&gt;       &lt;xsd:choice&gt;                 </pre>

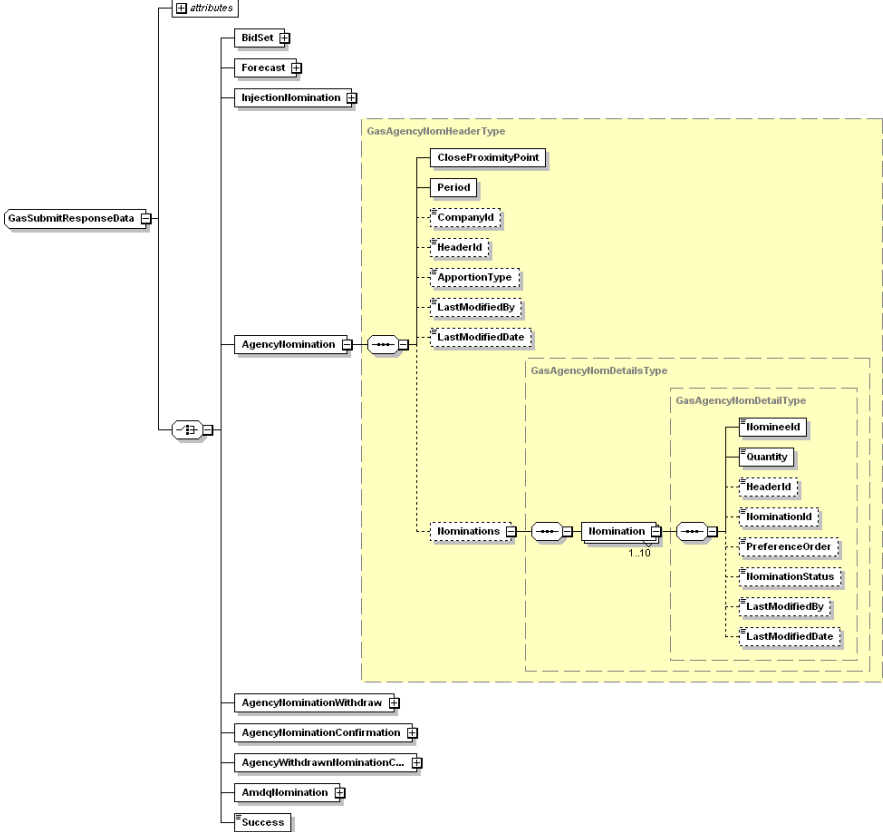
	<pre> ... &lt;xsd:element name="AgencyNomination"              type="GasAgencyNomHeaderType"/&gt; ... &lt;/xsd:choice&gt; &lt;xsd:attribute   name="version"   type="r31"   use="optional"   default="r31"/&gt; &lt;xsd:attribute   name="contextType"   type="GasSubmissionTransactionType"   use="required"/&gt; &lt;xsd:attribute   name="applyTo"   type="GasSubmissionType"   use="optional"/&gt; &lt;/xsd:extension&gt; &lt;/xsd:complexContent&gt; &lt;/xsd:complexType&gt;         </pre>
<p><b>Output Schema</b></p>	 <p>The diagram illustrates the XML Schema structure. The root element is <code>GasSubmitResponseData</code>, which contains several elements: <code>BitSet</code>, <code>Forecast</code>, <code>InjectionNomination</code>, <code>AgencyNomination</code>, and <code>Success</code>. The <code>AgencyNomination</code> element is further detailed with nested types: <code>GasAgencyNomHeaderType</code> (containing <code>CloseProximityPoint</code>, <code>Period</code>, <code>CompanyId</code>, <code>HeaderId</code>, <code>ApportionType</code>, <code>LastModifiedBy</code>, and <code>LastModifiedDate</code>), <code>GasAgencyNomDetailsType</code> (containing <code>Nominations</code>), and <code>GasAgencyNomDetailType</code> (containing <code>NomineId</code>, <code>Quantity</code>, <code>HeaderId</code>, <code>NominationId</code>, <code>PreferenceOrder</code>, <code>NominationStatus</code>, <code>LastModifiedBy</code>, and <code>LastModifiedDate</code>). The <code>Nominations</code> element is shown as a list of <code>Nomination</code> elements, with a cardinality of 1..10.</p>

**5.7.5.3 SOAP Faults**

Fault Code	Fault Description
Global SOAP Faults	Refer to Global Fault Codes on page 61
3700	Invalid agency nomination status type supplied.
3701	Apportionment method must be supplied.

Fault Code	Fault Description
3702	Preference order must be supplied.
3703	A market participant must be provided if an agency nomination value has been specified.
3704	There is an overlapping nomination or confirmed nomination already present in the system for this date range. Please withdraw the nomination before proceeding.
3705	The cutoff time for agency nominations for this date range has expired.
3706	Preference order must be in ascending order, start with 1 and does not contain any gaps.
3707	There are duplicate market participants provided for this nomination. A market participant can only be nominated once for Apportionment Type Prorata.
3708	The operation you have attempted is using a nominee that is invalid.
3709	Nominations submitted for withdrawal have previously been withdrawn.
3710	Nominations submitted for confirmation have previously been confirmed.
3711	Nominations submitted for confirmation withdrawal have previously been confirmed for withdrawal.
3712	The nomination you have attempted to perform this operation on is in the wrong state. Please check the current state of this nomination.
3713	A quantity must be provided for all nominees provided. The quantity cannot be left blank or have a value of zero.



### 5.7.5.4 Usage Examples

#### Request Sample

```

<ase:aseXML xmlns:ase="urn:aseXML:r31">
  <Header>
    <From>VENCorp WebExchanger Recipient</From>
    <To>VENCorp WebExchanger</To>
    <MessageID>8B3F9AF9-D2F4-E330-7DB1-349C7A0B9462</MessageID>
    <MessageDate>2006-06-15T15:55:20.019+10:00</MessageDate>
    <TransactionGroup>MKTW</TransactionGroup>
    <Priority>Medium</Priority>
    <Market>VICGAS</Market>
  </Header>
  <Transactions>
    <Transaction transactionID="8B3F9AF9-D2F4-E330-7DB1-349C7A0B9462"
      transactionDate="2006-06-15T15:55:20.019+10:00">
      <WholesaleSubmitRequest version="r20">
        <SubmitRequestData
          version="r31"
          contextType="AgencyNomination"
          applyTo="Standing"
          xsi:type="urn:GasSubmitRequestData"
          xmlns:urn="urn:aseXML:r31"
          xmlns:xsi="http://www.w3.org/2001/XMLSchema-instance">
          <AgencyNomination>
            <CloseProximityPoint>3000001PC</CloseProximityPoint>
            <Period>
              <BeginDate>2101-01-10+10:00</BeginDate>
              <EndDate>2101-01-20+10:00</EndDate>
            </Period>
            <CompanyId>5</CompanyId>
            <ApportionType>PROR</ApportionType>
            <Nominations>
              <Nomination>
                <NomineeId>42</NomineeId>
                <Quantity>1234</Quantity>
                <NominationStatus>NOMD</NominationStatus>
              </Nomination>
            </Nominations>
          </AgencyNomination>
        </SubmitRequestData>
      </WholesaleSubmitRequest>
    </Transaction>
  </Transactions>
</ase:aseXML>

```

## Response Sample

```

<ase:aseXML xmlns:ase="urn:aseXML:r31">
  <Header>
    <From>VENC Corp WebExchanger</From>
    <To>VENC Corp WebExchanger Recipient</To>
    <MessageID>852A365D-EDA5-EE14-C881-41F99AEB9AE</MessageID>
    <MessageDate>2006-06-15T15:59:20.267+10:00</MessageDate>
    <TransactionGroup>MKTW</TransactionGroup>
    <Priority>Medium</Priority>
    <Market>VICGAS</Market>
  </Header>
  <Transactions>
    <Transaction transactionID="852A365D-EDA5-EE14-C881-41F99AEB9AE"
      transactionDate="2006-06-15T15:59:20.267+10:00">
      <WholesaleSubmitResponse version="r20">
        <SubmitResponseData
          contextType="AgencyNomination"
          xsi:type="urn:GasSubmitResponseData"
          xmlns:urn="urn:aseXML:r31"
          xmlns:xsi="http://www.w3.org/2001/XMLSchema-instance">
          <AgencyNomination>
            <CloseProximityPoint>3000001PC</CloseProximityPoint>
            <Period>
              <BeginDate>2101-01-10+10:00</BeginDate>
              <EndDate>2101-01-20+10:00</EndDate>
            </Period>
            <HeaderId>40370</HeaderId>
            <CompanyId>5</CompanyId>
            <ApportionType>PROR</ApportionType>
            <LastModifiedBy>wextest</LastModifiedBy>
            <LastModifiedDate>2006-06-15T15:59:19.873+10:00</LastModifiedDate>
            <Nominations>
              <Nomination>
                <NomineeId>42</NomineeId>
                <Quantity>1234</Quantity>
                <HeaderId>40370</HeaderId>
                <NominationId>40386</NominationId>
                <NominationStatus>NOMD</NominationStatus>
                <LastModifiedBy>wextest</LastModifiedBy>
                <LastModifiedDate>2006-06-15T15:59:19.880+10:00</LastModifiedDate>
              </Nomination>
            </Nominations>
          </AgencyNomination>
        </SubmitResponseData>
      </WholesaleSubmitResponse>
    </Transaction>
  </Transactions>
</ase:aseXML>

```

## 5.7.6 SubmitNominationWithdrawn

### 5.7.6.1 Description

The `submitNominationWithdrawn()` operation allows the user to withdraw the previously submitted agency nomination. It does not provide for the withdrawal of the entire nomination group (as identified by the header id), but rather the individual nomination (as identified by the nomination id)

An individual nomination can be withdrawn either before the confirmation for that nomination is submitted, or after the confirmation. In both cases notifications will be generated by WebExchanger to the counterparties, see state transition diagram in Figure 6, page 37.

Upon successful submission, the status of the nomination will be set to "NWDN".

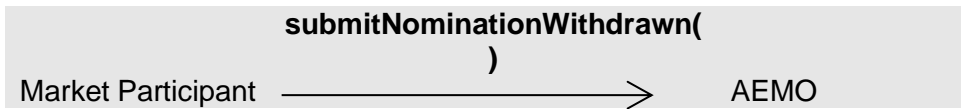

Request Parameter:

Complex type	GasAgencyConfirmationType
--------------	---------------------------

Request Attributes:

xsi:type	GasSubmitRequestData
context	AgencyNominationWithdraw
applyTo	GasSubmissionType



Response Parameter:

Complex type	GasAgencyNomHeaderType
--------------	------------------------

Response Attributes:

xsi:type	GasSubmitResponseData
context	AgencyNominationWithdraw

### 5.7.6.2 Input/Output Parameters

<b>Input Element</b>	GasSubmitRequestData
<b>Input Schema</b>	<pre> &lt;xsd:complexType name="GasSubmitRequestData"&gt;   &lt;xsd:complexContent&gt;     &lt;xsd:extension base="WholesaleSubmitRequestData"&gt;       &lt;xsd:choice&gt;         ...         &lt;xsd:element name="AgencyNominationWithdraw"           type="GasAgencyConfirmationType"/&gt;         ...       &lt;/xsd:choice&gt;       &lt;xsd:attribute         name="version"         type="r31"         use="optional"         default="r31"/&gt;       &lt;xsd:attribute         name="contextType"         type="GasSubmissionTransactionType"         use="required"/&gt;       &lt;xsd:attribute         name="applyTo"         type="GasSubmissionType"         use="optional"/&gt;     </pre>

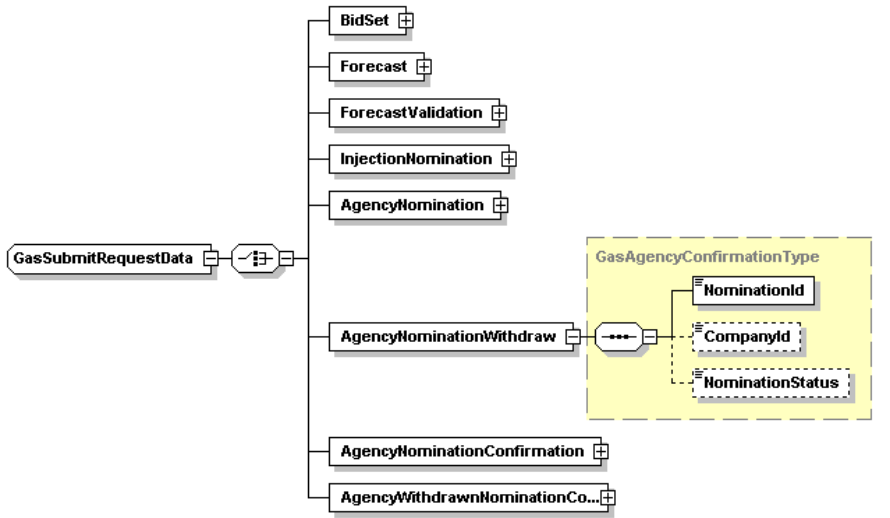
	<pre> &lt;/xsd:extension&gt; &lt;/xsd:complexContent&gt; &lt;/xsd:complexType&gt;                 </pre> 
<p><b>Output Element</b></p>	<p>GasSubmitResponseData</p>
	<pre> &lt;xsd:complexType name="GasSubmitResponseData"&gt;   &lt;xsd:complexContent&gt;     &lt;xsd:extension base="WholesaleSubmitResponseData"&gt;       &lt;xsd:choice&gt;         ...         &lt;xsd:element name="AgencyNominationWithdraw"           type="GasAgencyNomHeaderType"/&gt;         ...       &lt;/xsd:choice&gt;       &lt;xsd:attribute         name="version"         type="r31"         use="optional"         default="r31"/&gt;       &lt;xsd:attribute         name="contextType"         type="GasSubmissionTransactionType"         use="required"/&gt;       &lt;xsd:attribute         name="applyTo"         type="GasSubmissionType"         use="optional"/&gt;     &lt;/xsd:extension&gt;   &lt;/xsd:complexContent&gt; &lt;/xsd:complexType&gt;                 </pre>



### 5.7.6.4 Usage Examples

#### Request Sample

```

<ase:aseXML xmlns:ase="urn:aseXML:r31">
  <Header>
    <From>VENCorp WebExchanger Recipient</From>
    <To>VENCorp WebExchanger</To>
    <MessageID>7AAE9204-B3BE-676A-B284-5055C373E893</MessageID>
    <MessageDate>2006-06-22T11:38:00.440+10:00</MessageDate>
    <TransactionGroup>MKTW</TransactionGroup>
    <Priority>Medium</Priority>
    <Market>VICGAS</Market>
  </Header>
  <Transactions>
    <Transaction transactionID="7AAE9204-B3BE-676A-B284-5055C373E893"
      transactionDate="2006-06-22T11:38:00.440+10:00">
      <WholesaleSubmitRequest version="r20">
        <SubmitRequestData
          version="r31"
          contextType="AgencyNominationWithdraw"
          xsi:type="urn:GasSubmitRequestData"
          xmlns:urn="urn:aseXML:r31"
          xmlns:xsi="http://www.w3.org/2001/XMLSchema-instance">
          <AgencyNominationWithdraw>
            <NominationId>40415</NominationId>
            <CompanyId>5</CompanyId>
            <NominationStatus>NWDN</NominationStatus>
          </AgencyNominationWithdraw>
        </SubmitRequestData>
      </WholesaleSubmitRequest>
    </Transaction>
  </Transactions>
</ase:aseXML>

```

## Response Sample

```
<ase:aseXML xmlns:ase="urn:aseXML:r31">
  <Header>
    <From>VENCorp WebExchanger</From>
    <To>VENCorp WebExchanger Recipient</To>
    <MessageID>6A78178B-108E-FFCA-69C3-E4AB0FAA8580</MessageID>
    <MessageDate>2006-06-22T11:38:08.424+10:00</MessageDate>
    <TransactionGroup>MKTW</TransactionGroup>
    <Priority>Medium</Priority>
    <Market>VICGAS</Market>
  </Header>
  <Transactions>
    <Transaction transactionID="6A78178B-108E-FFCA-69C3-E4AB0FAA8580"
      transactionDate="2006-06-22T11:38:08.424+10:00">
      <WholesaleSubmitResponse version="r20">
        <SubmitResponseData
          contextType="AgencyNominationWithdraw"
          xsi:type="urn:GasSubmitResponseData"
          xmlns:urn="urn:aseXML:r31"
          xmlns:xsi="http://www.w3.org/2001/XMLSchema-instance">
          <AgencyNominationWithdraw>
            <CloseProximityPoint>3000001PC</CloseProximityPoint>
            <Period>
              <BeginDate>2101-06-15+10:00</BeginDate>
              <EndDate>2101-06-20+10:00</EndDate>
            </Period>
            <HeaderId>40411</HeaderId>
            <CompanyId>5</CompanyId>
            <ApportionType>PREF</ApportionType>
            <LastModifiedBy>wextest</LastModifiedBy>
            <LastModifiedDate>2006-06-22T11:34:01.573+10:00</LastModifiedDate>
            <Nominations>
              <Nomination>
                <NomineeId>42</NomineeId>
                <Quantity>1234</Quantity>
                <HeaderId>40411</HeaderId>
                <NominationId>40415</NominationId>
                <PreferenceOrder>1</PreferenceOrder>
                <NominationStatus>NWDN</NominationStatus>
                <LastModifiedBy>wextest2</LastModifiedBy>
                <LastModifiedDate>2006-06-22T11:38:07.653+10:00</LastModifiedDate>
              </Nomination>
            </Nominations>
          </AgencyNominationWithdraw>
        </SubmitResponseData>
      </WholesaleSubmitResponse>
    </Transaction>
  </Transactions>
</ase:aseXML>
```

## 5.7.7 SubmitConfirmation

### 5.7.7.1 Description

The `submitConfirmation()` operation is responsible for submission of a confirmation for the individual agency hedge nomination. This confirmation, upon successful submission, will change the status of the specified agency nomination to "NCON".

The successful operation will trigger a notifications sent to both parties.

Only nominations submitted to the logged-in agent, or another user within the same agent's company/organization, will be updateable using this method.



Request Parameter:

Complex type	GasAgencyConfirmationType
--------------	---------------------------

Request Attributes:

xsi:type	GasSubmitRequestData
context	AgencyNominationConfirmation
applyTo	GasSubmissionType



Response Parameter:

Complex type	GasAgencyConfirmationHeaderType
--------------	---------------------------------

Response Attributes:

xsi:type	GasSubmitResponseData
context	AgencyNominationConfirmation

### 5.7.7.2 Input/Output Parameters

Input Element	GasSubmitRequestData
Input Schema	<pre> &lt;xsd:complexType name="GasSubmitRequestData"&gt;   &lt;xsd:complexContent&gt;     &lt;xsd:extension base="WholesaleSubmitRequestData"&gt;       &lt;xsd:choice&gt;         ...         &lt;xsd:element name="AgencyNominationConfirmation"           type="GasAgencyConfirmationType"/&gt;         ...       &lt;/xsd:choice&gt;       &lt;xsd:attribute         name="version"         type="r31"         use="optional"         default="r31"/&gt;       &lt;xsd:attribute         name="contextType"         type="GasSubmissionTransactionType"         use="required"/&gt;       &lt;xsd:attribute         name="applyTo"         type="GasSubmissionType"         use="optional"/&gt;     &lt;/xsd:extension&gt;   &lt;/xsd:complexContent&gt; &lt;/xsd:complexType&gt;           </pre>

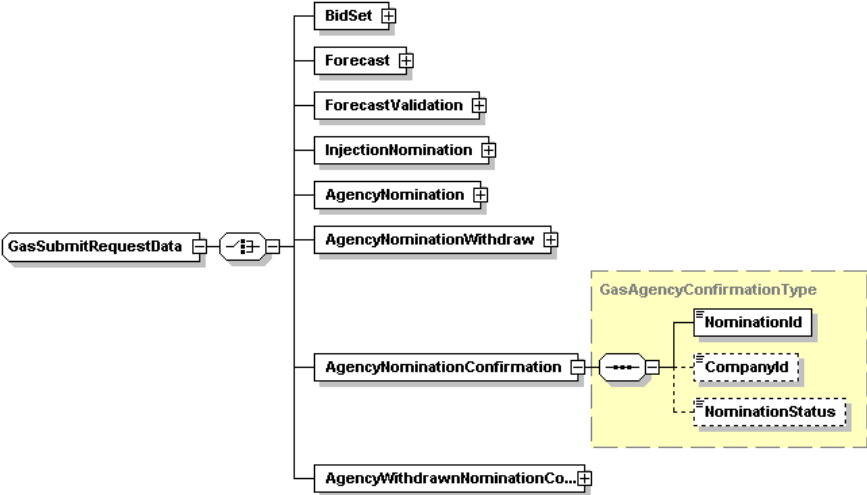

	
<p><b>Output Element</b></p>	<p>GasSubmitResponseData</p>
	<pre> &lt;xsd:complexType name="GasSubmitResponseData"&gt;   &lt;xsd:complexContent&gt;     &lt;xsd:extension base="WholesaleSubmitResponseData"&gt;       &lt;xsd:choice&gt;         ...         &lt;xsd:element name="AgencyNominationConfirmation"           type="GasAgencyConfirmationHeaderType"/&gt;         ...       &lt;/xsd:choice&gt;       &lt;xsd:attribute         name="version"         type="r31"         use="optional"         default="r31"/&gt;       &lt;xsd:attribute         name="contextType"         type="GasSubmissionTransactionType"         use="required"/&gt;       &lt;xsd:attribute         name="applyTo"         type="GasSubmissionType"         use="optional"/&gt;     &lt;/xsd:extension&gt;   &lt;/xsd:complexContent&gt; &lt;/xsd:complexType&gt;         </pre>

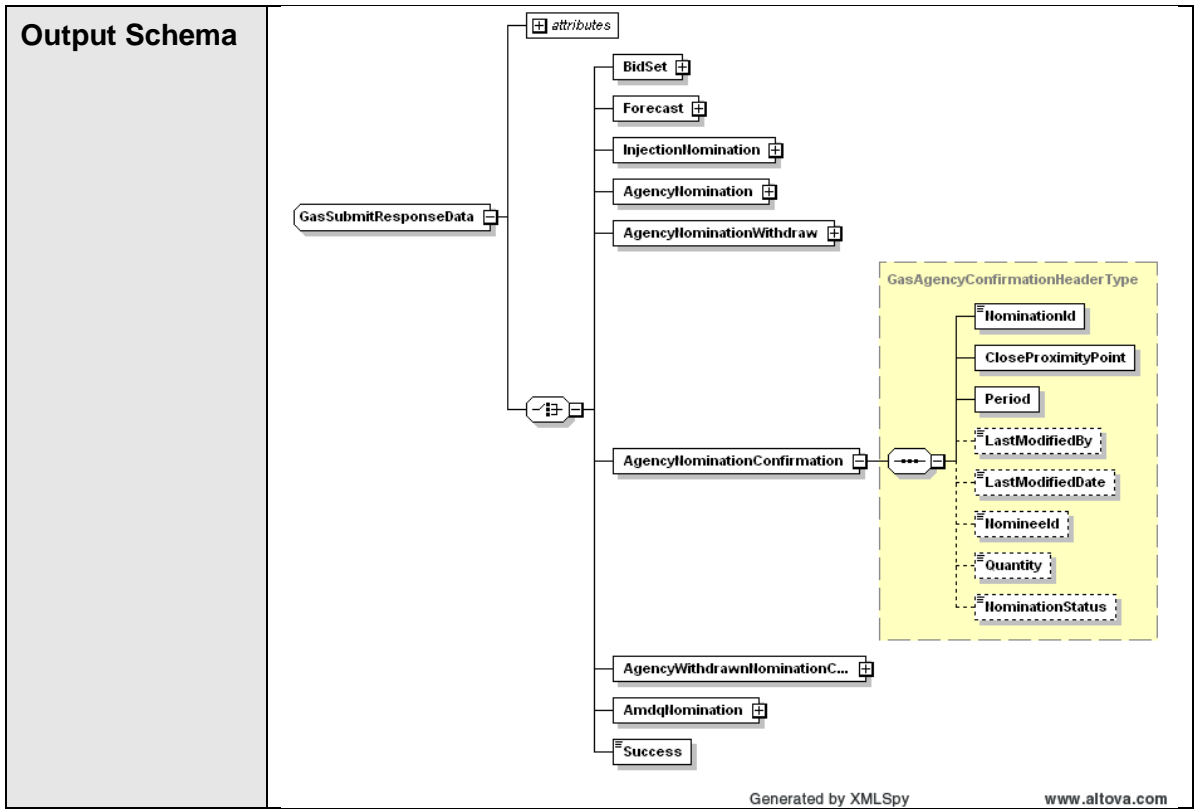

5.7.7.3 SOAP Faults

Fault Code	Fault Description
Global SOAP Faults	Refer to Global Fault Codes on page 61

### 5.7.7.4 Usage Examples

#### Request Sample

```

<ase:aseXML xmlns:ase="urn:aseXML:r31">
  <Header>
    <From>VENCorp WebExchanger Recipient</From>
    <To>VENCorp WebExchanger</To>
    <MessageID>CCD69FB3-2EA8-BA15-76F1-457670E0D620</MessageID>
    <MessageDate>2006-06-22T11:49:24.612+10:00</MessageDate>
    <TransactionGroup>MKTW</TransactionGroup>
    <Priority>Medium</Priority>
    <Market>VICGAS</Market>
  </Header>
  <Transactions>
    <Transaction transactionID="CCD69FB3-2EA8-BA15-76F1-457670E0D620"
      transactionDate="2006-06-22T11:49:24.612+10:00">
      <WholesaleSubmitRequest version="r20">
        <SubmitRequestData
          contextType="AgencyNominationConfirmation"
          xsi:type="urn:GasSubmitRequestData"
          xmlns:urn="urn:aseXML:r31"
          xmlns:xsi="http://www.w3.org/2001/XMLSchema-instance">
          <AgencyNominationConfirmation>
            <NominationId>40416</NominationId>
            <CompanyId>42</CompanyId>
            <NominationStatus>NCON</NominationStatus>
          </AgencyNominationConfirmation>
        </SubmitRequestData>
      </WholesaleSubmitRequest>
    </Transaction>
  </Transactions>
</ase:aseXML>

```

```

Response Sample
<ase:aseXML xmlns:ase="urn:aseXML:r31">
  <Header>
    <From>VENCorp WebExchanger</From>
    <To>VENCorp WebExchanger Recipient</To>
    <MessageID>E3F8C5E3-6CB7-E9CC-4FDF-8E15302D907C</MessageID>
    <MessageDate>2006-06-22T11:49:30.565+10:00</MessageDate>
    <TransactionGroup>MKTW</TransactionGroup>
    <Priority>Medium</Priority>
    <Market>VICGAS</Market>
  </Header>
  <Transactions>
    <Transaction transactionID="E3F8C5E3-6CB7-E9CC-4FDF-8E15302D907C"
      transactionDate="2006-06-22T11:49:30.565+10:00">
      <WholesaleSubmitResponse version="r20">
        <SubmitResponseData
          contextType="AgencyNominationConfirmation"
          xsi:type="urn:GasSubmitResponseData"
          xmlns:urn="urn:aseXML:r31"
          xmlns:xsi="http://www.w3.org/2001/XMLSchema-instance">
          <AgencyNominationConfirmation>
            <NominationId>40416</NominationId>
            <CloseProximityPoint>30000001PC</CloseProximityPoint>
            <Period>
              <BeginDate>2006-08-22+10:00</BeginDate>
              <EndDate>2006-08-23+10:00</EndDate>
            </Period>
            <LastModifiedBy>wextest</LastModifiedBy>
            <LastModifiedDate>2006-06-22T11:49:29.690+10:00</LastModifiedDate>
            <NomineeId>5</NomineeId>
            <Quantity>77000</Quantity>
            <NominationStatus>NCON</NominationStatus>
          </AgencyNominationConfirmation>
        </SubmitResponseData>
      </WholesaleSubmitResponse>
    </Transaction>
  </Transactions></ase:aseXML>
    
```

## 5.7.8 SearchConfirmations

### 5.7.8.1 Description

The searchConfirmation() operation is responsible for searching the submitted agency nomination confirmations. The only confirmations submitted by the logged in user, or another user from the same company/organisation will be viewable from this operation.



Request Parameter:

Complex type	GasAgencyConfirmationSearchType
--------------	---------------------------------

Request Attributes:

xsi:type	GasSearchRequestData
context	AgencyConfirmation



Response Parameter:

Complex type	GasAgencyConfirmationsType
--------------	----------------------------

Response Attributes:

xsi:type	GasSearchResponseData
context	AgencyConfirmation

### 5.7.8.2 Input/Output Parameters

<b>Input Element</b>	GasSearchRequestData
<b>Input Schema</b>	<pre>&lt;xsd:complexType name="GasSearchRequestData"&gt;   &lt;xsd:complexContent&gt;     &lt;xsd:extension base="WholesaleSearchRequestData"&gt;       &lt;xsd:choice&gt;         ...         &lt;xsd:element name="AgencyConfirmationSearch"           type="GasAgencyConfirmationSearchType"/&gt;         ...       &lt;/xsd:choice&gt;       &lt;xsd:attribute         name="version"         type="r30"         use="optional"         default="r30"/&gt;       &lt;xsd:attribute         name="contextType"         type="GasSearchTransactionType"         use="required"/&gt;     &lt;/xsd:extension&gt;   &lt;/xsd:complexContent&gt; &lt;/xsd:complexType&gt;</pre> <p style="text-align: right; font-size: small;">Generated by XMLSpy <a href="http://www.altova.com">www.altova.com</a></p>
<b>Output Element</b>	GasSearchResponseData
	<pre>&lt;xsd:complexType name="GasSearchResponseData"&gt;   &lt;xsd:complexContent&gt;     &lt;xsd:extension base="WholesaleSearchResponseData"&gt;</pre>

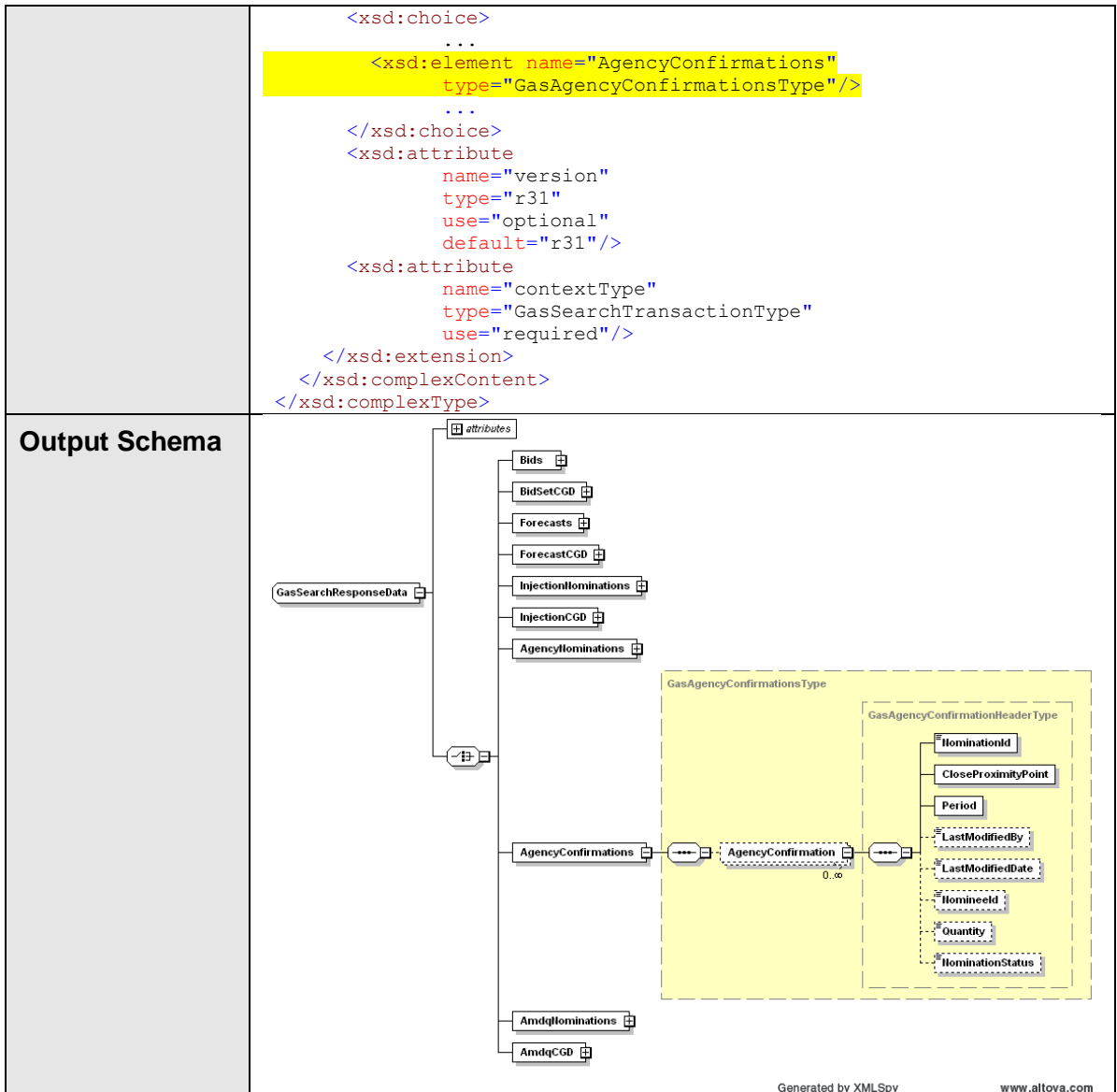

### 5.7.8.3 SOAP Faults

Fault Code	Fault Description
Global SOAP Faults	Refer to Global Fault Codes on page 61

### 5.7.8.4 Usage Examples

#### Request Sample

```

<ase:aseXML xmlns:ase="urn:aseXML:r31">
  <Header>
    <From>VENCorp WebExchanger Recipient</From>
    <To>VENCorp WebExchanger</To>
    <MessageID>D4DAB81C-BAC7-DC01-B24C-36BC92763EFC</MessageID>
    <MessageDate>2006-06-22T11:44:58.456+10:00</MessageDate>
    <TransactionGroup>MKTW</TransactionGroup>
    <Priority>Medium</Priority>
    <Market>VICGAS</Market>
  </Header>
  <Transactions>
    <Transaction transactionID="D4DAB81C-BAC7-DC01-B24C-36BC92763EFC"
      transactionDate="2006-06-22T11:44:58.456+10:00">
      <WholesaleSearchRequest version="r20">
        <SearchRequestData
          contextType="AgencyConfirmation"
          xsi:type="urn:GasSearchRequestData"
          xmlns:urn="urn:aseXML:r31"
          xmlns:xsi="http://www.w3.org/2001/XMLSchema-instance">
          <AgencyConfirmationSearch>
            <CloseProximityPoint>30000001PC</CloseProximityPoint>
            <Period>
              <BeginDate>2101-06-01+10:00</BeginDate>
              <EndDate>2101-06-25+10:00</EndDate>
            </Period>
            <InjectorId>5</InjectorId>
          </AgencyConfirmationSearch>
        </SearchRequestData>
      </WholesaleSearchRequest>
    </Transaction>
  </Transactions>
</ase:aseXML>

```

### Response Sample

```
<ase:aseXML xmlns:ase="urn:aseXML:r31">
  <Header>
    <From>VENCorp WebExchanger</From>
    <To>VENCorp WebExchanger Recipient</To>
    <MessageID>2A129029-2088-DDA0-469E-F2DEBBE81C6C</MessageID>
    <MessageDate>2006-06-22T11:45:03.190+10:00</MessageDate>
    <TransactionGroup>MKTW</TransactionGroup>
    <Priority>Medium</Priority>
    <Market>VICGAS</Market>
  </Header>
  <Transactions>
    <Transaction transactionID="2A129029-2088-DDA0-469E-F2DEBBE81C6C"
      transactionDate="2006-06-22T11:45:03.190+10:00">
      <WholesaleSearchResponse version="r20">
        <SearchResponseData
          contextType="AgencyConfirmation"
          xsi:type="urn:GasSearchResponseData"
          xmlns:urn="urn:aseXML:r31"
          xmlns:xsi="http://www.w3.org/2001/XMLSchema-instance">
          <AgencyConfirmations>
            <AgencyConfirmation>
              <NominationId>40415</NominationId>
              <CloseProximityPoint>3000001PC</CloseProximityPoint>
              <Period>
                <BeginDate>2101-06-15+10:00</BeginDate>
                <EndDate>2101-06-20+10:00</EndDate>
              </Period>
              <LastModifiedBy>wextest3</LastModifiedBy>
              <LastModifiedDate>2006-06-22T11:38:07.653+10:00</LastModifiedDate>
              <NomineeId>5</NomineeId>
              <Quantity>1234</Quantity>
              <NominationStatus>NWDN</NominationStatus>
            </AgencyConfirmation>
          </AgencyConfirmations>
        </SearchResponseData>
      </WholesaleSearchResponse>
    </Transaction>
  </Transactions>
</ase:aseXML>
```

## 5.7.9 SubmitWithdrawnNominationConfirmed

### 5.7.9.1 Description

The `submitWithdrawnNominationConfirmed()` operation is responsible for submission of the confirmation for the the retracted nomination, i.e. the nomination that had been withdrawn.

Only nominations made to the logged-in user, or another user from the same company/organisation will be updateable via this operation.

The successful submission via this operation will change the status of the specified nomination to "WCON".



Request Parameter:



Complex type	GasAgencyConfirmationType
--------------	---------------------------

Request Attributes:

xsi:type	GasSubmitRequestData
context	AgencyWithdrawnNominationConfirmed
applyTo	GasSubmissionType



Response Parameter:

Complex type	GasAgencyConfirmationHeaderType
--------------	---------------------------------

Response Attributes:

xsi:type	GasSubmitResponseData
context	AgencyWithdrawnNominationConfirmed

### 5.7.9.2 Input/Output Parameters

Input Element	GasSubmitRequestData
Input Schema	<pre> &lt;xsd:complexType name="GasSubmitRequestData"&gt;   &lt;xsd:complexContent&gt;     &lt;xsd:extension base="WholesaleSubmitRequestData"&gt;       &lt;xsd:choice&gt;         ...         &lt;xsd:element name="AgencyWithdrawnNominationConfirmed"           type="GasAgencyConfirmationType"/&gt;         ...       &lt;/xsd:choice&gt;       &lt;xsd:attribute         name="version"         type="r31"         use="optional"         default="r31"/&gt;       &lt;xsd:attribute         name="contextType"         type="GasSubmissionTransactionType"         use="required"/&gt;       &lt;xsd:attribute         name="applyTo"         type="GasSubmissionType"         use="optional"/&gt;     &lt;/xsd:extension&gt;   &lt;/xsd:complexContent&gt; &lt;/xsd:complexType&gt;           </pre>

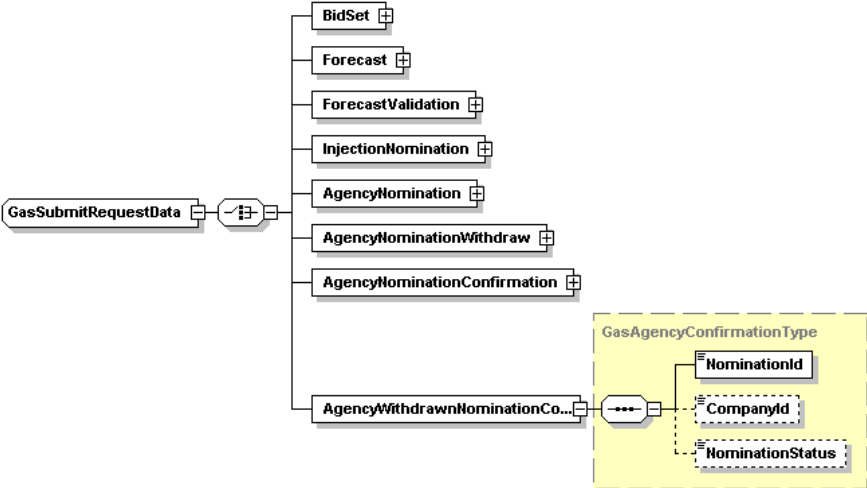
	
<p><b>Output Element</b></p>	<p>GasSubmitResponseData</p>
	<pre> &lt;xsd:complexType name="GasSubmitResponseData"&gt;   &lt;xsd:complexContent&gt;     &lt;xsd:extension base="WholesaleSubmitResponseData"&gt;       &lt;xsd:choice&gt;         ...         &lt;xsd:element name="AgencyWithdrawnNominationConfirmed"           type="GasAgencyConfirmationHeaderType"/&gt;         ...         &lt;xsd:element name="Success" type="xsd:boolean"/&gt;       &lt;/xsd:choice&gt;       &lt;xsd:attribute         name="version"         type="r31"         use="optional"         default="r31"/&gt;       &lt;xsd:attribute         name="contextType"         type="GasSubmissionTransactionType"         use="required"/&gt;       &lt;xsd:attribute         name="applyTo"         type="GasSubmissionType"         use="optional"/&gt;     &lt;/xsd:extension&gt;   &lt;/xsd:complexContent&gt; &lt;/xsd:complexType&gt;         </pre>

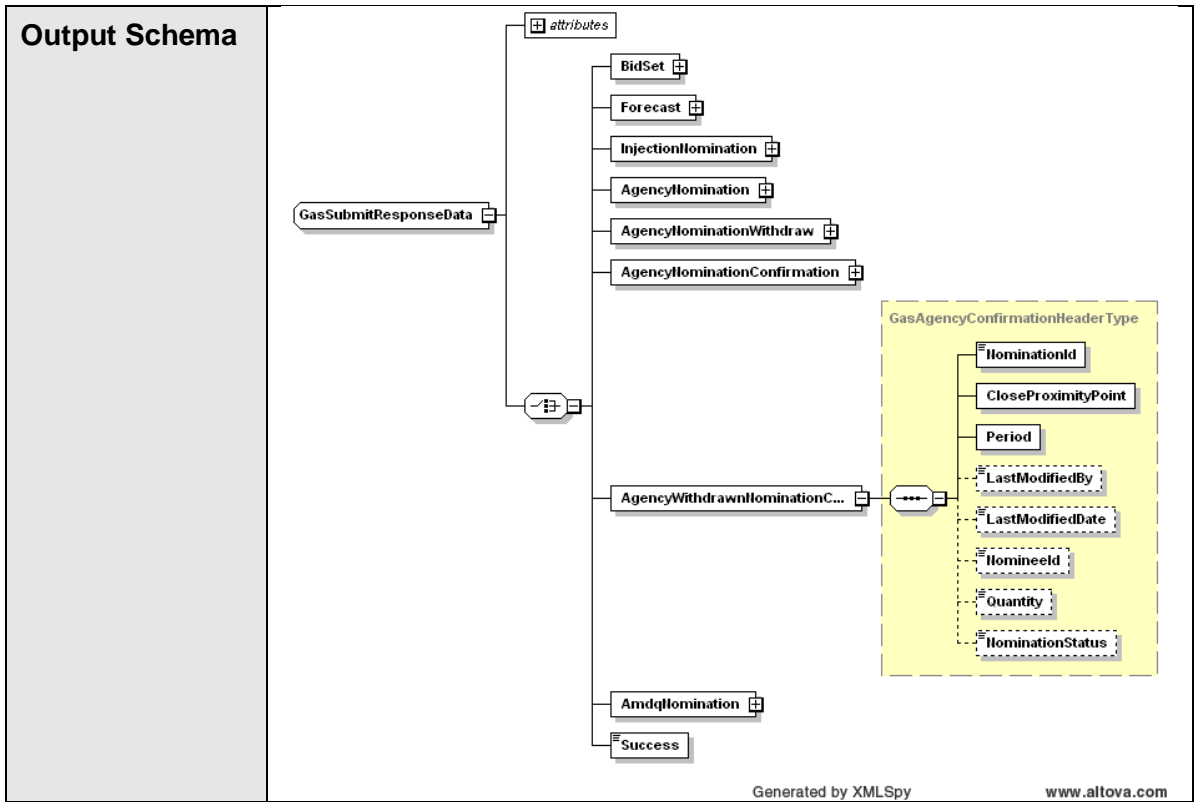

### 5.7.9.3 SOAP Faults

Fault Code	Fault Description
Global SOAP Faults	Refer to Global Fault Codes on page 61

### 5.7.9.4 Usage Examples

#### Request Sample

```

<ase:aseXML xmlns:ase="urn:aseXML:r31">
  <Header>
    <From>VENCorp WebExchanger Recipient</From>
    <To>VENCorp WebExchanger</To>
    <MessageID>06BD1F0E-B011-F839-74FF-F4094E70EB98</MessageID>
    <MessageDate>2006-06-22T11:47:04.878+10:00</MessageDate>
    <TransactionGroup>MKTW</TransactionGroup>
    <Priority>Medium</Priority>
    <Market>VICGAS</Market>
  </Header>
  <Transactions>
    <Transaction transactionID="06BD1F0E-B011-F839-74FF-F4094E70EB98"
      transactionDate="2006-06-22T11:47:04.878+10:00">
      <WholesaleSubmitRequest version="r20">
        <SubmitRequestData
          contextType="AgencyWithdrawnNominationConfirmed"
          xsi:type="urn:GasSubmitRequestData"
          xmlns:urn="urn:aseXML:r31"
          xmlns:xsi="http://www.w3.org/2001/XMLSchema-instance">
          <AgencyWithdrawnNominationConfirmed>
            <NominationId>40415</NominationId>
            <CompanyId>42</CompanyId>
            <NominationStatus>WCON</NominationStatus>
          </AgencyWithdrawnNominationConfirmed>
        </SubmitRequestData>
      </WholesaleSubmitRequest>
    </Transaction>
  </Transactions>
</ase:aseXML>

```

```

Response Sample
<ase:aseXML xmlns:ase="urn:aseXML:r31">
  <Header>
    <From>VENC Corp WebExchanger</From>
    <To>VENC Corp WebExchanger Recipient</To>
    <MessageID>8FEA5FE5-38C0-3DCF-9E71-C80A386CB2DC</MessageID>
    <MessageDate>2006-06-22T11:47:10.659+10:00</MessageDate>
    <TransactionGroup>MKTW</TransactionGroup>
    <Priority>Medium</Priority>
    <Market>VICGAS</Market>
  </Header>
  <Transactions>
    <Transaction transactionID="8FEA5FE5-38C0-3DCF-9E71-C80A386CB2DC"
      transactionDate="2006-06-22T11:47:10.659+10:00">
      <WholesaleSubmitResponse version="r20">
        <SubmitResponseData
          contextType="AgencyWithdrawnNominationConfirmed"
          xsi:type="urn:GasSubmitResponseData"
          xmlns:urn="urn:aseXML:r31"
          xmlns:xsi="http://www.w3.org/2001/XMLSchema-instance">
          <AgencyWithdrawnNominationConfirmed>
            <NominationId>40415</NominationId>
            <CloseProximityPoint>30000001PC</CloseProximityPoint>
            <Period>
              <BeginDate>2101-06-15+10:00</BeginDate>
              <EndDate>2101-06-20+10:00</EndDate>
            </Period>
            <LastModifiedBy>wextest2</LastModifiedBy>
            <LastModifiedDate>2006-06-22T11:47:09.793+10:00</LastModifiedDate>
            <NomineeId>5</NomineeId>
            <Quantity>1234</Quantity>
            <NominationStatus>WCON</NominationStatus>
          </AgencyWithdrawnNominationConfirmed>
        </SubmitResponseData>
      </WholesaleSubmitResponse>
    </Transaction>
  </Transactions>
</ase:aseXML>
    
```

### 5.7.10 GetAgencyConfirmationHeader

#### 5.7.10.1 Description

The `getAgencyConfirmationHeader()` operation is responsible for retrieval of the agency nomination status - actually the complete nomination only without the agency nomination header identifier - as per specified individual agency nomination id.

This operation shall be executed only by the nominee/agent.



Request Parameter:

Simple type	AgencyNominationId
-------------	--------------------

Request Attributes:

xsi:type	GasRetrieveRequestData
context	AgencyConfirmationHeader



Response Parameter:

Complex type	GasAgencyConfirmationHeaderType
--------------	---------------------------------

Response Attributes:

xsi:type	GasRetrieveResponseData
context	AgencyConfirmationHeader

### 5.7.10.2 Input/Output Parameters

Input Element	GasRetrieveRequestData
Input Schema	<pre> &lt;xsd:complexType name="GasRetrieveRequestData"&gt;   &lt;xsd:complexContent&gt;     &lt;xsd:extension base="WholesaleRetrieveRequestData"&gt;       &lt;xsd:choice&gt;         ...         &lt;xsd:element name="AgencyNominationId"           type="xsd:long"/&gt;         ...       &lt;/xsd:choice&gt;       &lt;xsd:attribute         name="version"         type="r30"         use="optional"         default="r30"/&gt;       &lt;xsd:attribute         name="ContextType"         type="GasRetrieveTransactionType"         use="required"/&gt;     &lt;/xsd:extension&gt;   &lt;/xsd:complexContent&gt; &lt;/xsd:complexType&gt; </pre>

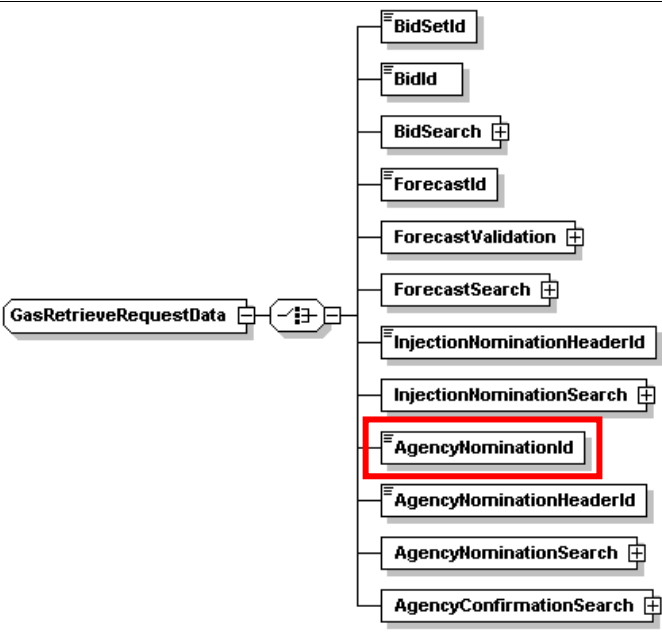
	
<b>Output Element</b>	GasRetrieveResponseData
	<pre> &lt;xsd:complexType name="GasRetrieveResponseData"&gt;   &lt;xsd:complexContent&gt;     &lt;xsd:extension base="WholesaleRetrieveResponseData"&gt;       &lt;xsd:sequence&gt;         &lt;xsd:choice&gt;           ...           &lt;xsd:element name="AgencyConfirmation"             type="GasAgencyConfirmationHeaderType"/&gt;           ...         &lt;/xsd:choice&gt;       &lt;/xsd:sequence&gt;       &lt;xsd:attribute         name="version"         type="r31"         use="optional"         default="r31"/&gt;       &lt;xsd:attribute         name="contextType"         type="GasRetrieveTransactionType"         use="required"/&gt;     &lt;/xsd:extension&gt;   &lt;/xsd:complexContent&gt; &lt;/xsd:complexType&gt;         </pre>

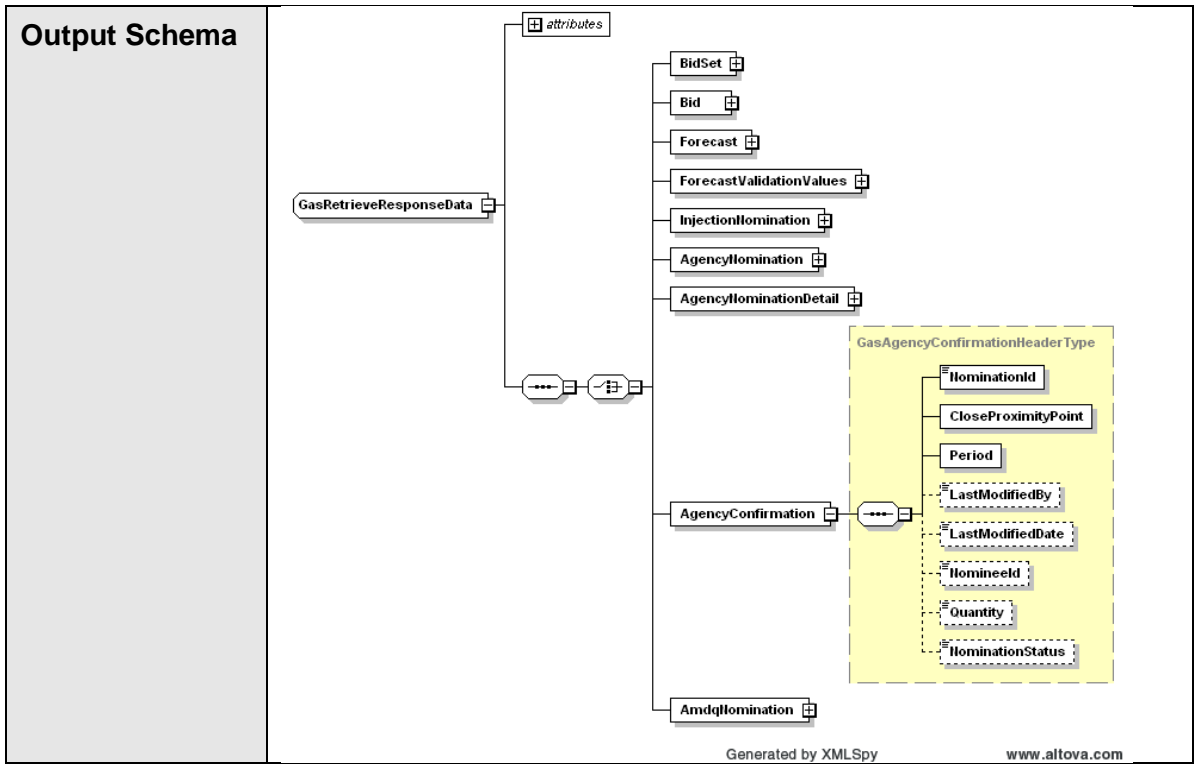

### 5.7.10.3 SOAP Faults

Fault Code	Fault Description
Global SOAP Faults	Refer to Global Fault Codes on page 61



### 5.7.10.4 Usage Examples

#### Request Sample

```
<ase:aseXML xmlns:ase="urn:aseXML:r31">
  <Header>
    <From>VENCorp WebExchanger Recipient</From>
    <To>VENCorp WebExchanger</To>
    <MessageID>DEC468C3-4BD8-F6DF-1F3F-50D7780A8D6E</MessageID>
    <MessageDate>2006-06-22T11:46:19.299+10:00</MessageDate>
    <TransactionGroup>MKTW</TransactionGroup>
    <Priority>Medium</Priority>
    <Market>VICGAS</Market>
  </Header>
  <Transactions>
    <Transaction transactionID="DEC468C3-4BD8-F6DF-1F3F-50D7780A8D6E"
      transactionDate="2006-06-22T11:46:19.299+10:00">
      <WholesaleRetrieveRequest version="r20">
        <RetrieveRequestData
          contextType="AgencyConfirmationHeader"
          xsi:type="urn:GasRetrieveRequestData"
          xmlns:urn="urn:aseXML:r31"
          xmlns:xsi="http://www.w3.org/2001/XMLSchema-instance">
          <AgencyNominationId>40415</AgencyNominationId>
        </RetrieveRequestData>
      </WholesaleRetrieveRequest>
    </Transaction>
  </Transactions>
</ase:aseXML>
```

#### Response Sample

```
<ase:aseXML xmlns:ase="urn:aseXML:r31">
  <Header>
    <From>VENCorp WebExchanger</From>
    <To>VENCorp WebExchanger Recipient</To>
    <MessageID>B1F47D92-82F5-0DA7-78BE-13DABA97AD69</MessageID>
    <MessageDate>2006-06-22T11:46:23.018+10:00</MessageDate>
    <TransactionGroup>MKTW</TransactionGroup>
    <Priority>Medium</Priority>
    <Market>VICGAS</Market>
  </Header>
  <Transactions>
    <Transaction transactionID="B1F47D92-82F5-0DA7-78BE-13DABA97AD69"
      transactionDate="2006-06-22T11:46:23.018+10:00">
      <WholesaleRetrieveResponse version="r20">
        <RetrieveResponseData
          contextType="AgencyConfirmationHeader"
          xsi:type="urn:GasRetrieveResponseData"
          xmlns:urn="urn:aseXML:r31"
          xmlns:xsi="http://www.w3.org/2001/XMLSchema-instance">
          <AgencyConfirmation>
            <NominationId>40415</NominationId>
            <CloseProximityPoint>30000001PC</CloseProximityPoint>
            <Period>
              <BeginDate>2101-06-15+10:00</BeginDate>
              <EndDate>2101-06-20+10:00</EndDate>
            </Period>
            <LastModifiedBy>wextest5</LastModifiedBy>
            <LastModifiedDate>2006-06-22T11:38:07.653+10:00</LastModifiedDate>
            <NomineeId>5</NomineeId>
            <Quantity>1234</Quantity>
            <NominationStatus>NWDN</NominationStatus>
          </AgencyConfirmation>
        </RetrieveResponseData>
      </WholesaleRetrieveResponse>
    </Transaction>
  </Transactions>
</ase:aseXML>
```



## 5.8 Web Service: AMDQ Nomination Service

### 5.8.1 Introduction

The AMDQ Nomination Service is responsible for all AMDQ-related functionality, including retrieving AMDQ nomination data and submitting new AMDQ nominations to the WebExchanger application.

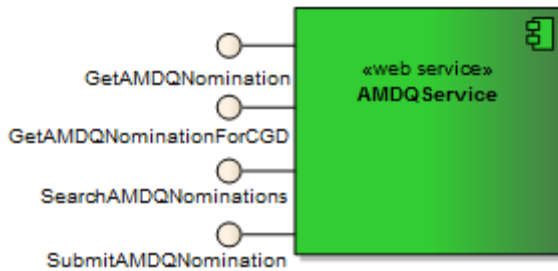

The service provides the following operations:

- GetAMDQNomination
- GetAMDQNominationForCGD
- SearchAMDQNominations
- SubmitAMDQNominations

Note: The sum of AMDQNominationGJ may not add up exactly to AvailableAMDQGJ in the response data of each AMDQ Service due to loss of precision while rounding up each AMDQNominationGJ value to 4 decimal places.

### 5.8.2 GetAMDQNomination

#### 5.8.2.1 Description

The `getAmdqNomination()` method obtains all the data for a particular AMDQ nomination based on its identifier (AMDQ Nomination Header Id). Only nominations submitted by the logged in user, or another user within the same company/organization, will be viewable using this method.

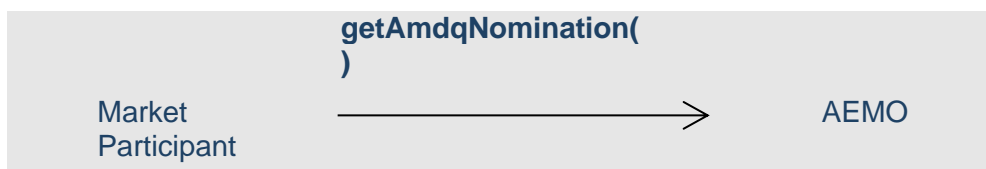

Request Parameter:

Simple type	AmdqNominationHeaderId
-------------	------------------------

Request Attributes:

xsi:type	GasRetrieveRequestData
context	AmdqNomination



Response Parameter:

Complex type	GasANType
--------------	-----------

Response Attributes:

xsi:type	GasRetrieveResponseData
context	AmdqNomination

### 5.8.2.2 Input/Output Parameters

Input Element	GasRetrieveRequestData
Input Schema	<pre> &lt;xsd:complexType name="GasRetrieveRequestData"&gt;   &lt;xsd:complexContent&gt;     &lt;xsd:extension base="WholesaleRetrieveRequestData"&gt;       &lt;xsd:choice&gt;         ...         &lt;xsd:element name="AmdqNominationHeaderId"           type="xsd:long"/&gt;         ...       &lt;/xsd:choice&gt;       &lt;xsd:attribute         name="version"         type="r30"         use="optional"         default="r30"/&gt;       &lt;xsd:attribute         name="contextType"         type="GasRetrieveTransactionType"         use="required"/&gt;     &lt;/xsd:extension&gt;   &lt;/xsd:complexContent&gt; &lt;/xsd:complexType&gt;           </pre>

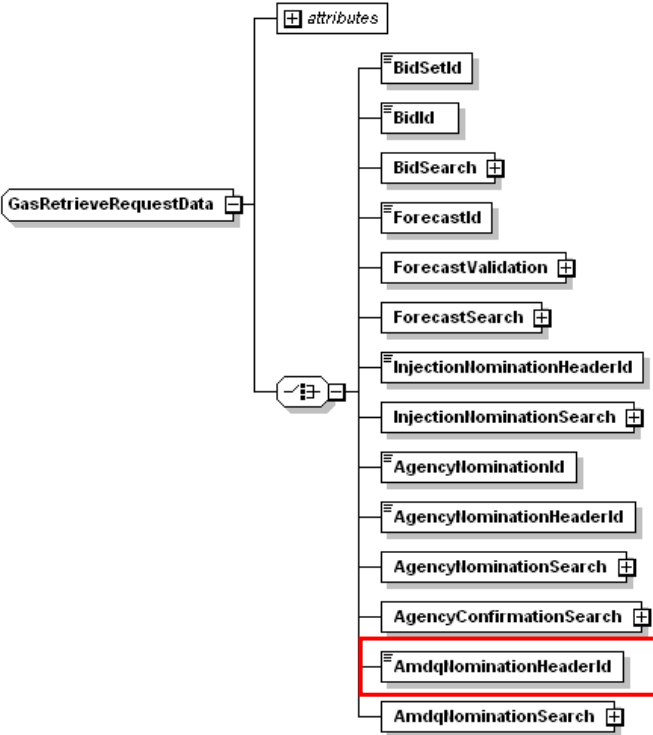
	 <p style="text-align: center;">Generated by XMLSpy <span style="float: right;">www.altova.com</span></p>
<b>Output Element</b>	GasRetrieveResponseData
	<pre> &lt;xsd:complexType name="GasRetrieveResponseData"&gt;   &lt;xsd:complexContent&gt;     &lt;xsd:extension base="WholesaleRetrieveResponseData"&gt;       &lt;xsd:sequence&gt;         &lt;xsd:choice&gt;           ...           &lt;xsd:element name="AmdqNomination" type="GasANType"/&gt;           ...         &lt;/xsd:choice&gt;       &lt;/xsd:sequence&gt;       &lt;xsd:attribute         name="version"         type="r31"         use="optional"         default="r31"/&gt;       &lt;xsd:attribute         name="contextType"         type="GasRetrieveTransactionType"         use="required"/&gt;     &lt;/xsd:extension&gt;   &lt;/xsd:complexContent&gt; &lt;/xsd:complexType&gt;         </pre>
<b>Output Schema</b>	

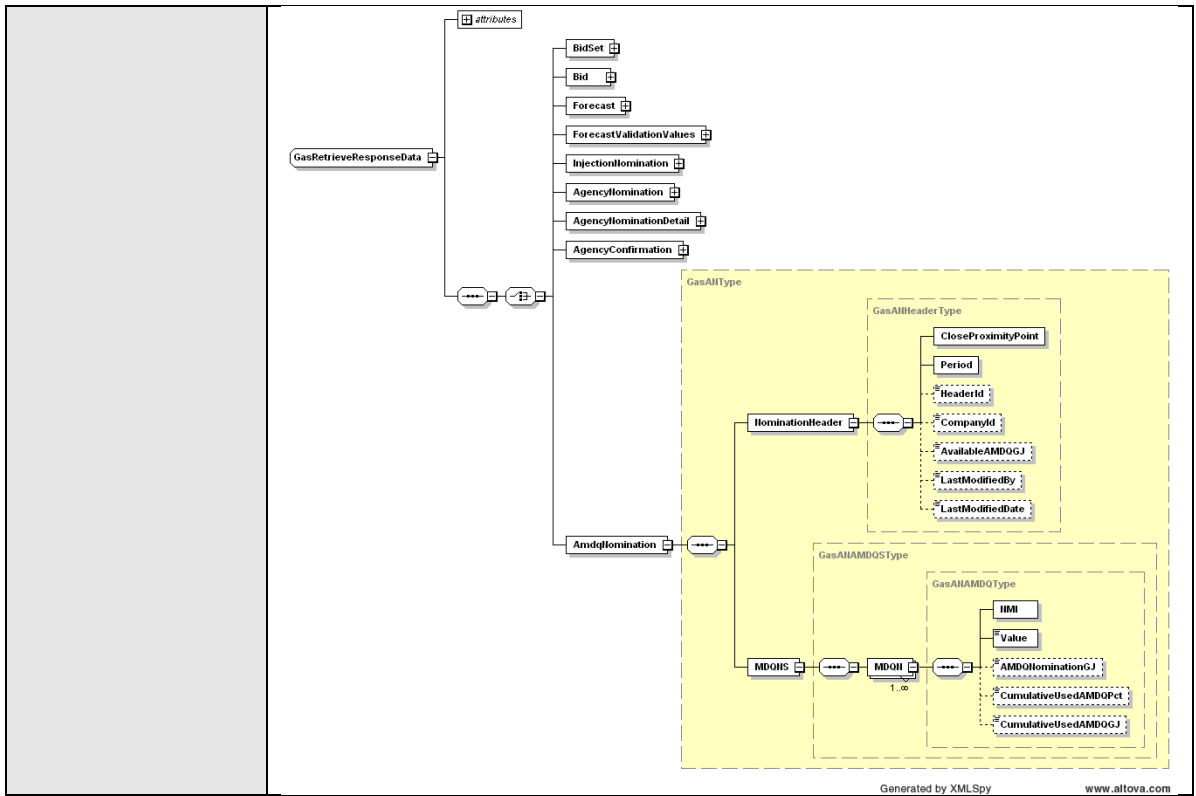

### 5.8.2.3 SOAP Faults

Fault Code	Fault Description
Global SOAP Faults	Refer to Global Fault Codes on page 49

### 5.8.2.4 Usage Examples

#### Request Sample

```
<ase:aseXML xmlns:ase="urn:aseXML:r31">
<Header>
  <From>VENCORP WebExchanger Recipient</From>
  <To>VENCORP WebExchanger</To>
  <MessageID>0FA49DA0-1FF0-CF91-89BD-A2ADFD17CCE8</MessageID>
  <MessageDate>2006-06-19T15:01:22.830+10:00</MessageDate>
  <TransactionGroup>MKTW</TransactionGroup>
  <Priority>Medium</Priority>
  <Market>VICGAS</Market>
</Header>
<Transactions>
  <Transaction transactionID="0FA49DA0-1FF0-CF91-89BD-A2ADFD17CCE8"
    transactionDate="2006-06-19T15:01:22.830+10:00">
    <WholesaleRetrieveRequest version="r20">
      <RetrieveRequestData
        contextType="AmdqNomination"
        xsi:type="urn:GasRetrieveRequestData"
        xmlns:urn="urn:aseXML:r31"
        xmlns:xsi="http://www.w3.org/2001/XMLSchema-instance">
        <AmdqNominationHeaderId>10000</AmdqNominationHeaderId>
      </RetrieveRequestData>
    </WholesaleRetrieveRequest>
  </Transaction>
</Transactions></ase:aseXML>
```

#### Response Sample

```
<ase:aseXML xmlns:ase="urn:aseXML:r31">
<Header>
  <From>VENCORP WebExchanger</From>
  <To>VENCORP WebExchanger Recipient</To>
  <MessageID>A0C6365B-2621-7DD6-4BDE-D3365311C834</MessageID>
  <MessageDate>2006-03-17T09:53:48.304+11:00</MessageDate>
  <TransactionGroup>MKTW</TransactionGroup>
  <Priority>Medium</Priority>
  <Market>VICGAS</Market>
</Header>
<Transactions>
  <Transaction transactionID="A0C6365B-2621-7DD6-4BDE-D3365311C834"
    transactionDate="2006-03-17T09:53:48.304+11:00">
    <WholesaleRetrieveResponse version="r20">
      <RetrieveResponseData contextType="AmdqNomination"
        xsi:type="urn:GasRetrieveResponseData"
        xmlns:urn="urn:aseXML:r31" version="r31">
        <AmdqNomination xsi:type="urn:GasANType">
          <NominationHeader>
            <CloseProximityPoint>3001111111</CloseProximityPoint>
            <Period>
              <BeginDate>2006-03-17+11:00</BeginDate>
              <EndDate>2006-03-25+11:00</EndDate>
            </Period>
            <HeaderId>12</HeaderId>
            <CompanyId>123</CompanyId>
          </NominationHeader>
          <MDQNS>
            <MDQN>
              <NMI>3001111111</NMI>
              <Value>20</Value>
            </MDQN>
          </MDQNS>
        </AmdqNomination>
      </RetrieveResponseData>
    </WholesaleRetrieveResponse>
  </Transaction>
</Transactions>
</ase:aseXML>
```

## 5.8.3 GetAMDQNominationForCGD

### 5.8.3.1 Description

The `getAmdqNominationForCGD()` method returns the AMDQ nomination that is effective for the current gas day. This is a convenience method as the same data can be obtained via the related Search AMDQ Nominations or Get AMDQ Nominations calls. Only nominations submitted by the logged in user, or another user within the same company/organization, will be viewable using this method.

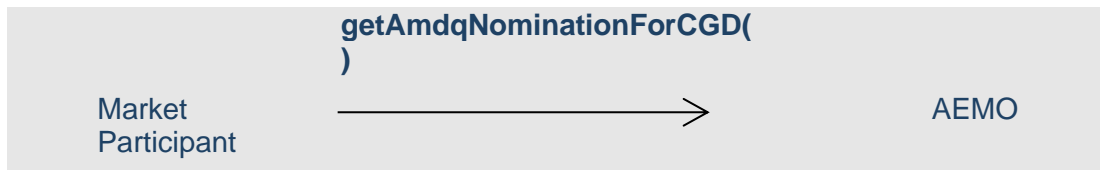

Request Parameter:

Complex type	AmdqNominationSearch
--------------	----------------------

Request Attributes:

xsi:type	GasRetrieveRequestData
context	AmdqNominationCGD



Response Parameter:

Complex type	GasANType
--------------	-----------

Response Attributes:

xsi:type	GasRetrieveResponseData
context	AmdqNomination

Note 1: In a request, if Period element is supplied, then it will be ignored.

Note 2: In a response, IntervalId with value of 1 corresponds to the first scheduling interval with published time of 6:00am.



5.8.3.2 Input/Output Parameters

<p><b>Input Element</b></p>	<p>GasRetrieveRequestData</p>
<p><b>Input Schema</b></p>	<pre> &lt;xsd:complexType name="GasRetrieveRequestData"&gt;   &lt;xsd:complexContent&gt;     &lt;xsd:extension base="WholesaleRetrieveRequestData"&gt;       &lt;xsd:choice&gt;         ...         &lt;xsd:element           name="AmdqNominationSearch"           type="GasAmdqNominationSearchType"/&gt;         ...       &lt;/xsd:choice&gt;     &lt;xsd:attribute       name="version"       type="r30"       use="optional"       default="r30"/&gt;     &lt;xsd:attribute       name="contextType"       type="GasRetrieveTransactionType"       use="required"/&gt;   &lt;/xsd:extension&gt; &lt;/xsd:complexContent&gt; &lt;/xsd:complexType&gt;         </pre> <p style="text-align: right;">Generated by XMLSpy <a href="http://www.altova.com">www.altova.com</a></p>
<p><b>Output Element</b></p>	<p>GasRetrieveResponseData</p> <pre> &lt;xsd:complexType name="GasRetrieveResponseData"&gt;   &lt;xsd:complexContent&gt;     &lt;xsd:extension base="WholesaleRetrieveResponseData"&gt;       &lt;xsd:sequence&gt;         &lt;xsd:choice&gt;           ...           &lt;xsd:element name="AmdqNomination" type="GasANType"/&gt;         &lt;/xsd:choice&gt;       &lt;/xsd:sequence&gt;     &lt;/xsd:extension&gt;   &lt;/xsd:complexContent&gt; &lt;/xsd:complexType&gt;         </pre>

```

        ...
    </xsd:choice>
</xsd:sequence>
<xsd:attribute
    name="version"
    type="r31"
    use="optional"
    default="r31"/>
<xsd:attribute
    name="contextType"
    type="GasRetrieveTransactionType"
    use="required"/>
</xsd:extension>
</xsd:complexContent>
</xsd:complexType>
    
```

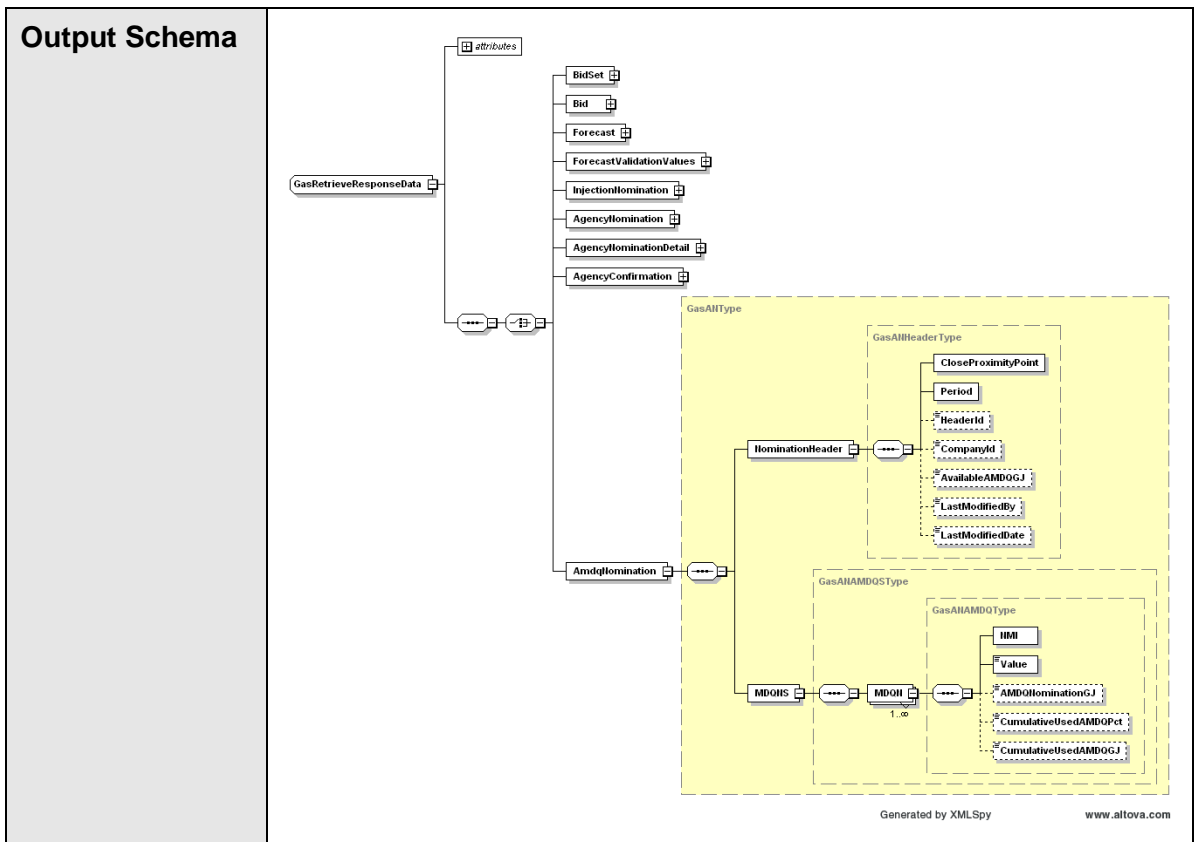

**5.8.3.3 SOAP Faults**

Fault Code	Fault Description
Global SOAP Faults	Refer to Global Fault Codes on page 49

### 5.8.3.4 Usage Examples

#### Request Sample

```
<ase:aseXML xmlns:ase="urn:aseXML:r31">
<Header>
<From>VENCorp WebExchanger Recipient</From>
<To>VENCorp WebExchanger</To>
<MessageID>979A027E-B795-523D-EC70-16E87CD0425A</MessageID>
<MessageDate>2006-03-17T09:46:54.273+11:00</MessageDate>
<TransactionGroup>MKTW</TransactionGroup>
<Priority>Medium</Priority>
<Market>VICGAS</Market>
</Header>
<Transactions>
<Transaction transactionID="979A027E-B795-523D-EC70-16E87CD0425A"
transactionDate="2006-03-17T09:46:54.273+11:00">
<WholesaleRetrieveRequest version="r20">
<RetrieveRequestData version="r30" contextType="AmdqNominationCGD"
xsi:type="urn:GasRetrieveRequestData" xmlns:urn="urn:aseXML:r31"
xmlns:xsi="http://www.w3.org/2001/XMLSchema-instance">
<AmdqNominationSearch>
<CloseProximityPoint>30000001PC</CloseProximityPoint>
<Period>
<BeginDate>2006-03-17+11:00</BeginDate>
<EndDate>2006-03-18+11:00</EndDate>
</Period>
</AmdqNominationSearch>
</RetrieveRequestData>
</WholesaleRetrieveRequest>
</Transaction>
</Transactions>
</ase:aseXML>
```

#### Response Sample

```
<ase:aseXML xmlns:ase="urn:aseXML:r31">
<Header>
<From>VENCorp WebExchanger</From>
<To>VENCorp WebExchanger Recipient</To>
<MessageID>A0C6365B-2621-7DD6-4BDE-D3365311C834</MessageID>
<MessageDate>2006-03-17T09:53:48.304+11:00</MessageDate>
<TransactionGroup>MKTW</TransactionGroup>
<Priority>Medium</Priority>
<Market>VICGAS</Market>
</Header>
<Transactions>
<Transaction transactionID="A0C6365B-2621-7DD6-4BDE-D3365311C834"
transactionDate="2006-03-17T09:53:48.304+11:00">
<WholesaleRetrieveResponse version="r20">
<RetrieveResponseData contextType="AmdqNomination"
xsi:type="urn:GasRetrieveResponseData" xmlns:urn="urn:aseXML:r31" version="r31">
<AmdqNomination xsi:type="urn:GasANType">
<NominationHeader>
<CloseProximityPoint>3001111111</CloseProximityPoint>
<Period>
<BeginDate>2006-03-17+11:00</BeginDate>
<EndDate>2006-03-18+11:00</EndDate>
</Period>
<HeaderId>12</HeaderId>
<CompanyId>123</CompanyId>
<AvailableAMDQGJ>20.1111</AvailableAMDQGJ>
</NominationHeader>
<MDQNS>
<MDQN>
<NMI>3001111111</NMI>
<Value>20</Value>
<AMDQNominationGJ>20.2233</AMDQNominationGJ>
<CumulativeUsedAMDQPct>123.2354</CumulativeUsedAMDQPct>
<CumulativeUsedAMDQGJ>13.2354</CumulativeUsedAMDQGJ>
```

```

</MDQN>
</MDQNS>
</AmdqNomination>
</RetrieveResponseData>
</WholesaleRetrieveResponse>
</Transaction>
</Transactions>
</ase:aseXML>
    
```

## 5.8.4 SearchAMDQNominations

### 5.8.4.1 Description

The searchAmdqNominations() operation is responsible for the retrieval of AMDQ nominations whose effective dates fall completely within the specified search period or partially overlap the specified search period.

For example, the following combinations of search period Begin and End dates could be used to retrieve a standing nomination which runs from 1/2/2012 to 10/2/2012:

- Begin Date = 1/2/2012 and End Date = 10/2/2012
- Begin Date = 30/1/2012 and End Date = 11/2/2012
- Begin Date = 30/1/2012 and End Date = 2/2/2012
- Begin Date = 4/2/2012 and End Date = 13/2/2012

Only nominations submitted by the logged in user, or another user within the same company/organization, will be viewable using this method.

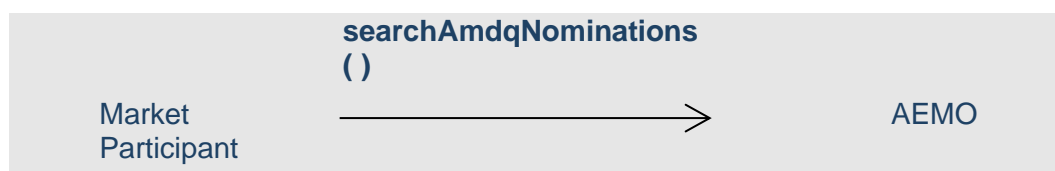

Request Parameter:

Complex type	AmdqNominationSearch
--------------	----------------------

Request Attributes:

xsi:type	GasSearchRequestData
context	AmdqNomination

**response**

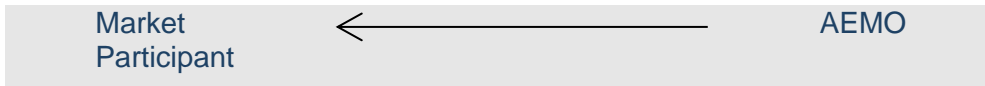

Response Parameter:

Complex type	AmdqNominations
--------------	-----------------

Response Attributes:

xsi:type	GasSearchResponseData
context	AmdqNomination

### 5.8.4.2 Input/Output Parameters

<b>Input Element</b>	GasSearchRequestData
<b>Input Schema</b>	<pre>&lt;xsd:complexType name="GasSearchRequestData"&gt;   &lt;xsd:complexContent&gt;     &lt;xsd:extension base="WholesaleSearchRequestData"&gt;       &lt;xsd:choice&gt;         ...         &lt;xsd:element           name="AmdqNominationSearch"           type="GasAmdqNominationSearchType"/&gt;         ...       &lt;/xsd:choice&gt;       &lt;xsd:attribute         name="version"         type="r30"         use="optional"         default="r30"/&gt;       &lt;xsd:attribute         name="ContextType"         type="GasSearchTransactionType"         use="required"/&gt;     &lt;/xsd:extension&gt;   &lt;/xsd:complexContent&gt; &lt;/xsd:complexType&gt;</pre> <p style="text-align: right;">Generated by XMLSpy <a href="http://www.altova.com">www.altova.com</a></p>
<b>Output Element</b>	GasSearchResponseData
	<pre>&lt;xsd:complexType name="GasSearchResponseData"&gt;   &lt;xsd:complexContent&gt;</pre>

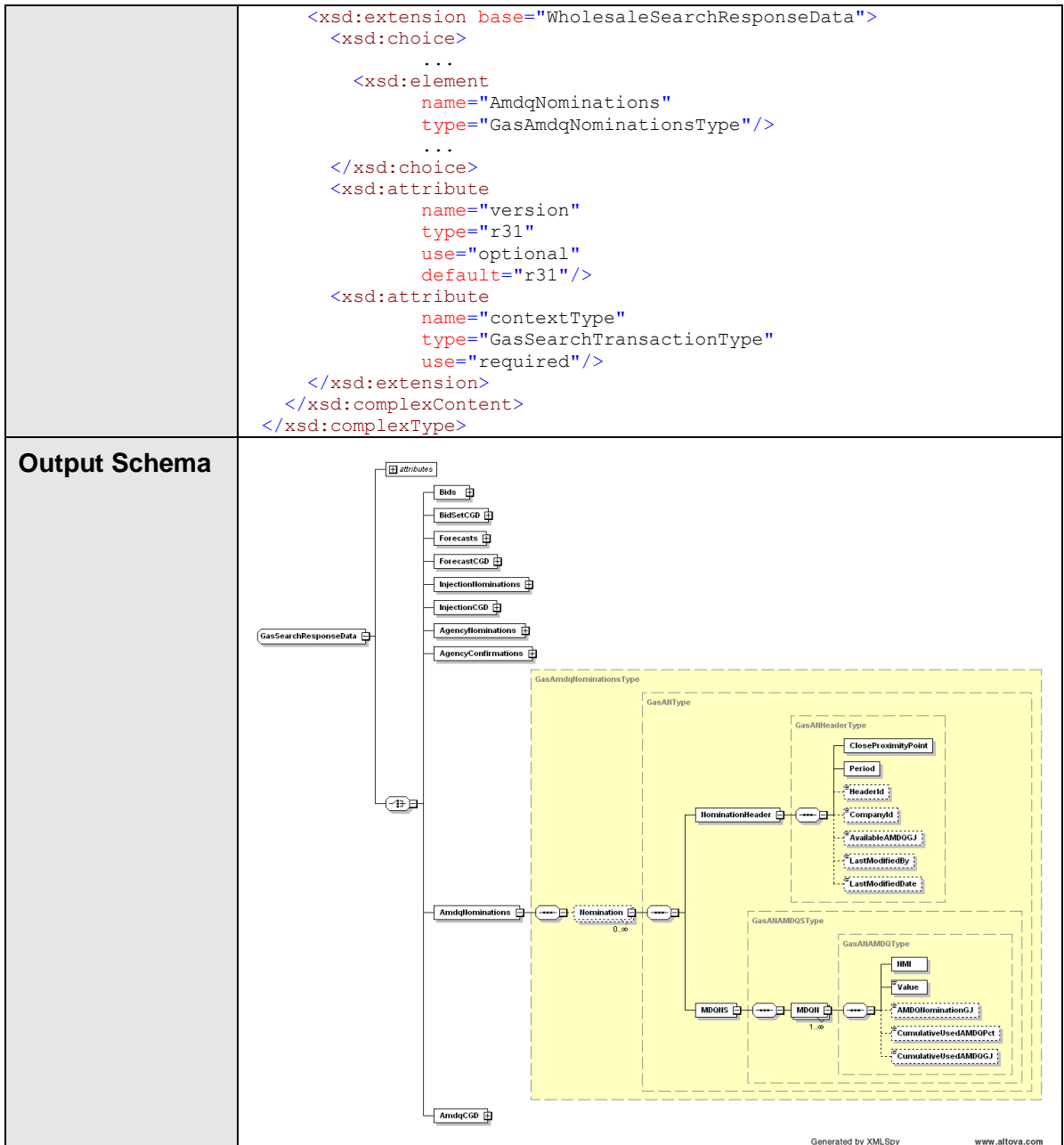

**5.8.4.3 SOAP Faults**

Fault Code	Fault Description
Global SOAP Faults	Refer to Global Fault Codes on page 49

#### 5.8.4.4 Usage Examples

##### Request Sample

```
<ase:aseXML xmlns:ase="urn:aseXML:r31">
<Header>
  <From>VENCorp WebExchanger Recipient</From>
  <To>VENCorp WebExchanger</To>
  <MessageID>957EC009-0C4F-26B8-6CB4-F056AF68BBAA</MessageID>
  <MessageDate>2006-06-19T14:55:21.098+10:00</MessageDate>
  <TransactionGroup>MKTW</TransactionGroup>
  <Priority>Medium</Priority>
  <Market>VICGAS</Market>
</Header>
<Transactions>
  <Transaction transactionID="957EC009-0C4F-26B8-6CB4-F056AF68BBAA"
transactionDate="2006-06-19T14:55:21.098+10:00">
    <WholesaleSearchRequest version="r20">
      <SearchRequestData contextType="AmdqNomination"
xsi:type="urn:GasSearchRequestData" xmlns:urn="urn:aseXML:r31">
        <AmdqNominationSearch>
          <CloseProximityPoint>30000001PC</CloseProximityPoint>
          <Period>
            <BeginDate>2006-06-19+10:00</BeginDate>
            <EndDate>2006-06-23+10:00</EndDate>
          </Period>
        </AmdqNominationSearch>
      </SearchRequestData>
    </WholesaleSearchRequest>
  </Transaction>
</Transactions>
</ase:aseXML>
```

##### Response Sample

```
<ase:aseXML xmlns:ase="urn:aseXML:r31">
<Header>
  <From>VENCorp WebExchanger</From>
  <To>VENCorp WebExchanger Recipient</To>
  <MessageID>64380B73-DBC4-F97C-8B0E-D8E09214A298</MessageID>
  <MessageDate>2006-06-19T14:55:35.676+10:00</MessageDate>
  <TransactionGroup>MKTW</TransactionGroup>
  <Priority>Medium</Priority>
  <Market>VICGAS</Market>
</Header>
<Transactions>
  <Transaction transactionID="64380B73-DBC4-F97C-8B0E-D8E09214A298"
transactionDate="2006-06-19T14:55:35.676+10:00">
    <WholesaleSearchResponse version="r20">
      <SearchResponseData contextType="AmdqNomination"
xsi:type="urn:GasSearchResponseData" xmlns:urn="urn:aseXML:r31">
        <AmdqNominations>
          <Nomination>
            <NominationHeader>
              <CloseProximityPoint>30000001PC</CloseProximityPoint>
              <Period>
                <BeginDate>2006-06-15+10:00</BeginDate>
                <EndDate>2006-06-21+10:00</EndDate>
              </Period>
              <CompanyId>5</CompanyId>
            </NominationHeader>
            <MDQNS>
              <MDQN>
                <NMI>3001111111</NMI>
                <Value>20</Value>
              </MDQN>
            </MDQNS>
          </Nomination>
          <Nomination>
            <NominationHeader>
```

```

<CloseProximityPoint>30000002PC</CloseProximityPoint>
<Period>
  <BeginDate>2006-06-18+10:00</BeginDate>
  <EndDate>2006-06-28+10:00</EndDate>
</Period>
<CompanyId>5</CompanyId>
</NominationHeader>
<MDQNS>
  <MDQN>
    <NMI>3001111118</NMI>
    <Value>20</Value>
  </MDQN>
</MDQNS>
</Nomination>
<Nomination>
  <NominationHeader>
    <CloseProximityPoint>30000003PC</CloseProximityPoint>
    <Period>
      <BeginDate>2006-06-16+10:00</BeginDate>
      <EndDate>2006-06-22+10:00</EndDate>
    </Period>
    <CompanyId>5</CompanyId>
  </NominationHeader>
  <MDQNS>
    <MDQN>
      <NMI>3001111122</NMI>
      <Value>20</Value>
    </MDQN>
    <MDQN>
      <NMI>3001111123</NMI>
      <Value>410</Value>
    </MDQN>
    <MDQN>
      <NMI>3001111127</NMI>
      <Value>500</Value>
    </MDQN>
  </MDQNS>
</Nomination>
</AmdqNominations>
</SearchResponseData>
</WholesaleSearchResponse>
</Transaction>
</Transactions>
</ase:aseXML>

```

## 5.8.5 SubmitAMDQNomination

### 5.8.5.1 Description

The submitAmdqNomination() operation submits AMDQ nomination information for processing by the Web Exchanger application, using the supplied date range, CPP and other information related to NMI's associated with this CPP.

Only nominations submitted by the logged in user, or another user within the same company/organization, will be viewable using this method.

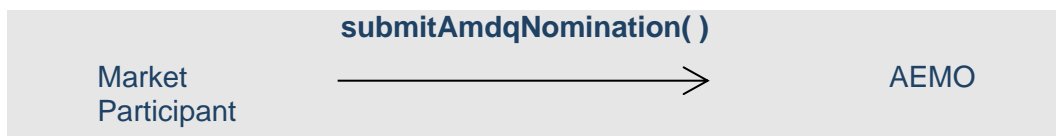



## Request Parameter:

Complex type	AmdqNomination
--------------	----------------

## Request Attributes:

xsi:type	GasSubmitRequestData
context	AmdqNomination
applyTo	GasSubmissionType



## Response Parameter:

Complex type	AmdqNomination
--------------	----------------

## Response Attributes:

xsi:type	GasSubmitResponseData
context	AmdqNomination
applyTo	GasSubmissionType

Note 1: In the request, if optional applyTo attribute is provided for current gas day, day ahead or two days ahead submission, then any values specified in the Period element will be ignored. The submission period will be automatically calculated by WebExchanger based on the current time. It is recommended that the applyTo attribute to be used for this type of the submission.

Note 2: In the request, if applyTo is set to “Standing”, then the Period element must be populated with the correct values. The Period’s EndDate (a.k.a. termination date) must be at least one day ahead of BeginDate. The EndDate is not inclusive.

Note 3: The element Value of AMDNominationGJ should not exceed 4 digits after the decimal point.

### 5.8.5.2 Input/Output Parameters

<b>Input Element</b>	GasSubmitRequestData
----------------------	----------------------

<p><b>Input Schema</b></p>	<pre> &lt;xsd:complexType name="GasSubmitRequestData"&gt;   &lt;xsd:complexContent&gt;     &lt;xsd:extension base="WholesaleSubmitRequestData"&gt;       &lt;xsd:choice&gt;         ...         &lt;xsd:element name="AmdqNomination" type="GasANType"/&gt;         ...       &lt;/xsd:choice&gt;       &lt;xsd:attribute         name="version"         type="r31"         use="optional"         default="r31"/&gt;       &lt;xsd:attribute         name="contextType"         type="GasSubmissionTransactionType"         use="required"/&gt;       &lt;xsd:attribute         name="applyTo"         type="GasSubmissionType"         use="optional"/&gt;     &lt;/xsd:extension&gt;   &lt;/xsd:complexContent&gt; &lt;/xsd:complexType&gt; </pre> <p style="text-align: right; font-size: small;">Generated by XMLSpy <a href="http://www.altova.com">www.altova.com</a></p>
<p><b>Output Element</b></p>	<p><b>GasSubmitResponseData</b></p> <pre> &lt;xsd:complexType name="GasSubmitResponseData"&gt;   &lt;xsd:complexContent&gt;     &lt;xsd:extension base="WholesaleSubmitResponseData"&gt;       &lt;xsd:choice&gt;         ...         &lt;xsd:element name="AmdqNomination" type="GasANType"/&gt;         ...       &lt;/xsd:choice&gt;       &lt;xsd:attribute         name="version" </pre>

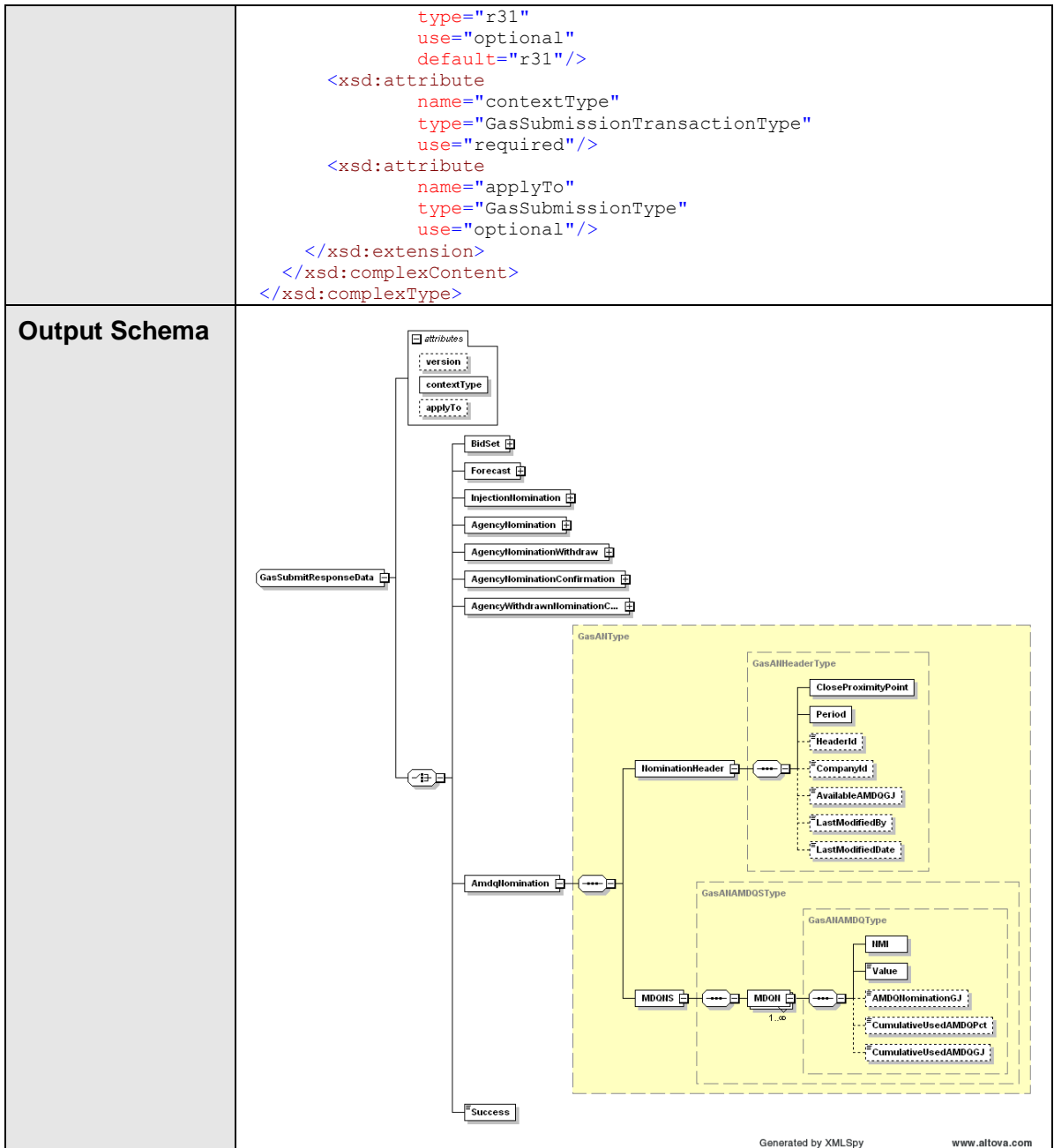

### 5.8.5.3 SOAP Faults

Fault Code	Fault Description
Global SOAP Faults	Refer to Global Fault Codes on page 49
3901	Invalid AMDQ Nomination percentage values supplied - values must be less than or equal to 100.
3902	Supplied nomination values must be equal to or greater than cumulative used percentage.

### 5.8.5.4 Usage Examples

Request Sample
<pre> &lt;ase:aseXML xmlns:ase="urn:aseXML:r31"&gt; &lt;Header&gt;   &lt;From&gt;VENCorp WebExchanger Recipient&lt;/From&gt;   &lt;To&gt;VENCorp WebExchanger&lt;/To&gt;   &lt;MessageID&gt;45CFFD39-0BE8-FAE5-4399-5A1C10A32569&lt;/MessageID&gt;   &lt;MessageDate&gt;2006-06-19T16:26:50.375+10:00&lt;/MessageDate&gt;   &lt;TransactionGroup&gt;MKTW&lt;/TransactionGroup&gt;   &lt;Priority&gt;Medium&lt;/Priority&gt;   &lt;Market&gt;VICGAS&lt;/Market&gt; &lt;/Header&gt; &lt;Transactions&gt;   &lt;Transaction transactionID="45CFFD39-0BE8-FAE5-4399-5A1C10A32569" transactionDate="2006-06-19T16:26:50.375+10:00"&gt;     &lt;WholesaleSubmitRequest version="r20"&gt;       &lt;SubmitRequestData contextType="AmdqNomination" applyTo="Standing" xsi:type="urn:GasSubmitRequestData" xmlns:urn="urn:aseXML:r31"&gt;         &lt;AmdqNomination&gt;           &lt;NominationHeader&gt;             &lt;CloseProximityPoint&gt;3001111111&lt;/CloseProximityPoint&gt;             &lt;Period&gt;               &lt;BeginDate&gt;2007-05-01+10:00&lt;/BeginDate&gt;               &lt;EndDate&gt;2007-07-04+10:00&lt;/EndDate&gt;             &lt;/Period&gt;             &lt;HeaderId&gt;12&lt;/HeaderId&gt;             &lt;CompanyId&gt;123&lt;/CompanyId&gt;           &lt;/NominationHeader&gt;           &lt;MDQNS&gt;             &lt;MDQN&gt;               &lt;NMI&gt;30011111PC&lt;/NMI&gt;               &lt;Value&gt;20&lt;/Value&gt;             &lt;/MDQN&gt;             &lt;MDQN&gt;               &lt;NMI&gt;30011112PC&lt;/NMI&gt;               &lt;Value&gt;410&lt;/Value&gt;             &lt;/MDQN&gt;             &lt;MDQN&gt;               &lt;NMI&gt;26211111PC&lt;/NMI&gt;               &lt;Value&gt;500&lt;/Value&gt;             &lt;/MDQN&gt;           &lt;/MDQNS&gt;         &lt;/AmdqNomination&gt;       &lt;/SubmitRequestData&gt;     &lt;/WholesaleSubmitRequest&gt;   &lt;/Transaction&gt; &lt;/Transactions&gt; &lt;/ase:aseXML&gt; </pre>

Response Sample
<pre> &lt;ase:aseXML xmlns:ase="urn:aseXML:r31"&gt; &lt;Header&gt;   &lt;From&gt;VENCorp WebExchanger Recipient&lt;/From&gt;   &lt;To&gt;VENCorp WebExchanger&lt;/To&gt;   &lt;MessageID&gt;45CFFD39-0BE8-FAE5-4399-5A1C10A32569&lt;/MessageID&gt;   &lt;MessageDate&gt;2006-06-19T16:26:50.375+10:00&lt;/MessageDate&gt;   &lt;TransactionGroup&gt;MKTW&lt;/TransactionGroup&gt;   &lt;Priority&gt;Medium&lt;/Priority&gt;   &lt;Market&gt;VICGAS&lt;/Market&gt; &lt;/Header&gt; &lt;Transactions&gt;   &lt;Transaction transactionID="45CFFD39-0BE8-FAE5-4399-5A1C10A32569" transactionDate="2006-06-19T16:26:50.375+10:00"&gt;     &lt;WholesaleSubmitResponse version="r20"&gt; </pre>

```
<SubmitResponseData contextType="AmdqNomination" applyTo="Standing"
xsi:type="urn:GasSubmitResponseData" xmlns:urn="urn:aseXML:r31">
  <AmdqNomination>
    <NominationHeader>
      <CloseProximityPoint>30000001PC</CloseProximityPoint>
      <Period>
        <BeginDate>2006-06-15+10:00</BeginDate>
        <EndDate>2006-06-21+10:00</EndDate>
      </Period>
      <CompanyId>5</CompanyId>
    </NominationHeader>
    <MDQNS>
      <MDQN>
        <NMI>3001111111</NMI>
        <Value>20</Value>
      </MDQN>
      <MDQN>
        <NMI>3001111118</NMI>
        <Value>20</Value>
      </MDQN>
      <MDQN>
        <NMI>3001111122</NMI>
        <Value>20</Value>
      </MDQN>
      <MDQN>
        <NMI>3001111123</NMI>
        <Value>410</Value>
      </MDQN>
      <MDQN>
        <NMI>3001111127</NMI>
        <Value>500</Value>
      </MDQN>
    </MDQNS>
  </AmdqNomination>
</SubmitResponseData>
</WholesaleSubmitResponse>
</Transaction>
</Transactions>
</ase:aseXML>
```

## 5.9 Web Service: System Service

### 5.9.1 Introduction

The System Service is responsible for all general purpose utility functions and functionality, which does not fall strictly into one of the other functional areas. Functionality provided includes the ability to get the current gas date and time from the AEMO system, as well as information such as scheduling intervals and so on.

### 5.9.2 GetCurrentGasDate

#### 5.9.2.1 Description

The `getCurrentGasDate()` method retrieves the current gas day date from the AEMO system.



Request Parameter:

Simple type	N/A
-------------	-----

Request Attributes:

xsi:type	GasInformationRequestData
context	CGD



Response Parameter:

Simple type	xsd:dateTime
-------------	--------------

Response Attributes:

xsi:type	GasInformationResponseData
context	CGD

Note 1: In the response, only date component of the `xsd:dateTime` type will be set. The time component shall be ignored.

#### 5.9.2.2 Input/Output Parameters

<b>Input Element</b>	GasInformationRequestData
<b>Input Schema</b>	<pre> &lt;xsd:complexType name="GasInformationRequestData"&gt;   &lt;xsd:complexContent&gt;     &lt;xsd:extension base="WholesaleInformationRequestData"&gt;       &lt;xsd:attribute         name="version"       /&gt;     /&gt;   /&gt;   /&gt; </pre>

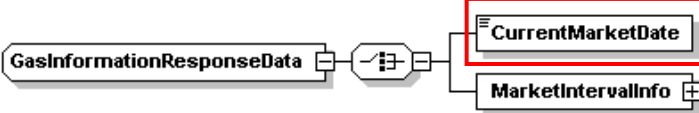
	<pre>                     type="r30"                     use="optional"                     default="r30"/&gt;                 &lt;xsd:attribute                     name="contextType"                     type="GasInformationTransactionType"                     use="required"/&gt;             &lt;/xsd:extension&gt;         &lt;/xsd:complexContent&gt;     &lt;/xsd:complexType&gt;                 </pre>
	
<b>Output Element</b>	GasInformationResponseData
<b>Output Schema</b>	<pre> &lt;xsd:complexType name="GasInformationResponseData"&gt; &lt;xsd:complexContent&gt; &lt;xsd:extension base="WholesaleInformationResponseData"&gt; &lt;xsd:choice&gt; ... &lt;xsd:element name="CurrentMarketDate"               type="xsd:dateTime"/&gt; ... &lt;/xsd:choice&gt; &lt;xsd:attribute     name="version"     type="r30"     use="optional"     default="r30"/&gt; &lt;xsd:attribute     name="contextType"     type="GasInformationTransactionType"     use="required"/&gt; &lt;/xsd:extension&gt; &lt;/xsd:complexContent&gt; &lt;/xsd:complexType&gt;                 </pre>
	

**5.9.2.3 SOAP Faults**

Fault Code	Fault Description
Global SOAP Faults	Refer to Global Fault Codes on page 61

### 5.9.2.4 Usage example

#### Request Sample

```
<ase:aseXML xmlns:ase="urn:aseXML:r31">
  <Header>
    <From>VENCorp WebExchanger Recipient</From>
    <To>VENCorp WebExchanger</To>
    <MessageID>7776454C-DE14-C88B-7255-DA6005F43272</MessageID>
    <MessageDate>2006-03-17T16:17:26.588+10:00</MessageDate>
    <TransactionGroup>MKTW</TransactionGroup>
    <Priority>Medium</Priority>
    <Market>VICGAS</Market>
  </Header>
  <Transactions>
    <Transaction transactionID="7776454C-DE14-C88B-7255-DA6005F43272"
      transactionDate="2006-03-17T16:17:26.588+10:00">
      <WholesaleInformationRequest version="r20">
        <InformationRequestData
          contextType="CGD"
          xsi:type="urn:GasInformationRequestData"
          xmlns:urn="urn:aseXML:r31"/
          xmlns:xsi="http://www.w3.org/2001/XMLSchema-instance">
        </WholesaleInformationRequest>
      </Transaction>
    </Transactions>
  </ase:aseXML>
```

#### Response Sample

```
<ase:aseXML xmlns:ase="urn:aseXML:r31">
  <Header>
    <From>VENCorp WebExchanger</From>
    <To>VENCorp WebExchanger Recipient</To>
    <MessageID>8585A887-20F2-A673-031E-EE3B26B95772</MessageID>
    <MessageDate>2006-03-17T16:17:36.275+10:00</MessageDate>
    <TransactionGroup>MKTW</TransactionGroup>
    <Priority>Medium</Priority>
    <Market>VICGAS</Market>
  </Header>
  <Transactions>
    <Transaction transactionID="8585A887-20F2-A673-031E-EE3B26B95772"
      transactionDate="2006-03-17T16:17:36.275+10:00">
      <WholesaleInformationResponse version="r20">
        <InformationResponseData
          contextType="CGD"
          xsi:type="urn:GasInformationResponseData"
          xmlns:urn="urn:aseXML:r30"
          xmlns:xsi="http://www.w3.org/2001/XMLSchema-instance">
          <CurrentMarketDate>2006-03-17T00:00:00.000+10:00</CurrentMarketDate>
        </InformationResponseData>
      </WholesaleInformationResponse>
    </Transaction>
  </Transactions>
</ase:aseXML>
```

## 5.9.3 GetIntervalInfo

### 5.9.3.1 Description

The `getIntervalInfo()` method retrieves the information about the current scheduling interval and the next scheduling interval as calculated by the AEMO gas



market systems. The calculations will be based on the AEMO’s server time. The calculation algorithm will use the same logic as utilised for populating and verification of submission screens via browser based interface.



Request Parameter:

Simple type	N/A
-------------	-----

Request Attributes:

xsi:type	GasInformationRequestData
context	IntervallInfo



Response Parameter:

Complex type	MarketIntervallInfoType
--------------	-------------------------

Response Attributes:

xsi:type	GasInformationResponseData
context	IntervallInfo

Note 1: The intervals will be returned only for the Current Gas Day, i.e. day ahead and two days ahead intervals are not returned by this operation.

### 5.9.3.2 Input/Output Parameters

<b>Input Element</b>	GasInformationRequestData
<b>Input Schema</b>	<pre> &lt;xsd:complexType name="GasInformationRequestData"&gt;   &lt;xsd:complexContent&gt;     &lt;xsd:extension base="WholesaleInformationRequestData"&gt;       &lt;xsd:attribute         name="version"         type="r30"         use="optional"         default="r30"/&gt;       &lt;xsd:attribute         name="contextType"         type="GasInformationTransactionType"         use="required"/&gt;     &lt;/xsd:extension&gt;   &lt;/xsd:complexContent&gt; &lt;/xsd:complexType&gt;                 </pre>
	<div style="border: 1px solid black; padding: 2px; display: inline-block;"> <b>GasInformationRequestData</b> </div>
<b>Output Element</b>	GasInformationResponseData

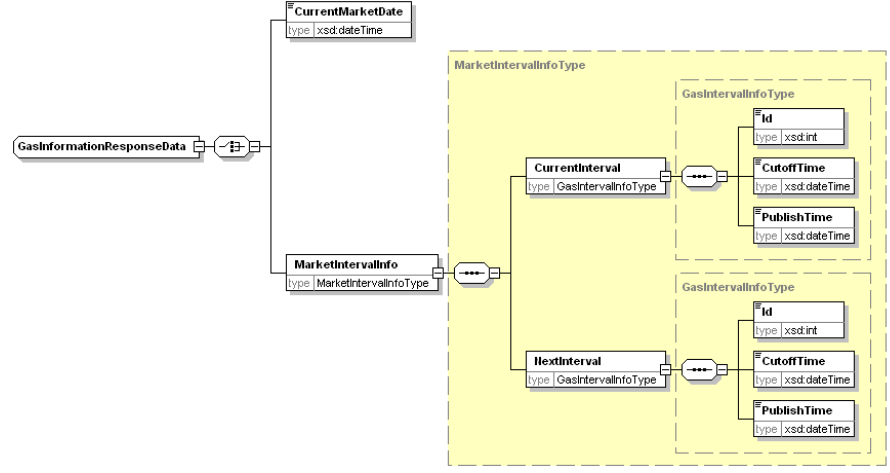
<b>Output Schema</b>	<pre> &lt;xsd:complexType name="GasInformationResponseData"&gt;   &lt;xsd:complexContent&gt;     &lt;xsd:extension base="WholesaleInformationResponseData"&gt;       &lt;xsd:choice&gt;         ...         &lt;xsd:element name="MarketIntervalInfo"           type="MarketIntervalInfoType"/&gt;         ...       &lt;/xsd:choice&gt;       &lt;xsd:attribute         name="version"         type="r30"         use="optional"         default="r30"/&gt;       &lt;xsd:attribute         name="contextType"         type="GasInformationTransactionType"         use="required"/&gt;     &lt;/xsd:extension&gt;   &lt;/xsd:complexContent&gt; &lt;/xsd:complexType&gt; </pre>
	

### 5.9.3.3 SOAP Faults

Fault Code	Fault Description
Global SOAP Faults	Refer to Global Fault Codes on page 61

### 5.9.3.4 Usage example

#### Request Sample

```
<ase:aseXML xmlns:ase="urn:aseXML:r31">
  <Header>
    <From>VENCorp WebExchanger Recipient</From>
    <To>VENCorp WebExchanger</To>
    <MessageID>7776454C-DE14-C88B-7255-DA6005F43272</MessageID>
    <MessageDate>2006-03-17T16:17:26.588+10:00</MessageDate>
    <TransactionGroup>MKTW</TransactionGroup>
    <Priority>Medium</Priority>
    <Market>VICGAS</Market>
  </Header>
  <Transactions>
    <Transaction transactionID="7776454C-DE14-C88B-7255-DA6005F43272"
      transactionDate="2006-03-17T16:17:26.588+10:00">
      <WholesaleInformationRequest version="r20">
        <InformationRequestData
          contextType="IntervalInfo"
          xsi:type="urn:GasInformationRequestData"
          xmlns:urn="urn:aseXML:r31"
          xmlns:xsi="http://www.w3.org/2001/XMLSchema-instance"/>
        </WholesaleInformationRequest>
      </Transaction>
    </Transactions>
  </ase:aseXML>
```

#### Response Sample 1

```
<ase:aseXML xmlns:ase="urn:aseXML:r31">
  <Header>
    <From>VENCorp WebExchanger</From>
    <To>VENCorp WebExchanger Recipient</To>
    <MessageID>8585A887-20F2-A673-031E-EE3B26B95772</MessageID>
    <MessageDate>2006-03-17T16:17:36.275+10:00</MessageDate>
    <TransactionGroup>MKTW</TransactionGroup>
    <Priority>Medium</Priority>
    <Market>VICGAS</Market>
  </Header>
  <Transactions>
    <Transaction transactionID="8585A887-20F2-A673-031E-EE3B26B95772"
      transactionDate="2007-08-17T05:30:00.000+10:00">
      <WholesaleInformationResponse version="r20">
        <InformationResponseData
          contextType="IntervalInfo"
          xsi:type="urn:GasInformationResponseData"
          xmlns:urn="urn:aseXML:r31"
          xmlns:xsi="http://www.w3.org/2001/XMLSchema-instance">
          <MarketIntervalInfo>
            <CurrentInterval>
              <Id>1</Id>
              <CutoffTime>2007-08-17T05:00:00.000+10:00</CutoffTime>
              <PublishTime>2007-08-17T06:00:00.000+10:00</PublishTime>
            </CurrentInterval>
            <NextInterval>
              <Id>2</Id>
              <CutoffTime>2007-08-17T09:00:00.000+10:00</CutoffTime>
              <PublishTime>2007-08-17T10:00:00.000+10:00</PublishTime>
            </NextInterval>
          </MarketIntervalInfo>
        </InformationResponseData>
      </WholesaleInformationResponse>
    </Transaction>
  </Transactions>
</ase:aseXML>
```

## Response Sample 2

```

<ase:aseXML xmlns:ase="urn:aseXML:r31">
  <Header>
    <From>VENCorp WebExchanger</From>
    <To>VENCorp WebExchanger Recipient</To>
    <MessageID>8585A887-20F2-A673-031E-EE3B26B95772</MessageID>
    <MessageDate>2006-03-17T16:17:36.275+10:00</MessageDate>
    <TransactionGroup>MKTW</TransactionGroup>
    <Priority>Medium</Priority>
    <Market>VICGAS</Market>
  </Header>
  <Transactions>
    <Transaction transactionID="8585A887-20F2-A673-031E-EE3B26B95772"
      transactionDate="2007-08-17T22:30:00.000+10:00">
      <WholesaleInformationResponse version="r20">
        <InformationResponseData
          contextType="IntervalInfo"
          xsi:type="urn:GasInformationResponseData"
          xmlns:urn="urn:aseXML:r31"
          xmlns:xsi="http://www.w3.org/2001/XMLSchema-instance">
          <MarketIntervalInfo>
            <CurrentInterval>
              <Id>5</Id>
              <CutoffTime>2007-08-17T21:00:00.000+10:00</CutoffTime>
              <PublishTime>2007-08-17T22:00:00.000+10:00</PublishTime>
            </CurrentInterval>
            <NextInterval>
              <Id>1</Id>
              <CutoffTime>2007-08-18T05:00:00.000+10:00</CutoffTime>
              <PublishTime>2007-08-18T06:00:00.000+10:00</PublishTime>
            </NextInterval>
          </MarketIntervalInfo>
        </InformationResponseData>
      </WholesaleInformationResponse>
    </Transaction>
  </Transactions>
</ase:aseXML>

```

## 6 Appendix A. Bids Service WSDL

Web Services Description Language (WSDL) file for WebExchanger bids web services.

```
<?xml version="1.0" encoding="UTF-8"?>
<wsdl:definitions targetNamespace="urn:aseXML:r31"
xmlns:apachesoap="http://xml.apache.org/xml-soap" xmlns:impl="urn:aseXML:r31"
xmlns:intf="urn:aseXML:r31" xmlns:wsdl="http://schemas.xmlsoap.org/wsdl/"
xmlns:wsoap="http://schemas.xmlsoap.org/wsdl/soap/"
xmlns:xsd="http://www.w3.org/2001/XMLSchema">
<!--WSDL created by Apache Axis version: 1.4
Built on Apr 22, 2006 (06:55:48 PDT)-->
<wsdl:types>
<schema elementFormDefault="qualified" targetNamespace="urn:aseXML:r31"
xmlns="http://www.w3.org/2001/XMLSchema">
<element name="submitBid">
<complexType>
<sequence>
<element name="in0" type="xsd:string"/>
</sequence>
</complexType>
</element>
<element name="submitBidResponse">
<complexType>
<sequence>
<element name="submitBidReturn" type="xsd:string"/>
</sequence>
</complexType>
</element>
<element name="getBidSetForCGD">
<complexType>
<sequence>
<element name="in0" type="xsd:string"/>
</sequence>
</complexType>
</element>
<element name="getBidSetForCGDResponse">
<complexType>
<sequence>
<element name="getBidSetForCGDReturn" type="xsd:string"/>
</sequence>
</complexType>
</element>
<element name="getBidSet">
<complexType>
<sequence>
<element name="in0" type="xsd:string"/>
</sequence>
</complexType>
</element>
<element name="getBidSetResponse">
<complexType>
<sequence>
<element name="getBidSetReturn" type="xsd:string"/>
</sequence>
</complexType>
</element>
<element name="getBid">
<complexType>
<sequence>
<element name="in0" type="xsd:string"/>
</sequence>
</complexType>
</element>
<element name="getBidResponse">
<complexType>
<sequence>
<element name="getBidReturn" type="xsd:string"/>
</sequence>
</complexType>
</element>
</wsdl:types>
</wsdl:definitions>
```

```

</complexType>
</element>
<element name="searchBids">
  <complexType>
    <sequence>
      <element name="in0" type="xsd:string"/>
    </sequence>
  </complexType>
</element>
<element name="searchBidsResponse">
  <complexType>
    <sequence>
      <element name="searchBidsReturn" type="xsd:string"/>
    </sequence>
  </complexType>
</element>
</schema>
</wsdl:types>

<wsdl:message name="searchBidsResponse">
  <wsdl:part element="impl:searchBidsResponse" name="parameters">
  </wsdl:part>
</wsdl:message>

<wsdl:message name="submitBidRequest">
  <wsdl:part element="impl:submitBid" name="parameters">
  </wsdl:part>
</wsdl:message>

<wsdl:message name="getBidSetForCGDResponse">
  <wsdl:part element="impl:getBidSetForCGDResponse" name="parameters">
  </wsdl:part>
</wsdl:message>

<wsdl:message name="getBidResponse">
  <wsdl:part element="impl:getBidResponse" name="parameters">
  </wsdl:part>
</wsdl:message>

<wsdl:message name="getBidSetForCGDRequest">
  <wsdl:part element="impl:getBidSetForCGD" name="parameters">
  </wsdl:part>
</wsdl:message>

<wsdl:message name="submitBidResponse">
  <wsdl:part element="impl:submitBidResponse" name="parameters">
  </wsdl:part>
</wsdl:message>

<wsdl:message name="getBidRequest">
  <wsdl:part element="impl:getBid" name="parameters">
  </wsdl:part>

```

```

</wsdl:message>
<wsdl:message name="getBidSetResponse">
  <wsdl:part element="impl:getBidSetResponse" name="parameters">
    </wsdl:part>
  </wsdl:message>
<wsdl:message name="getBidSetRequest">
  <wsdl:part element="impl:getBidSet" name="parameters">
    </wsdl:part>
  </wsdl:message>
<wsdl:message name="searchBidsRequest">
  <wsdl:part element="impl:searchBids" name="parameters">
    </wsdl:part>
  </wsdl:message>
<wsdl:portType name="BidServiceWS">
  <wsdl:operation name="submitBid">
    <wsdl:input message="impl:submitBidRequest" name="submitBidRequest">
      </wsdl:input>
    <wsdl:output message="impl:submitBidResponse" name="submitBidResponse">
      </wsdl:output>
    </wsdl:operation>
  <wsdl:operation name="getBidSetForCGD">
    <wsdl:input message="impl:getBidSetForCGDRequest" name="getBidSetForCGDRequest">
      </wsdl:input>
    <wsdl:output message="impl:getBidSetForCGDResponse"
name="getBidSetForCGDResponse">
      </wsdl:output>
    </wsdl:operation>
  <wsdl:operation name="getBidSet">
    <wsdl:input message="impl:getBidSetRequest" name="getBidSetRequest">
      </wsdl:input>
    <wsdl:output message="impl:getBidSetResponse" name="getBidSetResponse">
      </wsdl:output>
    </wsdl:operation>
  <wsdl:operation name="getBid">
    <wsdl:input message="impl:getBidRequest" name="getBidRequest">
      </wsdl:input>

```

```

    <wsdl:output message="impl:getBidResponse" name="getBidResponse">
  </wsdl:output>
</wsdl:operation>
<wsdl:operation name="searchBids">
  <wsdl:input message="impl:searchBidsRequest" name="searchBidsRequest">
  </wsdl:input>
  <wsdl:output message="impl:searchBidsResponse" name="searchBidsResponse">
  </wsdl:output>
</wsdl:operation>
</wsdl:portType>
<wsdl:binding name="BidServiceWSSoapBinding" type="impl:BidServiceWS">
  <wsdlsoap:binding style="document"
transport="http://schemas.xmlsoap.org/soap/http"/>
  <wsdl:operation name="submitBid">
    <wsdlsoap:operation soapAction=""/>
    <wsdl:input name="submitBidRequest">
      <wsdlsoap:body use="literal"/>
    </wsdl:input>
    <wsdl:output name="submitBidResponse">
      <wsdlsoap:body use="literal"/>
    </wsdl:output>
  </wsdl:operation>
  <wsdl:operation name="getBidSetForCGD">
    <wsdlsoap:operation soapAction=""/>
    <wsdl:input name="getBidSetForCGDRequest">
      <wsdlsoap:body use="literal"/>
    </wsdl:input>
    <wsdl:output name="getBidSetForCGDResponse">
      <wsdlsoap:body use="literal"/>
    </wsdl:output>
  </wsdl:operation>
  <wsdl:operation name="getBidSet">
    <wsdlsoap:operation soapAction=""/>
    <wsdl:input name="getBidSetRequest">
      <wsdlsoap:body use="literal"/>
    </wsdl:input>
    <wsdl:output name="getBidSetResponse">

```



```
        <wsdlsoap:body use="literal"/>
    </wsdl:output>
</wsdl:operation>
<wsdl:operation name="getBid">
    <wsdlsoap:operation soapAction=""/>
    <wsdl:input name="getBidRequest">
        <wsdlsoap:body use="literal"/>
    </wsdl:input>
    <wsdl:output name="getBidResponse">
        <wsdlsoap:body use="literal"/>
    </wsdl:output>
</wsdl:operation>
<wsdl:operation name="searchBids">
    <wsdlsoap:operation soapAction=""/>
    <wsdl:input name="searchBidsRequest">
        <wsdlsoap:body use="literal"/>
    </wsdl:input>
    <wsdl:output name="searchBidsResponse">
        <wsdlsoap:body use="literal"/>
    </wsdl:output>
</wsdl:operation>
</wsdl:binding>
<wsdl:service name="BidServiceWSService">
    <wsdl:port binding="impl:BidServiceWSSoapBinding" name="BidServiceWS">
        <wsdlsoap:address location="http://localhost:8181/webex-
ws/services/BidServiceWS"/>
    </wsdl:port>
</wsdl:service>
</wsdl:definitions>
```

## 7 Appendix B. Participants Demand Forecast Service WSDL

Web Services Description Language (WSDL) file for WebExchanger demand forecast web services.

```
<?xml version="1.0" encoding="UTF-8"?>
<wSDL:definitions targetNamespace="urn:aseXML:r31"
xmlns:apachesoap="http://xml.apache.org/xml-soap" xmlns:impl="urn:aseXML:r31"
xmlns:intf="urn:aseXML:r31" xmlns:wSDL="http://schemas.xmlsoap.org/wSDL/"
xmlns:wSDLsoap="http://schemas.xmlsoap.org/wSDL/soap/"
xmlns:xsd="http://www.w3.org/2001/XMLSchema">
<!--WSDL created by Apache Axis version: 1.4
Built on Apr 22, 2006 (06:55:48 PDT)-->
<wSDL:types>
  <schema elementFormDefault="qualified" targetNamespace="urn:aseXML:r31"
xmlns="http://www.w3.org/2001/XMLSchema">
    <element name="searchForecasts">
      <complexType>
        <sequence>
          <element name="in0" type="xsd:string"/>
        </sequence>
      </complexType>
    </element>
    <element name="searchForecastsResponse">
      <complexType>
        <sequence>
          <element name="searchForecastsReturn" type="xsd:string"/>
        </sequence>
      </complexType>
    </element>
    <element name="getValidationValues">
      <complexType>
        <sequence>
          <element name="in0" type="xsd:string"/>
        </sequence>
      </complexType>
    </element>
    <element name="getValidationValuesResponse">
      <complexType>
        <sequence>
          <element name="getValidationValuesReturn" type="xsd:string"/>
        </sequence>
      </complexType>
    </element>
    <element name="getForecast">
      <complexType>
        <sequence>
          <element name="in0" type="xsd:string"/>
        </sequence>
      </complexType>
    </element>
    <element name="getForecastResponse">
      <complexType>
        <sequence>
          <element name="getForecastReturn" type="xsd:string"/>
        </sequence>
      </complexType>
    </element>
    <element name="setValidationValues">
      <complexType>
        <sequence>
          <element name="in0" type="xsd:string"/>
        </sequence>
      </complexType>
    </element>
    <element name="setValidationValuesResponse">
      <complexType>
        <sequence>
```

```

    <element name="setValidationValuesReturn" type="xsd:string"/>
  </sequence>
</complexType>
</element>
<element name="submitForecast">
  <complexType>
    <sequence>
      <element name="in0" type="xsd:string"/>
    </sequence>
  </complexType>
</element>
<element name="submitForecastResponse">
  <complexType>
    <sequence>
      <element name="submitForecastReturn" type="xsd:string"/>
    </sequence>
  </complexType>
</element>
<element name="getForecastForCGD">
  <complexType>
    <sequence>
      <element name="in0" type="xsd:string"/>
    </sequence>
  </complexType>
</element>
<element name="getForecastForCGDResponse">
  <complexType>
    <sequence>
      <element name="getForecastForCGDReturn" type="xsd:string"/>
    </sequence>
  </complexType>
</element>
</schema>
</wsdl:types>

<wsdl:message name="getValidationValuesResponse">
  <wsdl:part element="impl:getValidationValuesResponse" name="parameters">
  </wsdl:part>
</wsdl:message>

<wsdl:message name="getForecastRequest">
  <wsdl:part element="impl:getForecast" name="parameters">
  </wsdl:part>
</wsdl:message>

<wsdl:message name="searchForecastsRequest">
  <wsdl:part element="impl:searchForecasts" name="parameters">
  </wsdl:part>
</wsdl:message>

<wsdl:message name="setValidationValuesResponse">
  <wsdl:part element="impl:setValidationValuesResponse" name="parameters">
  </wsdl:part>
</wsdl:message>

<wsdl:message name="getForecastForCGDResponse">
  <wsdl:part element="impl:getForecastForCGDResponse" name="parameters">
  </wsdl:part>

```

```
</wsdl:message>
<wsdl:message name="getForecastResponse">
  <wsdl:part element="impl:getForecastResponse" name="parameters">
  </wsdl:part>
</wsdl:message>
<wsdl:message name="getForecastForCGDRequest">
  <wsdl:part element="impl:getForecastForCGD" name="parameters">
  </wsdl:part>
</wsdl:message>
<wsdl:message name="submitForecastResponse">
  <wsdl:part element="impl:submitForecastResponse" name="parameters">
  </wsdl:part>
</wsdl:message>
<wsdl:message name="searchForecastsResponse">
  <wsdl:part element="impl:searchForecastsResponse" name="parameters">
  </wsdl:part>
</wsdl:message>
<wsdl:message name="getValidationValuesRequest">
  <wsdl:part element="impl:getValidationValues" name="parameters">
  </wsdl:part>
</wsdl:message>
<wsdl:message name="setValidationValuesRequest">
  <wsdl:part element="impl:setValidationValues" name="parameters">
  </wsdl:part>
</wsdl:message>
<wsdl:message name="submitForecastRequest">
  <wsdl:part element="impl:submitForecast" name="parameters">
  </wsdl:part>
</wsdl:message>
<wsdl:portType name="DemandForecastServiceWS">
  <wsdl:operation name="searchForecasts">
    <wsdl:input message="impl:searchForecastsRequest" name="searchForecastsRequest">
    </wsdl:input>
    <wsdl:output message="impl:searchForecastsResponse"
name="searchForecastsResponse">
    </wsdl:output>
```

```
</wsdl:operation>

<wsdl:operation name="getValidationValues">
    <wsdl:input message="impl:getValidationValuesRequest"
name="getValidationValuesRequest">
        </wsdl:input>
    <wsdl:output message="impl:getValidationValuesResponse"
name="getValidationValuesResponse">
        </wsdl:output>
    </wsdl:operation>
<wsdl:operation name="getForecast">
    <wsdl:input message="impl:getForecastRequest" name="getForecastRequest">
        </wsdl:input>
    <wsdl:output message="impl:getForecastResponse" name="getForecastResponse">
        </wsdl:output>
    </wsdl:operation>
<wsdl:operation name="setValidationValues">
    <wsdl:input message="impl:setValidationValuesRequest"
name="setValidationValuesRequest">
        </wsdl:input>
    <wsdl:output message="impl:setValidationValuesResponse"
name="setValidationValuesResponse">
        </wsdl:output>
    </wsdl:operation>
<wsdl:operation name="submitForecast">
    <wsdl:input message="impl:submitForecastRequest" name="submitForecastRequest">
        </wsdl:input>
    <wsdl:output message="impl:submitForecastResponse"
name="submitForecastResponse">
        </wsdl:output>
    </wsdl:operation>
<wsdl:operation name="getForecastForCGD">
    <wsdl:input message="impl:getForecastForCGDRequest"
name="getForecastForCGDRequest">
        </wsdl:input>
    <wsdl:output message="impl:getForecastForCGDResponse"
name="getForecastForCGDResponse">
        </wsdl:output>
    </wsdl:operation>
</wsdl:portType>
```

```
<wsdl:binding name="DemandForecastServiceWSSoapBinding"
type="impl:DemandForecastServiceWS">
  <wsdlsoap:binding style="document"
transport="http://schemas.xmlsoap.org/soap/http"/>
  <wsdl:operation name="searchForecasts">
    <wsdlsoap:operation soapAction=""/>
    <wsdl:input name="searchForecastsRequest">
      <wsdlsoap:body use="literal"/>
    </wsdl:input>
    <wsdl:output name="searchForecastsResponse">
      <wsdlsoap:body use="literal"/>
    </wsdl:output>
  </wsdl:operation>
  <wsdl:operation name="getValidationValues">
    <wsdlsoap:operation soapAction=""/>
    <wsdl:input name="getValidationValuesRequest">
      <wsdlsoap:body use="literal"/>
    </wsdl:input>
    <wsdl:output name="getValidationValuesResponse">
      <wsdlsoap:body use="literal"/>
    </wsdl:output>
  </wsdl:operation>
  <wsdl:operation name="getForecast">
    <wsdlsoap:operation soapAction=""/>
    <wsdl:input name="getForecastRequest">
      <wsdlsoap:body use="literal"/>
    </wsdl:input>
    <wsdl:output name="getForecastResponse">
      <wsdlsoap:body use="literal"/>
    </wsdl:output>
  </wsdl:operation>
  <wsdl:operation name="setValidationValues">
    <wsdlsoap:operation soapAction=""/>
    <wsdl:input name="setValidationValuesRequest">
      <wsdlsoap:body use="literal"/>
    </wsdl:input>
    <wsdl:output name="setValidationValuesResponse">
```

```

        <wsdlsoap:body use="literal"/>
    </wsdl:output>
</wsdl:operation>
<wsdl:operation name="submitForecast">
    <wsdlsoap:operation soapAction=""/>
    <wsdl:input name="submitForecastRequest">
        <wsdlsoap:body use="literal"/>
    </wsdl:input>
    <wsdl:output name="submitForecastResponse">
        <wsdlsoap:body use="literal"/>
    </wsdl:output>
</wsdl:operation>
<wsdl:operation name="getForecastForCGD">
    <wsdlsoap:operation soapAction=""/>
    <wsdl:input name="getForecastForCGDRequest">
        <wsdlsoap:body use="literal"/>
    </wsdl:input>
    <wsdl:output name="getForecastForCGDResponse">
        <wsdlsoap:body use="literal"/>
    </wsdl:output>
</wsdl:operation>
</wsdl:binding>
<wsdl:service name="DemandForecastServiceWSService">
    <wsdl:port binding="impl:DemandForecastServiceWSSoapBinding"
name="DemandForecastServiceWS">
        <wsdlsoap:address location="http://localhost:8181/webex-
ws/services/DemandForecastServiceWS"/>
    </wsdl:port>
</wsdl:service>
</wsdl:definitions>

```

## 8 Appendix C. Injection Hedge Nomination Service WSDL

Web Services Description Language (WSDL) file for WebExchanger injection hedge nomination web services.

```
<?xml version="1.0" encoding="UTF-8"?>
<wsdl:definitions targetNamespace="urn:aseXML:r31"
xmlns:apachesoap="http://xml.apache.org/xml-soap" xmlns:impl="urn:aseXML:r31"
xmlns:intf="urn:aseXML:r31" xmlns:wsdl="http://schemas.xmlsoap.org/wsdl/"
xmlns:wsoap="http://schemas.xmlsoap.org/wsdl/soap/"
xmlns:xsd="http://www.w3.org/2001/XMLSchema">
  <!--WSDL created by Apache Axis version: 1.4
  Built on Apr 22, 2006 (06:55:48 PDT)-->
  <wsdl:types>
    <schema elementFormDefault="qualified" targetNamespace="urn:aseXML:r31"
xmlns="http://www.w3.org/2001/XMLSchema">
      <element name="searchInjectionHedgeNominations">
        <complexType>
          <sequence>
            <element name="in0" type="xsd:string"/>
          </sequence>
        </complexType>
      </element>
      <element name="searchInjectionHedgeNominationsResponse">
        <complexType>
          <sequence>
            <element name="searchInjectionHedgeNominationsReturn" type="xsd:string"/>
          </sequence>
        </complexType>
      </element>
      <element name="submitInjectionHedgeNomination">
        <complexType>
          <sequence>
            <element name="in0" type="xsd:string"/>
          </sequence>
        </complexType>
      </element>
      <element name="submitInjectionHedgeNominationResponse">
        <complexType>
          <sequence>
            <element name="submitInjectionHedgeNominationReturn" type="xsd:string"/>
          </sequence>
        </complexType>
      </element>
      <element name="getInjectionHedgeNominationForCGD">
        <complexType>
          <sequence>
            <element name="in0" type="xsd:string"/>
          </sequence>
        </complexType>
      </element>
      <element name="getInjectionHedgeNominationForCGDResponse">
        <complexType>
          <sequence>
            <element name="getInjectionHedgeNominationForCGDReturn" type="xsd:string"/>
          </sequence>
        </complexType>
      </element>
      <element name="getInjectionHedgeNomination">
        <complexType>
          <sequence>
            <element name="in0" type="xsd:string"/>
          </sequence>
        </complexType>
      </element>
      <element name="getInjectionHedgeNominationResponse">
        <complexType>
          <sequence>
```



```

    <element name="getInjectionHedgeNominationReturn" type="xsd:string"/>
  </sequence>
</complexType>
</element>
</schema>
</wsdl:types>

<wsdl:message name="getInjectionHedgeNominationResponse">
  <wsdl:part element="impl:getInjectionHedgeNominationResponse" name="parameters">
  </wsdl:part>
</wsdl:message>

<wsdl:message name="getInjectionHedgeNominationForCGDRequest">
  <wsdl:part element="impl:getInjectionHedgeNominationForCGD" name="parameters">
  </wsdl:part>
</wsdl:message>

<wsdl:message name="submitInjectionHedgeNominationResponse">
  <wsdl:part element="impl:submitInjectionHedgeNominationResponse" name="parameters">
  </wsdl:part>
</wsdl:message>

<wsdl:message name="getInjectionHedgeNominationForCGDResponse">
  <wsdl:part element="impl:getInjectionHedgeNominationForCGDResponse"
name="parameters">
  </wsdl:part>
</wsdl:message>

<wsdl:message name="submitInjectionHedgeNominationRequest">
  <wsdl:part element="impl:submitInjectionHedgeNomination" name="parameters">
  </wsdl:part>
</wsdl:message>

<wsdl:message name="searchInjectionHedgeNominationsResponse">
  <wsdl:part element="impl:searchInjectionHedgeNominationsResponse"
name="parameters">
  </wsdl:part>
</wsdl:message>

<wsdl:message name="getInjectionHedgeNominationRequest">
  <wsdl:part element="impl:getInjectionHedgeNomination" name="parameters">
  </wsdl:part>
</wsdl:message>

<wsdl:message name="searchInjectionHedgeNominationsRequest">
  <wsdl:part element="impl:searchInjectionHedgeNominations" name="parameters">
  </wsdl:part>
</wsdl:message>

```

```

<wsdl:portType name="InjectionHedgeNominationServiceWS">
  <wsdl:operation name="searchInjectionHedgeNominations">
    <wsdl:input message="impl:searchInjectionHedgeNominationsRequest"
name="searchInjectionHedgeNominationsRequest">
      </wsdl:input>
    <wsdl:output message="impl:searchInjectionHedgeNominationsResponse"
name="searchInjectionHedgeNominationsResponse">
      </wsdl:output>
    </wsdl:operation>
  <wsdl:operation name="submitInjectionHedgeNomination">
    <wsdl:input message="impl:submitInjectionHedgeNominationRequest"
name="submitInjectionHedgeNominationRequest">
      </wsdl:input>
    <wsdl:output message="impl:submitInjectionHedgeNominationResponse"
name="submitInjectionHedgeNominationResponse">
      </wsdl:output>
    </wsdl:operation>
  <wsdl:operation name="getInjectionHedgeNominationForCGD">
    <wsdl:input message="impl:getInjectionHedgeNominationForCGDRequest"
name="getInjectionHedgeNominationForCGDRequest">
      </wsdl:input>
    <wsdl:output message="impl:getInjectionHedgeNominationForCGDResponse"
name="getInjectionHedgeNominationForCGDResponse">
      </wsdl:output>
    </wsdl:operation>
  <wsdl:operation name="getInjectionHedgeNomination">
    <wsdl:input message="impl:getInjectionHedgeNominationRequest"
name="getInjectionHedgeNominationRequest">
      </wsdl:input>
    <wsdl:output message="impl:getInjectionHedgeNominationResponse"
name="getInjectionHedgeNominationResponse">
      </wsdl:output>
    </wsdl:operation>
</wsdl:portType>

<wsdl:binding name="InjectionHedgeNominationServiceWSSoapBinding"
type="impl:InjectionHedgeNominationServiceWS">
  <wsdlsoap:binding style="document"
transport="http://schemas.xmlsoap.org/soap/http"/>
  <wsdl:operation name="searchInjectionHedgeNominations">
    <wsdlsoap:operation soapAction=""/>
    <wsdl:input name="searchInjectionHedgeNominationsRequest">

```

```

        <wsdlsoap:body use="literal"/>
    </wsdl:input>
    <wsdl:output name="searchInjectionHedgeNominationsResponse">
        <wsdlsoap:body use="literal"/>
    </wsdl:output>
</wsdl:operation>
<wsdl:operation name="submitInjectionHedgeNomination">
    <wsdlsoap:operation soapAction=""/>
    <wsdl:input name="submitInjectionHedgeNominationRequest">
        <wsdlsoap:body use="literal"/>
    </wsdl:input>
    <wsdl:output name="submitInjectionHedgeNominationResponse">
        <wsdlsoap:body use="literal"/>
    </wsdl:output>
</wsdl:operation>
<wsdl:operation name="getInjectionHedgeNominationForCGD">
    <wsdlsoap:operation soapAction=""/>
    <wsdl:input name="getInjectionHedgeNominationForCGDRequest">
        <wsdlsoap:body use="literal"/>
    </wsdl:input>
    <wsdl:output name="getInjectionHedgeNominationForCGDResponse">
        <wsdlsoap:body use="literal"/>
    </wsdl:output>
</wsdl:operation>
<wsdl:operation name="getInjectionHedgeNomination">
    <wsdlsoap:operation soapAction=""/>
    <wsdl:input name="getInjectionHedgeNominationRequest">
        <wsdlsoap:body use="literal"/>
    </wsdl:input>
    <wsdl:output name="getInjectionHedgeNominationResponse">
        <wsdlsoap:body use="literal"/>
    </wsdl:output>
</wsdl:operation>
</wsdl:binding>
<wsdl:service name="InjectionHedgeNominationServiceWSService">

```

```
<wsdl:port binding="impl:InjectionHedgeNominationServiceWSSoapBinding"
name="InjectionHedgeNominationServiceWS">
    <wsdlsoap:address location="http://localhost:8181/webex-
ws/services/InjectionHedgeNominationServiceWS"/>
</wsdl:port>
</wsdl:service>
</wsdl:definitions>
```

## 9 Appendix D. Agency Hedge Nomination Service WSDL

Web Services Description Language (WSDL) file for WebExchanger agency hedge nomination web services.

```
<?xml version="1.0" encoding="UTF-8"?>
<wsdl:definitions targetNamespace="urn:aseXML:r31"
xmlns:apachesoap="http://xml.apache.org/xml-soap" xmlns:impl="urn:aseXML:r31"
xmlns:intf="urn:aseXML:r31" xmlns:wsdl="http://schemas.xmlsoap.org/wsdl/"
xmlns:wsoap="http://schemas.xmlsoap.org/wsdl/soap/"
xmlns:xsd="http://www.w3.org/2001/XMLSchema">
<!--WSDL created by Apache Axis version: 1.4
Built on Apr 22, 2006 (06:55:48 PDT)-->
<wsdl:types>
<schema elementFormDefault="qualified" targetNamespace="urn:aseXML:r31"
xmlns="http://www.w3.org/2001/XMLSchema">
<element name="searchNominations">
<complexType>
<sequence>
<element name="in0" type="xsd:string"/>
</sequence>
</complexType>
</element>
<element name="searchNominationsResponse">
<complexType>
<sequence>
<element name="searchNominationsReturn" type="xsd:string"/>
</sequence>
</complexType>
</element>
<element name="searchConfirmations">
<complexType>
<sequence>
<element name="in0" type="xsd:string"/>
</sequence>
</complexType>
</element>
<element name="searchConfirmationsResponse">
<complexType>
<sequence>
<element name="searchConfirmationsReturn" type="xsd:string"/>
</sequence>
</complexType>
</element>
<element name="submitNominationWithdrawn">
<complexType>
<sequence>
<element name="in0" type="xsd:string"/>
</sequence>
</complexType>
</element>
<element name="submitNominationWithdrawnResponse">
<complexType>
<sequence>
<element name="submitNominationWithdrawnReturn" type="xsd:string"/>
</sequence>
</complexType>
</element>
<element name="submitWithdrawnNominationConfirmed">
<complexType>
<sequence>
<element name="in0" type="xsd:string"/>
</sequence>
</complexType>
</element>
<element name="submitWithdrawnNominationConfirmedResponse">
<complexType>
<sequence>
```

```

    <element name="submitWithdrawnNominationConfirmedReturn" type="xsd:string"/>
  </sequence>
</complexType>
</element>
<element name="getAgencyNominationHeader">
  <complexType>
    <sequence>
      <element name="in0" type="xsd:string"/>
    </sequence>
  </complexType>
</element>
<element name="getAgencyNominationHeaderResponse">
  <complexType>
    <sequence>
      <element name="getAgencyNominationHeaderReturn" type="xsd:string"/>
    </sequence>
  </complexType>
</element>
<element name="getAgencyConfirmationHeader">
  <complexType>
    <sequence>
      <element name="in0" type="xsd:string"/>
    </sequence>
  </complexType>
</element>
<element name="getAgencyConfirmationHeaderResponse">
  <complexType>
    <sequence>
      <element name="getAgencyConfirmationHeaderReturn" type="xsd:string"/>
    </sequence>
  </complexType>
</element>
<element name="getAgencyNominationDetail">
  <complexType>
    <sequence>
      <element name="in0" type="xsd:string"/>
    </sequence>
  </complexType>
</element>
<element name="getAgencyNominationDetailResponse">
  <complexType>
    <sequence>
      <element name="getAgencyNominationDetailReturn" type="xsd:string"/>
    </sequence>
  </complexType>
</element>
<element name="submitConfirmation">
  <complexType>
    <sequence>
      <element name="in0" type="xsd:string"/>
    </sequence>
  </complexType>
</element>
<element name="submitConfirmationResponse">
  <complexType>
    <sequence>
      <element name="submitConfirmationReturn" type="xsd:string"/>
    </sequence>
  </complexType>
</element>
<element name="submitNomination">
  <complexType>
    <sequence>
      <element name="in0" type="xsd:string"/>
    </sequence>
  </complexType>
</element>
<element name="submitNominationResponse">
  <complexType>
    <sequence>
      <element name="submitNominationReturn" type="xsd:string"/>
    </sequence>
  </complexType>
</element>

```

```
</complexType>
</element>
</schema>
</wsdl:types>

<wsdl:message name="getAgencyConfirmationHeaderRequest">
  <wsdl:part element="impl:getAgencyConfirmationHeader" name="parameters">
  </wsdl:part>
</wsdl:message>

<wsdl:message name="submitNominationWithdrawnResponse">
  <wsdl:part element="impl:submitNominationWithdrawnResponse" name="parameters">
  </wsdl:part>
</wsdl:message>

<wsdl:message name="searchNominationsResponse">
  <wsdl:part element="impl:searchNominationsResponse" name="parameters">
  </wsdl:part>
</wsdl:message>

<wsdl:message name="submitConfirmationRequest">
  <wsdl:part element="impl:submitConfirmation" name="parameters">
  </wsdl:part>
</wsdl:message>

<wsdl:message name="submitWithdrawnNominationConfirmedRequest">
  <wsdl:part element="impl:submitWithdrawnNominationConfirmed" name="parameters">
  </wsdl:part>
</wsdl:message>

<wsdl:message name="submitConfirmationResponse">
  <wsdl:part element="impl:submitConfirmationResponse" name="parameters">
  </wsdl:part>
</wsdl:message>

<wsdl:message name="submitNominationResponse">
  <wsdl:part element="impl:submitNominationResponse" name="parameters">
  </wsdl:part>
</wsdl:message>

<wsdl:message name="getAgencyNominationHeaderRequest">
  <wsdl:part element="impl:getAgencyNominationHeader" name="parameters">
  </wsdl:part>
</wsdl:message>

<wsdl:message name="searchConfirmationsRequest">
  <wsdl:part element="impl:searchConfirmations" name="parameters">
```

```
</wsdl:part>
</wsdl:message>
<wsdl:message name="getAgencyNominationHeaderResponse">
  <wsdl:part element="impl:getAgencyNominationHeaderResponse" name="parameters">
    </wsdl:part>
  </wsdl:message>
<wsdl:message name="submitNominationRequest">
  <wsdl:part element="impl:submitNomination" name="parameters">
    </wsdl:part>
  </wsdl:message>
<wsdl:message name="submitWithdrawnNominationConfirmedResponse">
  <wsdl:part element="impl:submitWithdrawnNominationConfirmedResponse"
name="parameters">
    </wsdl:part>
  </wsdl:message>
<wsdl:message name="searchNominationsRequest">
  <wsdl:part element="impl:searchNominations" name="parameters">
    </wsdl:part>
  </wsdl:message>
<wsdl:message name="submitNominationWithdrawnRequest">
  <wsdl:part element="impl:submitNominationWithdrawn" name="parameters">
    </wsdl:part>
  </wsdl:message>
<wsdl:message name="searchConfirmationsResponse">
  <wsdl:part element="impl:searchConfirmationsResponse" name="parameters">
    </wsdl:part>
  </wsdl:message>
<wsdl:message name="getAgencyNominationDetailRequest">
  <wsdl:part element="impl:getAgencyNominationDetail" name="parameters">
    </wsdl:part>
  </wsdl:message>
<wsdl:message name="getAgencyConfirmationHeaderResponse">
  <wsdl:part element="impl:getAgencyConfirmationHeaderResponse" name="parameters">
    </wsdl:part>
  </wsdl:message>
<wsdl:message name="getAgencyNominationDetailResponse">
```



```
<wsdl:part element="impl:getAgencyNominationDetailResponse" name="parameters">
</wsdl:part>
</wsdl:message>
<wsdl:portType name="AgencyNominationServiceWS">
  <wsdl:operation name="searchNominations">
    <wsdl:input message="impl:searchNominationsRequest"
name="searchNominationsRequest">
      </wsdl:input>
    <wsdl:output message="impl:searchNominationsResponse"
name="searchNominationsResponse">
      </wsdl:output>
    </wsdl:operation>
  <wsdl:operation name="searchConfirmations">
    <wsdl:input message="impl:searchConfirmationsRequest"
name="searchConfirmationsRequest">
      </wsdl:input>
    <wsdl:output message="impl:searchConfirmationsResponse"
name="searchConfirmationsResponse">
      </wsdl:output>
    </wsdl:operation>
  <wsdl:operation name="submitNominationWithdrawn">
    <wsdl:input message="impl:submitNominationWithdrawnRequest"
name="submitNominationWithdrawnRequest">
      </wsdl:input>
    <wsdl:output message="impl:submitNominationWithdrawnResponse"
name="submitNominationWithdrawnResponse">
      </wsdl:output>
    </wsdl:operation>
  <wsdl:operation name="submitWithdrawnNominationConfirmed">
    <wsdl:input message="impl:submitWithdrawnNominationConfirmedRequest"
name="submitWithdrawnNominationConfirmedRequest">
      </wsdl:input>
    <wsdl:output message="impl:submitWithdrawnNominationConfirmedResponse"
name="submitWithdrawnNominationConfirmedResponse">
      </wsdl:output>
    </wsdl:operation>
  <wsdl:operation name="getAgencyNominationHeader">
    <wsdl:input message="impl:getAgencyNominationHeaderRequest"
name="getAgencyNominationHeaderRequest">
      </wsdl:input>
```

```

        <wsdl:output message="impl:getAgencyNominationHeaderResponse"
name="getAgencyNominationHeaderResponse">
            </wsdl:output>
        </wsdl:operation>
        <wsdl:operation name="getAgencyConfirmationHeader">
            <wsdl:input message="impl:getAgencyConfirmationHeaderRequest"
name="getAgencyConfirmationHeaderRequest">
                </wsdl:input>
            <wsdl:output message="impl:getAgencyConfirmationHeaderResponse"
name="getAgencyConfirmationHeaderResponse">
                </wsdl:output>
            </wsdl:operation>
        <wsdl:operation name="getAgencyNominationDetail">
            <wsdl:input message="impl:getAgencyNominationDetailRequest"
name="getAgencyNominationDetailRequest">
                </wsdl:input>
            <wsdl:output message="impl:getAgencyNominationDetailResponse"
name="getAgencyNominationDetailResponse">
                </wsdl:output>
            </wsdl:operation>
        <wsdl:operation name="submitConfirmation">
            <wsdl:input message="impl:submitConfirmationRequest"
name="submitConfirmationRequest">
                </wsdl:input>
            <wsdl:output message="impl:submitConfirmationResponse"
name="submitConfirmationResponse">
                </wsdl:output>
            </wsdl:operation>
        <wsdl:operation name="submitNomination">
            <wsdl:input message="impl:submitNominationRequest"
name="submitNominationRequest">
                </wsdl:input>
            <wsdl:output message="impl:submitNominationResponse"
name="submitNominationResponse">
                </wsdl:output>
            </wsdl:operation>
    </wsdl:portType>
    <wsdl:binding name="AgencyNominationServiceWSSoapBinding"
type="impl:AgencyNominationServiceWS">
        <wsdlsoap:binding style="document"
transport="http://schemas.xmlsoap.org/soap/http"/>
        <wsdl:operation name="searchNominations">

```

```
<wsdlsoap:operation soapAction=""/>
<wsdl:input name="searchNominationsRequest">
  <wsdlsoap:body use="literal"/>
</wsdl:input>
<wsdl:output name="searchNominationsResponse">
  <wsdlsoap:body use="literal"/>
</wsdl:output>
</wsdl:operation>
<wsdl:operation name="searchConfirmations">
  <wsdlsoap:operation soapAction=""/>
  <wsdl:input name="searchConfirmationsRequest">
    <wsdlsoap:body use="literal"/>
  </wsdl:input>
  <wsdl:output name="searchConfirmationsResponse">
    <wsdlsoap:body use="literal"/>
  </wsdl:output>
</wsdl:operation>
<wsdl:operation name="submitNominationWithdrawn">
  <wsdlsoap:operation soapAction=""/>
  <wsdl:input name="submitNominationWithdrawnRequest">
    <wsdlsoap:body use="literal"/>
  </wsdl:input>
  <wsdl:output name="submitNominationWithdrawnResponse">
    <wsdlsoap:body use="literal"/>
  </wsdl:output>
</wsdl:operation>
<wsdl:operation name="submitWithdrawnNominationConfirmed">
  <wsdlsoap:operation soapAction=""/>
  <wsdl:input name="submitWithdrawnNominationConfirmedRequest">
    <wsdlsoap:body use="literal"/>
  </wsdl:input>
  <wsdl:output name="submitWithdrawnNominationConfirmedResponse">
    <wsdlsoap:body use="literal"/>
  </wsdl:output>
</wsdl:operation>
<wsdl:operation name="getAgencyNominationHeader">
```

```
<wsdlsoap:operation soapAction=""/>
<wsdl:input name="getAgencyNominationHeaderRequest">
  <wsdlsoap:body use="literal"/>
</wsdl:input>
<wsdl:output name="getAgencyNominationHeaderResponse">
  <wsdlsoap:body use="literal"/>
</wsdl:output>
</wsdl:operation>
<wsdl:operation name="getAgencyConfirmationHeader">
  <wsdlsoap:operation soapAction=""/>
  <wsdl:input name="getAgencyConfirmationHeaderRequest">
    <wsdlsoap:body use="literal"/>
  </wsdl:input>
  <wsdl:output name="getAgencyConfirmationHeaderResponse">
    <wsdlsoap:body use="literal"/>
  </wsdl:output>
</wsdl:operation>
<wsdl:operation name="getAgencyNominationDetail">
  <wsdlsoap:operation soapAction=""/>
  <wsdl:input name="getAgencyNominationDetailRequest">
    <wsdlsoap:body use="literal"/>
  </wsdl:input>
  <wsdl:output name="getAgencyNominationDetailResponse">
    <wsdlsoap:body use="literal"/>
  </wsdl:output>
</wsdl:operation>
<wsdl:operation name="submitConfirmation">
  <wsdlsoap:operation soapAction=""/>
  <wsdl:input name="submitConfirmationRequest">
    <wsdlsoap:body use="literal"/>
  </wsdl:input>
  <wsdl:output name="submitConfirmationResponse">
    <wsdlsoap:body use="literal"/>
  </wsdl:output>
</wsdl:operation>
<wsdl:operation name="submitNomination">
```

```
<wsdlsoap:operation soapAction=""/>
<wsdl:input name="submitNominationRequest">
  <wsdlsoap:body use="literal"/>
</wsdl:input>
<wsdl:output name="submitNominationResponse">
  <wsdlsoap:body use="literal"/>
</wsdl:output>
</wsdl:operation>
</wsdl:binding>
<wsdl:service name="AgencyNominationServiceWSService">
  <wsdl:port binding="impl:AgencyNominationServiceWSSoapBinding"
name="AgencyNominationServiceWS">
    <wsdlsoap:address location="http://localhost:8181/webex-
ws/services/AgencyNominationServiceWS"/>
  </wsdl:port>
</wsdl:service>
</wsdl:definitions>
```

## 10 Appendix D. AMDQ Nomination Service WSDL

Web Services Description Language (WSDL) file for WebExchanger AMDQ nomination web services.

```
<?xml version="1.0" encoding="UTF-8"?>
<wSDL:definitions targetNamespace="urn:aseXML:r31"
  xmlns:apachesoap="http://xml.apache.org/xml-soap" xmlns:impl="urn:aseXML:r31"
  xmlns:intf="urn:aseXML:r31" xmlns:wSDL="http://schemas.xmlsoap.org/wSDL/"
  xmlns:wSDLsoap="http://schemas.xmlsoap.org/wSDL/soap/"
  xmlns:xsd="http://www.w3.org/2001/XMLSchema">
<!--WSDL created by Apache Axis version: 1.4
Built on Apr 22, 2006 (06:55:48 PDT)-->
<wSDL:types>
<schema elementFormDefault="qualified" targetNamespace="urn:aseXML:r31"
  xmlns="http://www.w3.org/2001/XMLSchema">
  <element name="getAmdqNomination">
    <complexType>
      <sequence>
        <element name="in0" type="xsd:string"/>
      </sequence>
    </complexType>
  </element>
  <element name="getAmdqNominationResponse">
    <complexType>
      <sequence>
        <element name="getAmdqNominationReturn" type="xsd:string"/>
      </sequence>
    </complexType>
  </element>
  <element name="searchAmdqNominations">
    <complexType>
      <sequence>
        <element name="in0" type="xsd:string"/>
      </sequence>
    </complexType>
  </element>
  <element name="searchAmdqNominationsResponse">
    <complexType>
      <sequence>
        <element name="searchAmdqNominationsReturn" type="xsd:string"/>
      </sequence>
    </complexType>
  </element>
  <element name="submitAmdqNomination">
    <complexType>
      <sequence>
        <element name="in0" type="xsd:string"/>
      </sequence>
    </complexType>
  </element>
  <element name="submitAmdqNominationResponse">
    <complexType>
      <sequence>
        <element name="submitAmdqNominationReturn" type="xsd:string"/>
      </sequence>
    </complexType>
  </element>
  <element name="getAmdqNominationForCGD">
    <complexType>
      <sequence>
        <element name="in0" type="xsd:string"/>
      </sequence>
    </complexType>
  </element>
  <element name="getAmdqNominationForCGDResponse">
    <complexType>
      <sequence>
        <element name="getAmdqNominationForCGDReturn" type="xsd:string"/>
      </sequence>
    </complexType>
  </element>
</schema>
</wSDL:types>
</wSDL:definitions>
```

```
</complexType>
</element>
</schema>
</wsdl:types>

<wsdl:message name="submitAmdqNominationRequest">
  <wsdl:part element="impl:submitAmdqNomination" name="parameters">
    </wsdl:part>
  </wsdl:message>

<wsdl:message name="getAmdqNominationRequest">
  <wsdl:part element="impl:getAmdqNomination" name="parameters">
    </wsdl:part>
  </wsdl:message>

<wsdl:message name="getAmdqNominationForCGDRequest">
  <wsdl:part element="impl:getAmdqNominationForCGD" name="parameters">
    </wsdl:part>
  </wsdl:message>

<wsdl:message name="submitAmdqNominationResponse">
  <wsdl:part element="impl:submitAmdqNominationResponse" name="parameters">
    </wsdl:part>
  </wsdl:message>

<wsdl:message name="getAmdqNominationForCGDResponse">
  <wsdl:part element="impl:getAmdqNominationForCGDResponse" name="parameters">
    </wsdl:part>
  </wsdl:message>

<wsdl:message name="searchAmdqNominationsRequest">
  <wsdl:part element="impl:searchAmdqNominations" name="parameters">
    </wsdl:part>
  </wsdl:message>

<wsdl:message name="getAmdqNominationResponse">
  <wsdl:part element="impl:getAmdqNominationResponse" name="parameters">
    </wsdl:part>
  </wsdl:message>

<wsdl:message name="searchAmdqNominationsResponse">
  <wsdl:part element="impl:searchAmdqNominationsResponse" name="parameters">
    </wsdl:part>
  </wsdl:message>

<wsdl:portType name="AMDQServiceWS">
  <wsdl:operation name="getAmdqNomination">
```

```

        <wsdl:input message="impl:getAmdqNominationRequest"
name="getAmdqNominationRequest">

        </wsdl:input>

        <wsdl:output message="impl:getAmdqNominationResponse"
name="getAmdqNominationResponse">

        </wsdl:output>

    </wsdl:operation>

    <wsdl:operation name="searchAmdqNominations">

        <wsdl:input message="impl:searchAmdqNominationsRequest"
name="searchAmdqNominationsRequest">

        </wsdl:input>

        <wsdl:output message="impl:searchAmdqNominationsResponse"
name="searchAmdqNominationsResponse">

        </wsdl:output>

    </wsdl:operation>

    <wsdl:operation name="submitAmdqNomination">

        <wsdl:input message="impl:submitAmdqNominationRequest"
name="submitAmdqNominationRequest">

        </wsdl:input>

        <wsdl:output message="impl:submitAmdqNominationResponse"
name="submitAmdqNominationResponse">

        </wsdl:output>

    </wsdl:operation>

    <wsdl:operation name="getAmdqNominationForCGD">

        <wsdl:input message="impl:getAmdqNominationForCGDRequest"
name="getAmdqNominationForCGDRequest">

        </wsdl:input>

        <wsdl:output message="impl:getAmdqNominationForCGDResponse"
name="getAmdqNominationForCGDResponse">

        </wsdl:output>

    </wsdl:operation>

</wsdl:portType>

<wsdl:binding name="AMDQServiceWSSoapBinding" type="impl:AMDQServiceWS">

    <wsdlsoap:binding style="document"
transport="http://schemas.xmlsoap.org/soap/http"/>

    <wsdl:operation name="getAmdqNomination">

        <wsdlsoap:operation soapAction=""/>

        <wsdl:input name="getAmdqNominationRequest">

            <wsdlsoap:body use="literal"/>

        </wsdl:input>

```



```

    <wsdl:output name="getAmdqNominationResponse">
      <wsdlsoap:body use="literal"/>
    </wsdl:output>
  </wsdl:operation>
<wsdl:operation name="searchAmdqNominations">
  <wsdlsoap:operation soapAction=""/>
  <wsdl:input name="searchAmdqNominationsRequest">
    <wsdlsoap:body use="literal"/>
  </wsdl:input>
  <wsdl:output name="searchAmdqNominationsResponse">
    <wsdlsoap:body use="literal"/>
  </wsdl:output>
</wsdl:operation>
<wsdl:operation name="submitAmdqNomination">
  <wsdlsoap:operation soapAction=""/>
  <wsdl:input name="submitAmdqNominationRequest">
    <wsdlsoap:body use="literal"/>
  </wsdl:input>
  <wsdl:output name="submitAmdqNominationResponse">
    <wsdlsoap:body use="literal"/>
  </wsdl:output>
</wsdl:operation>
<wsdl:operation name="getAmdqNominationForCGD">
  <wsdlsoap:operation soapAction=""/>
  <wsdl:input name="getAmdqNominationForCGDRequest">
    <wsdlsoap:body use="literal"/>
  </wsdl:input>
  <wsdl:output name="getAmdqNominationForCGDResponse">
    <wsdlsoap:body use="literal"/>
  </wsdl:output>
</wsdl:operation>
</wsdl:binding>
<wsdl:service name="AMDQServiceWSService">
  <wsdl:port binding="impl:AMDQServiceWSSoapBinding" name="AMDQServiceWS">
    <wsdlsoap:address location="http://localhost:8181/webex-
ws/services/AMDQServiceWS"/>
  </wsdl:port>

```

```
</wsdl:service>  
</wsdl:definitions>
```

## 11 Appendix E. System Service WSDL

Web Services Description Language (WSDL) file for WebExchanger system web services.

```
<?xml version="1.0" encoding="UTF-8"?>
<wsdl:definitions targetNamespace="urn:aseXML:r31"
xmlns:apachesoap="http://xml.apache.org/xml-soap" xmlns:impl="urn:aseXML:r31"
xmlns:intf="urn:aseXML:r31" xmlns:wSDL="http://schemas.xmlsoap.org/wsdl/"
xmlns:wSDLsoap="http://schemas.xmlsoap.org/wsdl/soap/"
xmlns:xsd="http://www.w3.org/2001/XMLSchema">
<!--WSDL created by Apache Axis version: 1.4
Built on Apr 22, 2006 (06:55:48 PDT)-->
  <wsdl:types>
    <schema elementFormDefault="qualified" targetNamespace="urn:aseXML:r31"
xmlns="http://www.w3.org/2001/XMLSchema">
      <element name="getCurrentGasDate">
        <complexType>
          <sequence>
            <element name="in0" type="xsd:string"/>
          </sequence>
        </complexType>
      </element>
      <element name="getCurrentGasDateResponse">
        <complexType>
          <sequence>
            <element name="getCurrentGasDateReturn" type="xsd:string"/>
          </sequence>
        </complexType>
      </element>
      <element name="getIntervalInfo">
        <complexType>
          <sequence>
            <element name="in0" type="xsd:string"/>
          </sequence>
        </complexType>
      </element>
      <element name="getIntervalInfoResponse">
        <complexType>
          <sequence>
            <element name="getIntervalInfoReturn" type="xsd:string"/>
          </sequence>
        </complexType>
      </element>
    </schema>
  </wsdl:types>

  <wsdl:message name="getIntervalInfoRequest">
    <wsdl:part element="impl:getIntervalInfo" name="parameters">
    </wsdl:part>
  </wsdl:message>

  <wsdl:message name="getCurrentGasDateResponse">
    <wsdl:part element="impl:getCurrentGasDateResponse" name="parameters">
    </wsdl:part>
  </wsdl:message>

  <wsdl:message name="getCurrentGasDateRequest">
    <wsdl:part element="impl:getCurrentGasDate" name="parameters">
    </wsdl:part>
  </wsdl:message>
```

```

<wsdl:message name="getIntervalInfoResponse">
  <wsdl:part element="impl:getIntervalInfoResponse" name="parameters">
  </wsdl:part>
</wsdl:message>

<wsdl:portType name="SystemServiceWS">
  <wsdl:operation name="getCurrentGasDate">
    <wsdl:input message="impl:getCurrentGasDateRequest"
name="getCurrentGasDateRequest">
    </wsdl:input>
    <wsdl:output message="impl:getCurrentGasDateResponse"
name="getCurrentGasDateResponse">
    </wsdl:output>
  </wsdl:operation>
  <wsdl:operation name="getIntervalInfo">
    <wsdl:input message="impl:getIntervalInfoRequest" name="getIntervalInfoRequest">
    </wsdl:input>
    <wsdl:output message="impl:getIntervalInfoResponse"
name="getIntervalInfoResponse">
    </wsdl:output>
  </wsdl:operation>
</wsdl:portType>

<wsdl:binding name="SystemServiceWSSoapBinding" type="impl:SystemServiceWS">
  <wsdlsoap:binding style="document"
transport="http://schemas.xmlsoap.org/soap/http"/>
  <wsdl:operation name="getCurrentGasDate">
    <wsdlsoap:operation soapAction=""/>
    <wsdl:input name="getCurrentGasDateRequest">
      <wsdlsoap:body use="literal"/>
    </wsdl:input>
    <wsdl:output name="getCurrentGasDateResponse">
      <wsdlsoap:body use="literal"/>
    </wsdl:output>
  </wsdl:operation>
  <wsdl:operation name="getIntervalInfo">
    <wsdlsoap:operation soapAction=""/>
    <wsdl:input name="getIntervalInfoRequest">
      <wsdlsoap:body use="literal"/>
    </wsdl:input>
  </wsdl:operation>

```

```
<wsdl:output name="getIntervalInfoResponse">
  <wsdlsoap:body use="literal"/>
</wsdl:output>
</wsdl:operation>
</wsdl:binding>
<wsdl:service name="SystemServiceWSService">
  <wsdl:port binding="impl:SystemServiceWSSoapBinding" name="SystemServiceWS">
    <wsdlsoap:address location="http://localhost:8181/webex-
ws/services/SystemServiceWS"/>
  </wsdl:port>
</wsdl:service>
</wsdl:definitions>
```