



Style Definition: Heading 4: Space Before: 30 pt

Style Definition: Heading 5: Font: 11 pt, Indent: Left: 0 cm, First line: 0 cm, Outline numbered + Level: 5 + Aligned at: 0 cm + Indent at: 2 cm

Style Definition: Body Text: Space Before: 12 pt

Style Definition: Caption: Space Before: 18 pt

Style Definition: Body Table Number: Font: Not Bold, Indent: Left: 0.2 cm, Hanging: 0.4 cm, Numbered + Level: 1 + Numbering Style: 1, 2, 3, ... + Start at: 1 + Alignment: Left + Aligned at: 0.2 cm + Indent at: 1.38 cm

Style Definition: Lead In

MDM File Format and Load Process

5.085.14 Final

June 2020

Specifies the Meter Data Management (MDM) Format used by MDPs for the provision of Metering Data to AEMO

Important Notice

Purpose

This MDM File Format and Load Process (guide), prepared by the Australian Energy Market Operator (AEMO), provides guidance for MDPs to upload Meter Data under the National Electricity Rules (NER).

Formatted: Level 4

No Reliance Or Warranty

This document does not constitute legal or business advice, and should not be relied on as a substitute for obtaining detailed advice about the National Gas or Electricity Law, the Rules or any other applicable laws, procedures or policies. While AEMO has made every effort to ensure the quality of the information in this guide, neither AEMO nor any of its employees, agents, and consultants make any representation or warranty as to the accuracy, reliability, completeness, currency or suitability for particular purposes of that information.

Formatted: Level 4

Limitation Of Liability

To the maximum extent permitted by law, AEMO and its advisers, consultants and other contributors to this guide (or their respective associated companies, businesses, partners, directors, officers or employees) are not liable (whether by reason of negligence or otherwise) for any errors, omissions, defects or misrepresentations in this document, or for any loss or damage suffered by persons who use or rely on the information in it.

Formatted: Level 4

Distribution

Available to the public.

Formatted: Level 4

Trademark Notices

None.

Formatted: Level 4

Document Identification

Business custodian: Manager, Metering

IT custodian: Manager, Retail Systems

Prepared by: AEMO

Last update: Thursday, 25 June 2020 9:50 AM

Formatted: Level 4

Version History

[V5.08 Small changes to wording for accuracy in chapters 5 and 7. Fixed examples in Appendix 1. Changed the MD MF CSVIntervalData-period field format to number\(19,4\).](#)

[V5.14 Provides more clarity about how to FTP MTRD and MDMT meter data notifications to your Participant File Folders and which APIs to use for MDMT and MTRD delivery.](#)

Formatted: Level 4

Documents made obsolete

The release of this document changes only the version of MDM File Format and Load Process.

Formatted: Level 4

© 2020 Australian Energy Market Operator Limited.

The material in this publication may be used in accordance with the [copyright permissions on AEMO's website](#).

Feedback

Your feedback is important and helps us improve our services and products. To suggest improvements, please contact AEMO's Support Hub.

© 2020 Australian Energy Market Operator Limited.

The material in this publication may be used in accordance with the [copyright permissions on AEMO's website](#).

Contents

Error! Hyperlink reference not valid.	
Purpose.....	1
Error! Hyperlink reference not valid.	
What's in this guide	1
Error! Hyperlink reference not valid.	
How to use this guide	3
Error! Hyperlink reference not valid.	
National Electricity Rules	5
Error! Hyperlink reference not valid.	
Assumed knowledge	5
Error! Hyperlink reference not valid.	
Chapter 3 — About Metering Data Management	7
Error! Hyperlink reference not valid.	
Who can use	7
Error! Hyperlink reference not valid.	
Chapter 4 — Meter Data Messaging Exchange.....	8
Error! Hyperlink reference not valid.	
MDMT validation response.....	11
Error! Hyperlink reference not valid.	
MTRD message exchange.....	13
Error! Hyperlink reference not valid.	
MTRD events error code.....	19
Error! Hyperlink reference not valid.	
CSV Data Types	20
Error! Hyperlink reference not valid.	
Chapter 7 — File Format and Load.....	29
Error! Hyperlink reference not valid.	
Example file name	30
Error! Hyperlink reference not valid.	
File format by csv data type	31
Error! Hyperlink reference not valid.	

Chapter 8—Validation	42
Error! Hyperlink reference not valid.	
MTRD validations.....	46
Error! Hyperlink reference not valid.	
Validation failure error codes (MDM).....	51
Error! Hyperlink reference not valid.	
Chapter 10—Needing Help	53
Error! Hyperlink reference not valid.	
Chapter 11—References	54
Error! Hyperlink reference not valid.	
AEMO's website.....	54
Error! Hyperlink reference not valid.	
Example 1—One existing metering data record loads into MDM.....	56
Error! Hyperlink reference not valid.	
Example 3—Three existing metering data records loaded into MDM 2.....	59
Error! Hyperlink reference not valid.	
Example 5—One existing metering data record loaded into MDM 1.....	61
Error! Hyperlink reference not valid.	
Example 7—One existing metering data record loaded into MDM now spanning a period of inactive Data Stream.....	64
Error! Hyperlink reference not valid.	
Example 9—Data load in the first period of active Data Stream where existing metering data record loaded into MDM for second period of active Datastream.....	67
Error! Hyperlink reference not valid.	
Example 11—No existing metering data records loaded into MDM.....	69
Error! Hyperlink reference not valid.	
Chapter 1 Introduction	1
Purpose.....	1
Audience.....	1
What's in this guide.....	1
Related Resources.....	2
How to use this guide.....	3
Chapter 2 Need to Know	5
National Electricity Rules.....	5
Related procedures.....	5
Assumed knowledge.....	5

User rights access	5
Set participant	6
Chapter 3 About Metering Data Management	7
What is Metering Data Management	7
Who can use	7
How do you use	7
Chapter 4 Meter Data Messaging Exchange	8
MDMT messaging exchange	8
MDMT validation response	11
MDMT event error codes	13
MTRD message exchange	13
MTRD Transaction Acknowledgement Validation Response	16
MTRD events error code	19
Chapter 5 Meter Data Management Format (MDMF)	20
CSV Data Types	20
Chapter 6 Meter Data File Format (MDFF)	28
FTP file	29
Example file name	30
API common header parameters	30
File format by csv data type	31
Chapter 7 File Load	31
Transition information	32
Rules for uploading metering data	32
File size	32
aseXML message format	33
Header information	37
Transaction information	38
Transaction types	39
Participant file folder delivery	40
Chapter 8 Validation	42
MDMT validations	42
MTRD validations	46
MSATS Error Codes (MDM)	50
Validation failure error codes (MDM)	51

Chapter 9 Rules Terms.....	52
Chapter 10 Needing Help.....	53
Support hub.....	53
Chapter 11 References.....	54
Rules and law.....	54
AEMO's website.....	54
Appendix 1 Consumption Meter Data Record date relationship examples	56
Example 1 - One existing metering data record loads into MDM	56
Example 2 - Three existing metering data records loaded into MDM 1	57
Example 3 - Three existing metering data records loaded into MDM 2	59
Example 4 - Overlapping Meter Readings in a transaction	60
Example 5 - One existing metering data record loaded into MDM 1	61
Example 6 - One existing metering data record loaded into MDM 2	62
Example 7 - One existing metering data record loaded into MDM now spanning a period of inactive Data Stream.....	64
Example 8 - One existing metering data record loaded into MDM now spanning a period of inactive Data Stream.....	66
Example 9 - Data load in the first period of active Data Stream where existing metering data record loaded into MDM for second period of active Datastream.....	67
Example 10 - Data load in the first period of active Data Stream where existing metering data record loaded into MDM.....	68
Example 11 - No existing metering data records loaded into MDM.....	69
Example 12 - Existing metering data records loaded into MDM	71

Chapter 1 Introduction

Purpose

This guide specifies:

- The Meter Data Management Format (MDMF) and Metering Data File Format (MDFF) for Meter Data Providers (MDPs), providing Metering Data to AEMO.
- The creation and submission of the **MDMT** or **MTRD Meter Data Notification** transaction types.
- The process for uploading MDMF and MDFF files and the validations occurring during a file submission.

Audience

AEMO provides this information as a service targeting business analysts and IT staff in participant organisations.

1. The primary audience is Meter Data Providers (MDPs).
2. A secondary audience is Participant Administrators providing access to upload Metering Data for their Participant Users.

What's in this guide

Chapter 2 Need to Know provides information about the rules, procedures, assumed knowledge and user rights access for the MDM File Format and Load Process.

~~Chapter 3~~ Chapter 3 About Metering Data Management provides an overview of Metering Data Management, who can use it and how to use it.

Chapter 4 Meter Data Messaging Exchange explains the messaging exchange between an MDP and AEMO for submitting Meter Data Notifications.

Chapter 5 Meter Data Management Format (MDMF) explains the Meter Data Management Format.

Chapter 6 Meter Data File Format (MDFF) explains the Meter Data File Format.

~~Chapter 70 File Format and Load~~[File Load](#) explains the ~~file format and~~ loading of ~~metering data~~[Metering Data](#) to AEMO.

Chapter 8 Validation explains the MDMT and MTRD validation criteria and error codes for metering and non-Metering Data.

Chapter 9 Rules Terms provides a list of National Electricity Rules (NER) terms used throughout this guide.

Chapter 10 Needing Help provides information about contacting AEMO's Support Hub.

Chapter 11 References provides a list of references mentioned in this guide.

Appendix 1 Consumption Meter Data Record date relationship examples explains scenarios for Consumption Meter Data Record date relationships.

Related Resources

The following resources relate to the MDM File Format and Load Process. You need to read them along with this guide.

aseXML Schema: ~~https://www.aemo.com.au/Electricity/IT-Systems/aseXML_standards/aseXML-Schemas~~https://www.aemo.com.au/Electricity/IT-Systems/aseXML_standards/aseXML-Schemas

aseXML Guidelines: ~~https://www.aemo.com.au/Electricity/IT-Systems/aseXML_standards/aseXML-Guidelines~~https://www.aemo.com.au/Electricity/IT-Systems/aseXML_standards/aseXML-Guidelines

B2B Mapping to aseXML: ~~<https://aemo.com.au/Electricity/National-Electricity-Market-NEM/Retail-and-metering/Business-to-business-procedures>~~<https://aemo.com.au/Electricity/National-Electricity-Market-NEM/Retail-and-metering/Business-to-business-procedures>

B2B Procedure: Meter Data Process: Details the **Meter Data Notification (MDN)** process. ~~<https://aemo.com.au/Electricity/National-Electricity-Market-NEM/Retail-and-metering/Business-to-business-procedures>~~<https://aemo.com.au/Electricity/National-Electricity-Market-NEM/Retail-and-metering/Business-to-business-procedures>

MDFF Specification NEM12 NEM13: ~~<https://www.aemo.com.au/Electricity/National-Electricity-Market-NEM/Retail-and-metering/Metering-procedures-guidelines-and-processes>~~

MDM Procedures: <https://aemo.com.au/Electricity/National-Electricity-Market-NEM/Retail-and-metering/Market-Settlement-and-Transfer-Solutions>
<https://aemo.com.au/Electricity/National-Electricity-Market-NEM/Retail-and-metering/Market-Settlement-and-Transfer-Solutions>

Metrology Procedures: <https://aemo.com.au/Electricity/National-Electricity-Market-NEM/Retail-and-metering/Metrology-Procedures-and-Unmetered-Loads>
<https://aemo.com.au/Electricity/National-Electricity-Market-NEM/Retail-and-metering/Metrology-Procedures-and-Unmetered-Loads>

MSATS 46.96 Release Schedule and Technical Specification - 5MS - Meter Data:
Describes the technical changes and timelines for MDPs to transition their systems for the 5MS B2M Meter Data release. <https://aemo.com.au/Electricity/IT-Systems/IT-change>
<https://aemo.com.au/Electricity/IT-Systems/IT-change>

National Metering Identifier Procedure: sets out the structure for NMIs used in the NEM, details Data Streams for each category of metering installation, and addresses the matters contemplated in clauses 7.8.2(d)(2), and 7.8.2(ea) (eb) & (ec) of the NER. <https://aemo.com.au/Electricity/National-Electricity-Market-NEM/Retail-and-metering/Metering-procedures-guidelines-and-processes>
<https://aemo.com.au/Electricity/National-Electricity-Market-NEM/Retail-and-metering/Metering-procedures-guidelines-and-processes>

How to use this guide

Read this guide along with the related resources on page 2.

- This document is written in plain language for easy reading. Where there is a discrepancy between the Rules and information or a term in this document, the Rules take precedence.
- The references listed throughout this guide are primary resources and take precedence over this guide.
- Where there is a discrepancy between the Rules and information or a term in this document, the Rules take precedence.
- Where there is a discrepancy between the Procedures and information or a term in this document, the Procedures take precedence.
- **Text in this format** is a hyperlink to related information.

- **Text in this format** indicates a reference to a document. Unless otherwise stated, you can find resources mentioned in this guide on [AEMO's website](#)~~AEMO's website~~.
- **Text in this format** is an action to perform in the MSATS web portal.
- Glossary Terms are capitalised and have the meanings listed against them in the [Retail Electricity Market Procedures—Glossary and Framework](#)~~Retail Electricity Market Procedures – Glossary and Framework~~.
- Rules terms are listed in the Rules Terms section.
- References to time are Australian Eastern Standard time (AEST) unless otherwise specified.
- The examples in this document refer to aseXML schema version r25, please refer to the latest version available from the AEMO website.

Chapter 2 Need to Know

National Electricity Rules

- Clauses 7.8.2(d)(2), and 7.8.2(ea) (eb) & (ec)

Related procedures

- **B2B Procedure: Meter Data Process**
- **Metrology Procedures**
- **MDM Procedures**
- **National Electricity Amendment (Five-minute settlement rule) 2017**
- **National Electricity Rules**

Assumed knowledge

This guide assumes you have knowledge of:

- aseXML schemas and csv files
- Metering Data
- The MSATS Web Portal
- The FTP batch interface
- AEMO's E-Hub APIs

User rights access

MDPs must have the appropriate user rights access. The access right determines the functionalities and transactions you can use to access the web portal, batch interfaces, FTP, and API services.

Participant Administrators (PAs) authorise Participant User access in MSATS. The initial PA is set up by the AEMO system administrator as part of the registration process.

To upload Metering Data:

1. The Participant User submitting transactions must have the right to allow full access to the **Participant Mailbox All** entity.
2. The UserID identified in the SecurityContext element in the XML message must have the permission to do batch transactions contained in the XML message (e.g. allocation of a right allowing submission of MDM Metering Data).

To use AEMO's e-Hub APIs MDPs must have API e-Hub registration. For help, see **Guide to AEMO's e-Hub APIs**.

Set participant

Where a Participant User has rights assigned by more than one Participant ID, the Participant User selects the Participant ID they want to represent using the Set Participant option in the MSATS web portal. For help, see Set Participant in the **Introduction to MSATS**.

Chapter 3 About Metering Data Management

What is Metering Data Management

Meter Data Management (MDM) accepts and stores all Metering Data in the National Electricity Market (NEM) submitted by MDPs as a **B2B Procedure: Meter Data Notification (MDN)**. It is the centralised database for Metering Data.

This database stores:

- Profile information AEMO generates internally.
- Data for every Active Data Stream Suffix's in the CATS_NMI_DATA_STREAM table for any period where the Electricity Data Stream/Status = A (Active) against a certain Connection Point for Settlements purposes and UFE analysis.
- Substitutes of missing data.

Who can use

Meter Data Providers (MDPs).

How do you use

MDPs submit the Metering Data in the form of csv payloads wrapped in aseXML under the **MDMT** or **MTRD Meter Data Notification (MDN)** transaction type. MDN transactions go through several validations before AEMO accepts the file.

MDPs deliver Metering Data to AEMO for Settlement processing in the MSATS Web Portal, FTP batch interface, or API. For details, see [Loading Metering Data File Load](#) on page 31.

Chapter 4 Meter Data Messaging Exchange

An MDP acts as the Initiator and AEMO as the Recipient using transactions exchanged for Metering Data. The transactions are Business Documents or Business Signals where:

1. Business Documents are notifications or responses between an MDP and AEMO containing important business information.
2. Business Signals indicate the receipt, acceptance/rejection of a Business Document.
3. Business Documents and Business Signals map onto aseXML Transactions and Acknowledgements respectively.

For more details, see [Related procedures on page 5](#)

Field Code Changed

MDMT messaging exchange

Figure 1 below and Table 1 on page 9 provide an illustration of the interaction between an MDP and AEMO for submitting an MDMT Meter Data Notification.

Figure 1 MDMT sequence diagram

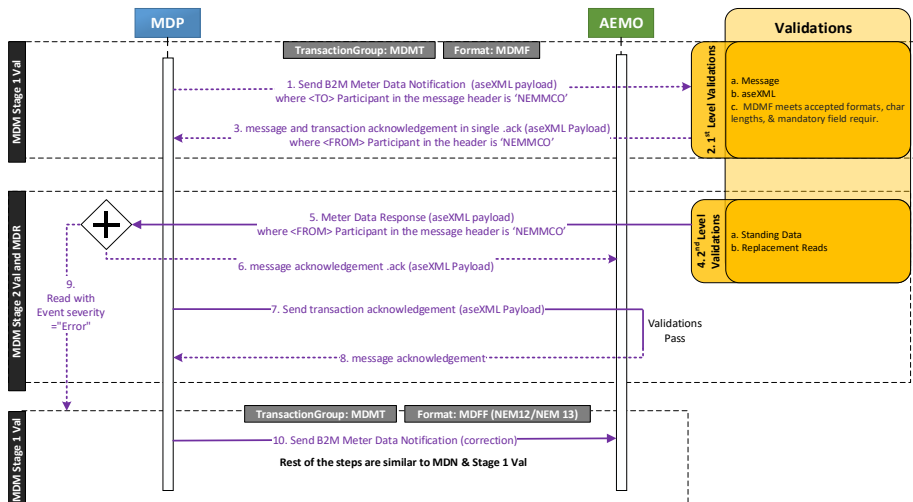

Table 1 MDMT process steps

Step	Process Step Definition	Process Step Type	Comments
1	<p>In the normal processing scenario, the Initiating MDP submits an MDMT Meter Data Notification message with Metering Data to AEMO for B2M market settlements via either of the following methods:</p> <ul style="list-style-type: none"> - MSATS Browser – using the Data Load Import > Participant Inbox screen. - Batch – using the /Inbox file share directory. - B2M Push API – using the B2M submitMessages_API-message resource. - B2M Pull API – using the B2M submitMessages_API message resource. 	MDP / AEMO	<p><TO> Participant in the message header should be set to NEMMCO</p> <p>All recipients including AEMO should receive the message where any party identifies an issue requiring a new version or resending the Metering Data.</p>
2	<p>AEMO performs level 1 validations of the Message, Transaction(s), format of the MDMF CSV Interval or Consumptions file, and submitted meter data</p>	AEMO	<p>AEMO executes the following types of validations:</p> <ul style="list-style-type: none"> - Message - aseXML schema - MDMF meets accepted formats, character lengths, & mandatory field requirements.
3	<p>When the Message passes validation, AEMO generates a positive ase:MessageAcknowledgement and continues with further processing of the aseXML Transaction(s) contained in the message. If the Transaction(s) pass validation, then AEMO generates positive ase:TransactionAcknowledgements.</p>	MDP / AEMO	<p><FROM> Participant in the message header and Transaction Acknowledgement are be set to NEMMCO.</p> <p>The Message and Transaction Acknowledgement(s) are bundled as a single Message Acknowledgement file or payload. Therefore, the MDP does not send acknowledgements to close the Hokey Pokey messaging protocol.</p>
4	<p>AEMO performs level 2 CATS Standing Data and replacement read validations of the meter data submitted within the MDMT Transaction(s)</p>	AEMO	<p>AEMO executes the following types of validations:</p> <ul style="list-style-type: none"> - CATS Standing Data - Replacement Reads

Meter Data Messaging Exchange

Step	Process Step Definition	Process Step Type	Comments
5	AEMO generates and sends a message containing results of the level 2 validations to the Initiating MDP an MDMT Meter Data Response.	MDP / AEMO	<FROM> Participant in the header of the Message and Transaction Acknowledgements must be set to NEMMCO.
6-8	The Initiating MDP validates the MDMT Meter Data Response and exchanges <u>ase:MessageAcknowledgement</u> and <u>ase:TransactionAcknowledgements</u> with AEMO as per the Hokey Pokey messaging protocol	MDP / AEMO	
9-10	AEMO generated MDMT Meter Data Response contains the reads AEMO rejects at level 2 validation process. The MDP creates a new MDMT Meter Data Notification containing corrected Metering Data for the rejected reads only	MDP / AEMO	All parties must receive the notification with corrected data involving a new version of Metering Data.

MDMT validation response

Figure 2 XML MDMT validation response message

1. Schema information
2. Header information
3. Transaction information

```

1 <?xml version="1.0" ?>
  <ase:aseXML xmlns:ase="urn:aseXML:r35"
  xmlns:xsi="http://www.w3.org/2001/XMLSchema-instance"
  xsi:schemaLocation="urn:aseXML:r35 http://www.nemmco.com.au/aseXML/schemas/r35/aseXML_r35.xsd">
2   <Header>
     <From description="Australian Energy Market Operator Limited">NEMMCO</From>
     <To description="SOME MDP Pty">SOMEMDP</To>
     <MessageID>NEMMCO-MSG-781397828</MessageID>
     <MessageDate>2019-01-21T03:13:28+10:00</MessageDate>
     <TransactionGroup>MDMT</TransactionGroup>
     <Priority>Medium</Priority>
     <SecurityContext>NEMMCOBATCH</SecurityContext>
     <Market>NEM</Market>
   </Header>
3   <Transactions>
     <Transaction transactionID="MDMT-781397828" transactionDate="2019-01-21T03:11:59+10:00"
       initiatingTransactionID="MTS_425945373">
       <MeterDataResponse version="r29">
         <ActivityID>17606939</ActivityID>
         <AcceptedCount>305</AcceptedCount>
         <LoadDate>2019-04-16T04:09:47+10:00</LoadDate>
         <Event severity="Error">
           <Code>1084</Code>
           <KeyInfo>15</KeyInfo>
           <Context>7001083735,11,21-MAR-2019,18-JUL-2019,15-APR-2019 18:11:01</Context>
         </Event>
         <Event severity="Error">
           <Code>1084</Code>
           <KeyInfo>36</KeyInfo>
           <Context>7001083754,21,15-JAN-2019,11-APR-2019,15-APR-2019 18:06:06</Context>
         </Event>
         <Event severity="Error">
           <Code>1084</Code>
           <KeyInfo>37</KeyInfo>
           <Context>7001083754,21,12-APR-2019,09-AUG-2019,15-APR-2019 20:03:39</Context>
         </Event>
         <Event severity="Error">

```

Version r29 is correct for this response report under the r35 schema.

- AEMO assigns an ActivityID for processing MDM internally.
- The numeric part of the MessageID and the TransactionID match the numeric part of the file name for an FTP delivered message or messageContextID for an API delivered message.

- The end of the first line in the Transactions element contains the initiating TransactionID the MDP supplies in the MDMT MeterDataNotification transaction. This identifier is the key piece of information for identifying the original transaction for this response.
- The value in the AcceptedCount element is the number of rows AEMO accepts (i.e. loaded) and LoadDate is the date and time MDM loads the accepted data.
- The code within the Event element(s) contains the outcome of the validations.
- For any errors, an Event element i.e. one Event element for each failed Meter Reading displays the summary information.
- The AcceptedCount plus the number of error events should equal the number of submitted reads.

Figure 3 below is an example of three rejected MDMT reads.

Figure 3 MDMT events

```

<Event severity="Error">
  <Code>1084</Code>
  <KeyInfo>275</KeyInfo>
  <Context>RIP0000510,11,16-JAN-2019,15-MAY-2019,15-APR-2019 18:10:15</Context>
</Event>
<Event severity="Error">
  <Code>1089</Code>
  <KeyInfo>279</KeyInfo>
  <Context>RIP0000510,11,16-JAN-2019,15-MAY-2019,15-APR-2019 18:10:14</Context>
</Event>
<Event severity="Error">
  <Code>1099</Code>
  <KeyInfo>280</KeyInfo>
  <Context>RIP0000510,41,16-JAN-2019,15-MAY-2019,15-APR-2019 18:10:14</Context>
</Event>
</MeterDataResponse>
</Transaction>
</Transactions>
</ase:aseXML>

```

The four-digit code in the **Code** element is an error code. Table 2 on page 13 describes the MDMT events error codes

The **KeyInfo** element contains the row number. The first row with Metering Data is row two. Row one is column headings.

The **Context** contains each of the following comma-separated elements:

1. NMI
2. Data Stream
3. Start Date
4. End Date
5. MDP Version Date Time

MDMT event error codes

Table 2 MDMT events error codes

Error Code	Description
1084	Invalid NMI Suffix; Possible causes include invalid CSV data or NMI Suffix for record
1089	There is a record in the system overlapping this record with a Version Date that is after or equal to the Version Date of this record
1099	Read failed as part of Meta-read

A full list of error codes and descriptions are available in the MSATS web portal > Administration > Codes Maintenance > Error Codes or in a CATS C1 report.

MTRD message exchange

Figure 4 on page 14 and Table 3 on page 14 provide details of the interaction between an MDP and AEMO to submit an MTRD Meter Data Notification.

Meter Data Messaging Exchange

Figure 4 MTRD message exchange between MDPs and AEMO

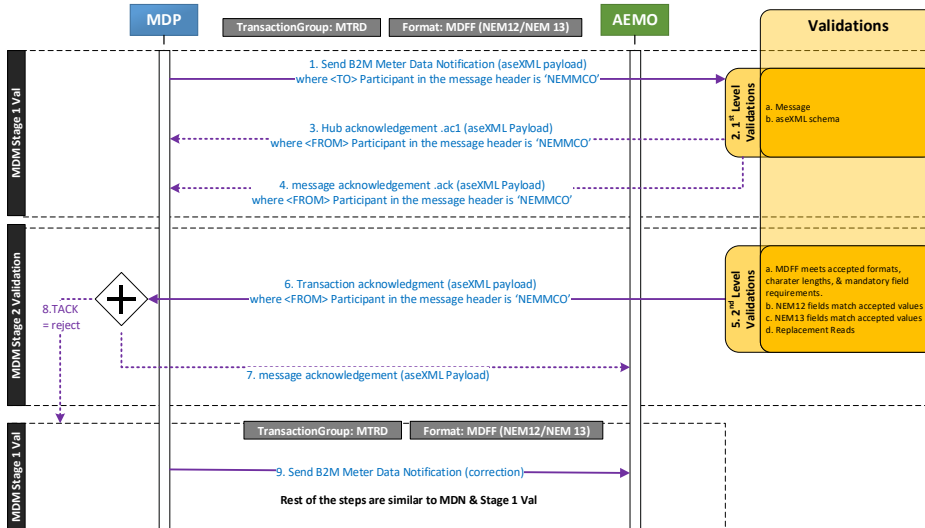

Table 3 MTRD process steps

Step	Process Step Definition	Process Step Type	Comments
1	In the normal processing scenario, the Initiating MDP submits a B2M MTRD Meter Data Notification message with Metering Data to AEMO for B2M market settlements via either of the following methods: <ul style="list-style-type: none"> - MSATS Browser – using the B2B Browser > Upload File screen - Batch – using the /Inbox or B2B/Inbox file share directory - B2B Push API – using the B2MB2B messages API message resource - B2B Pull API – using the B2MB2B messages API message resource 	MDP / AEMO	<TO> Participant in the message header must be set to NEMMCO. MDFF Header record (100) ToParticipant should be set to NEMMCO. All recipients including AEMO must receive this message where any party identifies an issue requiring a new version or resending the Metering Data. The B2B SynchSync API is not available for B2M MTRD Meter Data Notification submissions and errors out if attempted.
2	AEMO performs level 1 validations of the Message and Transaction(s)	AEMO	AEMO executes the following types of validations: <ul style="list-style-type: none"> - Message - aseXML Schema

Meter Data Messaging Exchange

Step	Process Step Definition	Process Step Type	Comments
3	AEMO validates the message, generates and sends it to the Initiating MDP a Hub Acknowledgement.	MDP / AEMO	Definition of Hub Acknowledgement FTP protocol - .ac1 Webservice Protocol – Hub ack payload on API invocation
4	Where the message passes validation, AEMO generates a positive <u>ase:MessageAcknowledgement</u> and continues with further processing of the aseXML Transaction(s) within the Message	MDP / AEMO	<FROM> Participant in the header of the Message Acknowledgement must be to NEMMCO. Definition of message Acknowledgement FTP protocol - .ack Web Service Protocol – ack payload
5	AEMO performs level 2 validations of the MDFF and meter data submitted within the MTRD Transaction(s)	AEMO	AEMO executes the following types of validations: - MDFF meets accepted formats, character lengths, & mandatory field requirements. - NEM12 fields match accepted values. - NEM13 fields match accepted values. - Replacement Reads. Due to potential delays in updating the MSATS web portal, AEMO does not reject MTRD Transactions with the MSATS Standing Data and the information in MDFF file not aligning at the time of receipt.
6	AEMO generates and sends <u>ase:TransactionAcknowledgements</u> to the Initiating MDP containing results of the level 2 validations	MDP / AEMO	<FROM> Participant in the header of the Transaction Acknowledgement must be set to NEMMCO. Where the MDFF format fails structural validations the Message and Transaction Acknowledgement(s) are bundled as a single Message Acknowledgement file or payload so the MDP is not required to send Acknowledgements to close the Hokey Pokey messaging protocol.

Step	Process Step Definition	Process Step Type	Comments
7	The Initiating MDP validates ase:TransactionAcknowledgements and sends an ase:MessageAcknowledgements to AEMO as per the Hokey Pokey messaging protocol	MDP / AEMO	
8-9	AEMO generates ase:TransactionAcknowledgements , which is a reject or partial, the MDP creates a new MTRD Meter Data Notification containing corrected Metering Data for the rejected reads only	MDP / AEMO	Corrected Metering Data must include all NMI suffixes for any IntervalDate in the same transaction.

MTRD Transaction Acknowledgement Validation Response

Figure 5 below is an example of an [ase:TransactionAcknowledgements/@status="Accept"](#) for an MTRD transaction.

Figure 5 XML MTRD Transaction Acknowledgment Accept Validation Response Format

```
<?xml version="1.0" ?>
<ase:aseXML xmlns:ase="urn:aseXML:r36"
xmlns:xsi="http://www.w3.org/2001/XMLSchema-instance"
xsi:schemaLocation="urn:aseXML:r36 http://www.nemmco.com.au/aseXML/schemas/r36/aseXML_r36.xsd">
  <Header>
    <From description="Australian Energy Market Operator Limited">NEMMCO</From>
    <To description="">SOMEMDP</To>
    <MessageID>MTRD-17573704</MessageID>
    <MessageDate>2019-04-10T05:57:20+10:00</MessageDate>
    <TransactionGroup>MTRD</TransactionGroup>
    <Priority>Low</Priority>
    <SecurityContext>NEMMCOBATCH</SecurityContext>
    <Market>NEM</Market>
  </Header>
  <Acknowledgements>
    <TransactionAcknowledgement
      initiatingTransactionID="SOMEMDP-TRAN-MTRD-0002620414"
      receiptDate="2019-04-10T05:57:20+10:00"
      receiptID="MTRD-17573704" status="Accept"/>
  </Acknowledgements>
</ase:aseXML>
```

- AEMO assigns a unique [receiptID](#) for internal MDM processing while receiptDate is the date and time the processing time.
- The numeric part of the MessageID and the TransactionID matches the numeric part of the file name for an FTP delivered message or messageContextID for an API delivered message.

- The end of the first line in the Transactions element contains the initiating TransactionID MDP supplies in the MTRD MeterDataNotification transaction. It identifies the original transaction the ase:TransactionAcknowledgements refers to.
- The code within the Event element(s) contains the outcome of the validations. For MTRD transactions an Event have a severity of either Information or Error:
 - An Event severity of Information indicates an AEMO validation identifies key attributes of the Meter Reading do not validate against CATS Standing Data. While the Meter Reading loads into AEMO's MDM, market settlements does not use the Meter Reading until CATS Standing Data set up is complete. Participants must address the Information without delay by submitting the required CATS Change Requests to setup the CATS Standing Data to support the Meter Reading.
 - An Event severity of Error indicates an AEMO validation identifies that MTRD does not accept the Meter Reading and does not load into AEMO's MDM. MDP must address the Error events without delay by correcting the MDFF (NEM12/NEM13) value(s) causing validation failure and resending the MTRD transaction to AEMO and all entitled Participants.
- An Event element (one Event element for each failed Meter Reading) displays a summary of all rejected Error or Information reads.

Figure 6 on page 18 displays one information read and two rejected error reads for a NEM12 MDFF file.

Figure 6 MTRD Events

```

<?xml version="1.0" ?>
<ase:aseXML xmlns:ase="urn:aseXML:r36"
xmlns:xsi="http://www.w3.org/2001/XMLSchema-instance"
xsi:schemaLocation="urn:aseXML:r36 http://www.nemmco.com.au/aseXML/schemas/r36/aseXML_r36.xsd">
  <Header>
    <From description="Australian Energy Market Operator Limited">NEMMCO</From>
    <To description="">SOMEMDP</To>
    <MessageID>MTRD-17573704</MessageID>
    <MessageDate>2019-04-10T05:57:20+10:00</MessageDate>
    <TransactionGroup>MTRD</TransactionGroup>
    <Priority>Low</Priority>
    <SecurityContext>NEMMCOBATCH</SecurityContext>
    <Market>NEM</Market>
  </Header>
  <Acknowledgements>
    <TransactionAcknowledgement initiatingTransactionID="SOMEMDP-TRAN-MTRD-0002620414"
      receiptDate="2019-04-10T05:57:20+10:00" receiptID="MTRD-17573704" status="Partial">
      <Event severity="Information">
        <EventCode>1085</EventCode>
        <KeyInfo>63</KeyInfo>
        <Context>RIP0000321,E1,03-JAN-2019,,11-JAN-2019 13:14:11</Context>
        <Explanation>Invalid NMI: Possible causes include invalid CSV data or NMI
          has not been established in CATS Standing Data.</Explanation>
      </Event>
      <Event severity="Error">
        <EventCode>1089</EventCode>
        <KeyInfo>192</KeyInfo>
        <Context>RIP0000510,E1,04-JAN-2019,,11-JAN-2019 13:14:11</Context>
        <Explanation>There is a record in the system that overlaps this record
          with a Version Date that is equal to the Version Date of this record.
        </Explanation>
      </Event>
      <Event severity="Error">
        <EventCode>3003</EventCode>
        <KeyInfo>193</KeyInfo>
        <Context>RIP0000321,E1,05-JAN-2019,,11-JAN-2019 13:14:11</Context>
        <Explanation>For a given UOM Type the IntervalValue must meet the format
          and character length.</Explanation>
      </Event>
    </TransactionAcknowledgement>
  </Acknowledgements>
</ase:aseXML>

```

The four-digit code in the **EventCode** element is an error code. Table 4 on page 19 describes the MTRD event error codes.

The **KeyInfo** element contains the row number. Note the first-row number with Metering Data is row 2. Row 1 is column headings.

The **Context** contains the following comma-separated elements:

1. NMI
2. Data Stream
3. Start Date
4. End Date (accumulation meters only)
5. Update Date Time

MTRD events error code

Table 4 MTRD event error codes

Error Code	Description
1085	Represents an information warning Invalid NMI: Possible causes include invalid CSV data or NMI has not been established in CATS Standing Data
1089	Represents the error There is a record in the system that overlaps this record with a Version Date that is equal to the Version Date of this record
3003	Represents the error for a given UOM Type the IntervalValue must meet the format and character length

A full list of error codes and descriptions are available in the MSATS web portal > Administration > Codes Maintenance > Error Codes or [in a CATS C1 report](#).

Chapter 5 Meter Data Management Format (MDMF)

MDMF is a csv meter data format for MDPs to submit Metering Data to AEMO for Market Settlements.

CSV Data Types

The MDMF supports Metering Data for the following csv data types:

- CSVConsumptionData
- CSVIntervalData
- CSVProfileData

MDMF CSVConsumptionData

This data type sends formatted Metering Data for Data Stream Suffixes in the CATS_NMI_DATA_STREAM (CNDS) table with a Data Stream Type = C. The Metering Data is **not** profiled into Trading Intervals.

Each component of the CSVConsumptionData listed in the MDMF ConsumptionData table is comma-separated in the XML file.

To deliver CSVConsumptionData, the content in the Suffix field:

1. Must conform to the **National Metering Identifier Procedure** for consumption Metering Data.
2. Must be identical to the Data Stream value entered in the MSATS CATS_NMI_Data Stream table for the Connection Point the NMI identifies.

Table 5 on page 21 describes the fields in the MDMF CSVConsumptionData transaction.

Note the MDMF components included within the CSVConsumptionData tag.

Formatted: No wrapping

Figure 7 on page 22 is an example of the transaction information in an aseXML MDMT payload to load MDMF accumulation Metering Data.

Table 5 MDMF csv ConsumptionData

Field Name	Field Format	Example
NMI	The NMI, identifying the connection point Maximum 10 alphanumeric characters	8166755454 VSSSS00001
Suffix	The NMI Data Stream Suffix as defined in the National Metering Identifier Procedure	11 42
MDPVersionDate	The date and time the Metering Data loaded into the participant's system yyyymmddhhmmss	2001071408304 5
FromDate	The first day of the Meter Reading period, assumed taken at 00:00 hours yyyymmdd	20010501
ToDate	The last day of the meter reading period, assumed taken at 23.59 hours yyyymmdd	20010731
Status	The quality flag for the Metering Data: - A (Actual); - E (Estimated); - S (Substituted); or - F (Final Substitutions) For details about quality flags, see Metrology Procedure: Part B	A, E, S or F
Reading	This is the actual consumption value in KWh for the period supplied (FromDate to the ToDate) and signed to indicate import or export Meter Reading at (ToDate – FromDate) = consumption reading All values are inclusive of meter multipliers, so all consumption values and Meter Readings are multipliers adjusted Readings in KWh must conform to number(19,4), which means before the decimal there can be up to 15 digits and after it up to 4 digits, resulting in a number that is maximum 19 characters long AEMO does not expect participants to pad with preceding or trailing zeros	✓ 1234567890123 .5678 ✓ 1234567.56 ✗ 1234567890123 45.56789

Figure 7 MDMF CSVConsumptionData transaction information

1. Schema information
2. Header information
3. Transaction information

```

1 <?xml version="1.0"?><ase:aseXML
  xsi:schemaLocation="urn:aseXML:r31
  http://www.nemmco.com.au/aseXML/schemas/r31/aseXML_r31.xsd"
  xmlns:ase="urn:aseXML:r31" xmlns:xsi="http://www.w3.org/2001/XMLSchema-instance">
2 <Header>
  <From>SOMEMDP</From>
  <To>NEMMCO</To>
  <MessageID>SOMEMDP-MSG-M00001327</MessageID>
  <MessageDate>2017-09-12T02:00:00.000+10:00</MessageDate>
  <TransactionGroup>MDMT</TransactionGroup>
  <Priority>Low</Priority>
  <SecurityContext>GATEWAY</SecurityContext>
  <Market>NEM</Market>
  </Header>
3 <Transactions>
  <Transaction transactionID="SOMEMDP-TRAN-MDMT-M00001327"
  transactionDate="2017-09-12T02:00:00.100+10:00">
  <MeterDataNotification version="r25">
  <CSVConsumptionData>NMI,Suffix,MDPVersionDate,FromDate,ToDate,Status,Reading
  1234567890,A1,201709120145,20170821,20171210,E,0
  1234567890,A1,201709120145,20170821,20171210,E,0
  </CSVConsumptionData>
  </MeterDataNotification>
  </Transaction>
  </Transactions>
  </ase:aseXML>

```

MDMF CSVIntervalData

This data type sends AEMO formatted Metering Data for Data Stream Suffixes in the CATS_NMI_DATA_STREAM (CNDS) table with a Data Stream Type = I or P for the following InstallationTypeCodes in the CATS_METER_REGISTER table:

- COMMS1, COMMS2, COMMS3, COMMS4, COMMS4C, COMMS4D, MRAM, MRIM, NCONUML, PROF, SAMPLE, UMCP, VICAMI

To deliver CSVIntervalData to AEMO:

- The content in the Suffix field must conform to the **National Metering Identifier (NMI) Procedure** for interval Metering Data.

- the Data Stream value entered in the MSATS CATS_NMI_Data Stream table for the Connection Point the NMI identifies must be identical.

The Data Stream Suffix identifier for interval Metering Data (for example, **N1**) is a net value for the contributing import and export interval Metering Data flows for the interval meter concerned.

The net value for CSVIntervalData delivered to MDM, must have:

1. The Metering Data in sub-intervals of 30 minutes and be aggregated to 30-minute intervals before delivery.
2. The respective export and import intervals aggregated E – B flows to provide the NET N value, if the Metering Data contains separate export and import Data Streams. Note: the net energy for a Generator is generally negative.

Each component of the CSVConsumptionData listed in the table below should be comma separated in the XML file.

The Meter Readings are broken down into 48 intervals of 30-minute data.

Table 6 MDMF CSVIntervalData

Field Name	Field Format	Example
NMI	The NMI identifying the Connection Point 10 alphanumeric characters	8105157686 8166755454 VSSSS00001
Suffix	The NMI suffix for the Data Stream, described in the NMI Procedure (section 7)	N1 N2
MDPVersionDate	The date and time the Metering Data is loaded into the MDP's system yyyymmddhhmmss	20010714083045
SettlementDate	The Meter Reading date yyyymmdd	20010724

Meter Data Management Format (MDMF)

Field Name	Field Format	Example
Status	<p>Status of the Meter Reading for each 30-minute interval value (there can be 48 A characters included for each Data Stream)</p> <p>Valid values are:</p> <ul style="list-style-type: none"> - A (Actual) - E (Estimated) - S (Substituted) - F (Final Substitutions) <p>For details about quality flags, see Metrology Procedure: Part B</p>	<p>AAAAAAAAAAAAAAAAAAAA AAAAAAAAAAAAAAAAAAAAA AAAAAAAAAA Or AAAAAA SSSSSSSAAAAA AAAAAAAAAAAAAAAAAAAAA AAAAAFFFFAA</p>
Period 1–48	<p>For every 30-minute interval Meter Reading period (1–48), enter the numeric value for consumption, in KWh, up to 4 decimal places</p> <p>AEMO does not expect participants to pad with preceding or trailing zeros</p> <p>Readings in KWh must conform to number(19,4), which means before the decimal there can be up to 15 digits and after it up to 4 digits, resulting in a number that is maximum 19 characters long</p>	<p>✓ 1234567890123.5678</p> <p>✓ 1234567.56</p> <p>✗ 123456789012345.56789</p>
DCTC	The Data Collection Type Code, defined in Table 7 on page 26	COMMS, COMMS4D, COMMS4C, MRIM, PROF, SAMPLE, MRAM VICAMI, UMCP

Figure 8 on page 25 is an example of the transaction information for an aseXML file to load interval Metering Data.

Note the information components included next to the CSVIntervalData section.

Figure 8 MDMF CSVIntervalData transaction information

1. Schema information
2. Header information
3. Transaction information

```

1 <?xml version="1.0"?>
  <ase:aseXML xmlns:ase="urn:aseXML:r25" xmlns:xsi="http://www.w3.org/2001/XMLSchema-
instance" xsi:schemaLocation="urn:aseXML:r25
http://www.aemo.com.au/aseXML/schemas/r25/aseXML_r25.xsd">
2   <Header>
     <From>MDA1</From>
     <To>NEMMCO</To>
     <MessageID>MDA1-MSG-34567856</MessageID>
     <MessageDate>2009-10-31T13:20:10.100+10:00</MessageDate>
     <TransactionGroup>MDMT</TransactionGroup>
     <Priority>Low</Priority>
     <SecurityContext>zz023</SecurityContext>
     <Market>NEM</Market>
   </Header>
3   <Transactions>
     <Transaction transactionID="MDA1-TNS-12343456" transactionDate="2009-10-
31T13:20:10.090+10:00">
       <MeterDataNotification version="r25">
         <CSVIntervalData
Name="Interval">NMI,Suffix,MDPVersionDate,SettlementDate,Status,Period01,Period02,Period03,Pe
riod04,Period05,Period06,Period07,Period08,Period09,Period10,Period11,Period12,Period13,Period1
4,Period15,Period16,Period17,Period18,Period19,Period20,Period21,Period22,Period23,Period24,Pe
riod25,Period26,Period27,Period28,Period29,Period30,Period31,Period32,Period33,Period34,Period3
5,Period36,Period37,Period38,Period39,Period40,Period41,Period42,Period43,Period44,Period45,Pe
riod46,Period47,Period48,DCTC
1234567890,A1,20091010143542,20090415,EEEEEEEEEEEEEEEEEEEEEEEEEEEEEEEEEEEEEEEEEEEEEEEEEE
AAAAAAAAAAAA,3.422,3.825,4.163,3.456,3.979,3.401,3.567,3.556,3.948,3.732,3.743,3.898,3.859,3.
899,3.749,3.396,3.685,3.827,3.448,3.562,3.949,3.465,3.462,3.618,3.699,3.838,3.68,4.158,3.705,4.14
9,3.633,3.514,4.022,4.077,3.916,3.501,3.429,3.796,3.645,3.695,4.079,3.36,3.962,3.432,3.852,3.965,
3.412, 4.002,COMMS</CSVIntervalData>
       </MeterDataNotification>
     </Transaction>
   </Transactions>
</ase:aseXML>

```

MDMF CSVProfileData

This data type supplies profile data for the Controlled Load profile calculation process in relevant jurisdictions.

CSVProfileData sends AEMO formatted Metering Data for Data Stream Suffixes in the CATS_NMI_DATA_STREAM (CNDS) table with a Data Stream Type = P and/or for the following InstallationTypeCode in the CATS_METER_REGISTER table:

- SAMPLE, COMMS4

The exception is a Metering Installation Type Code for a metering installation is a COMMS1, COMMS2, COMMS3, or COMMS4. The equivalent DCTC is COMMS.

Data Collection type codes

The Data Collection Type Codes (DCTC) in Table 7 below are the Metering Installation Type Codes.

Table 7 DCTC Codes

DCTC Code	Metering Installation Type Code
COMMS	COMMS1, COMMS2, COMMS3, COMMS4
COMMS4D	COMMS4D
COMMS4C	COMMS4C
MRIM	MRIM
PROF	PROF
SAMPLE	SAMPLE
MRAM	MRAM
VICAMI	VICAMI
UMCP	UMCP
NCONUML	Not applicable for MDMT

The rules governing the use of DCTC codes:

1. Must be maximum of eight characters.
2. MSATS does not validate the DCTC code against previous file history for the NMI.

Valid combinations of schema and transaction versions

Schema Version	Transaction Version	Interval	Profile	Consumption
r25	r25	DCTC field required	DCTC field required	no DCTC field required

Figure 9 MDMF with DCTC

```

<MeterDataNotification version="r25">
  <CSVIntervalData
    Name="Interval">NMI,Suffix,MDPVersionDate,SettlementDate,Status,Period01,Period02,Period03,Pe
    riod04,Period05,Period06,Period07,Period08,Period09,Period10,Period11,Period12,Period13,Period1
    4,Period15,Period16,Period17,Period18,Period19,Period20,Period21,Period22,Period23,Period24,Pe
    riod25,Period26,Period27,Period28,Period29,Period30,Period31,Period32,Period33,Period34,Period3
    5,Period36,Period37,Period38,Period39,Period40,Period41,Period42,Period43,Period44,Period45,Pe
    riod46,Period47,Period48,DCTC
    1234567890,A1,20091010143542,20090415,EEEEEEEEEEEEEEEEEEEEEEEEEEEEEEEEEEEEEEEEEEEEEEEEEEEE
    AAAAAAAAAAAAAA
    AAAAAAAAAAAAAA,3.422,3.825,4.163,3.456,3.979,3.401,3.567,3.556,3.948,3.732,3.743,3.898,3.859,3.
    899,3.749,3.396,3.685,3.827,3.448,3.562,3.949,3.465,3.462,3.618,3.699,3.838,3.68,4.158,3.705,4.14
    9,3.633,3.514,4.022,4.077,3.916,3.501,3.429,3.796,3.645,3.695,4.079,3.36,3.962,3.432,3.852,3.965,
    3.412, 4.002,COMMS</CSVIntervalData>
  </CSVIntervalData>
</MeterDataNotification>
    
```

Chapter 6 Meter Data File Format (MDFF)

MDFF is a csv meter data format MDPs use to submit the register level Metering Data to AEMO.

MDFF requires MDPs to provide active and reactive energy as separate register level import and export Metering Data.

The MDFF format supports:

- Metering Data delivered for both accumulation and interval meters where interval Metering Data is NEM12 using the CSVIntervalData element.
- Accumulated Metering Data NEM13 using the CSVConsumptionData element within the transaction body of an MTRD transaction.

This format does not support a signed reading.

The specifications for the MDFF format are described in **MDFF Specification NEM12 NEM13**.

MDFF CSVConsumptionData

MDFF CSVConsumptionData is delivered in the NEM13 format according to the **MDFF Specification NEM12 NEM13 Section 5**.

MDFF CSVIntervalData

MDFF CSVIntervalData should be delivered in the NEM12 format according to the **MDFF Specification NEM12 NEM13 Section 4**.

Chapter 7 File Format and Load

FTP file

For MDPs initiating transactions through AEMO's FTP messaging protocol, once all the information in the aseXML file is correct, save and convert into a .zip file. The .zip file must have a name conforming to the standards in the Table 8 below.

Table 8 zip file format

Field Name	Definition	Format
Transaction group	MDMT = MDMT MTRD = MTRD	4 Alphanumeric
Priority	Messages within each priority group are processed in the last modified order h = High m = Medium l = Low: all Metering Data transactions	1 Character
Unique ID	The unique ID participant systems generate	30 Alphanumeric
Participant ID	The submitting participant's Participant ID	
Extension	An XML-wrapped CSV file saved as a .zip file is the only extension AEMO recognises Once recognised the batch handler picks up and processes the file	3 Characters

Formatted: Keep with next, Keep lines together

Formatted: Keep lines together

Formatted: Keep lines together

Formatted: Keep lines together

Formatted: Keep lines together

Example file name

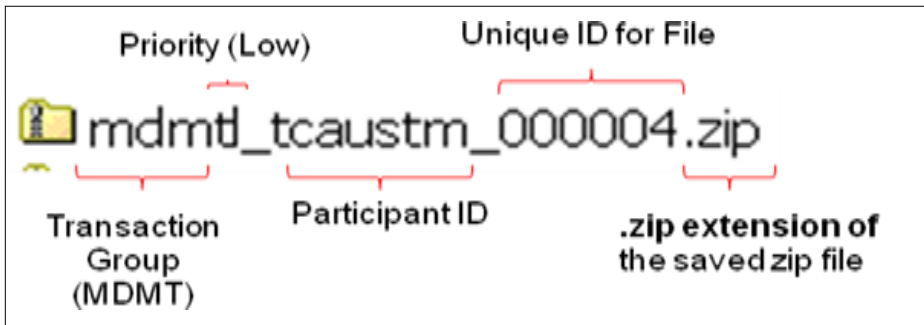

API common header parameters

MDPs initiating transactions through AEMO's e-Hub B2B or B2M API messaging protocol, once all information in the aseXML payload is correct, you must provide a `messageContextID` for the messages exchanged.

The e-Hub uses the `contextID` of the original request when delivering its corresponding acknowledgements. For details, see:

1. **MDMT**: the format of the `messageContextID` is described in the **MSATS 46.96 Release Schedule and Technical Specification - SMS - Meter Data**.
2. **MDMF**: the format of the `messageContextID` is described in the B2B SMP Technical Guide.

When submitting an MDMF message via the e-Hub, the `UserID` identified in the `SecurityContext` element of the header must correspond with the `UserID` of the basic authorisation token used to connect to the B2B Messaging API.

File format by csv data type

For Metering Data, MDPs must create separate transactions for different csv data types. Table 9 describes the file format for an accumulation, interval, or sample meter in each transaction type.

Table 9 file format by csv data type

	MDMT Transaction Type	MTRD Transaction Type
CSV File Format	MDMF	MDFF
CSVConsumptionData Data Type	For each CNDS Data Stream Suffix with a Data StreamType = C Provide the following data to AEMO for accumulated meter data (actual, substituted or estimated) according to the format described in this document	For each CNDS Data Stream Suffix with a Data StreamType = C, Provide the following data to AEMO for accumulated meter data (actual, substituted or estimated). NEM13 format as described in the MDFF Specification NEM12 NEM13 Section 5
CSVIntervalData Data Type	For each CNDS Data Stream Suffix with a Data StreamType = I or P, provision of the following data to AEMO - 30-minute validated interval data (actual, substituted or estimated) according to the format described in this document	For each CNDS Data Stream Suffix with a Data StreamType = I, N or P, provision of the following data to AEMO - 5, 15- or 30-minute validated interval data (actual, substituted or estimated) where all NMI Data Stream Suffix(s) related to an individual NMI are included in the same 100-900 event block for the same IntervalDate. NEM12 format as described in the MDFF Specification NEM12 NEM13 Section 4.
CSVProfileData Data Type	For each CNDS Data StreamSuffix with a Data StreamType = P, provision of the following data to AEMO - 30-minute validated interval data (actual, substituted or estimated)	CSVProfileData Data Type is not supported for this transaction type. MDPs must use the CSVIntervalData Data Type.

Loading Metering Data

Chapter 7 File Load

Transition information

For details about Five Minute Settlement (5MS) transition information, see **MSATS Release Schedule and Technical Specification – 5MS Meter Data**.

Rules for uploading metering data

To upload Metering Data:

1. The Participant ID must match the Participant User's Participant ID.
2. The UserID identified in the SecurityContext element of the header must belong to the Participant ID.

File size

Participants must ensure the messages containing aseXML transactions do not exceed an uncompressed message size of:

- 10 MB for MTRD
- 1 MB for MDMT

An MTRD must not contain more than 1000 bundled transactions, that is:

- One MTRD **Meter Data Notification** file > one message > maximum 1000 transactions.

Delivery points

~~MDPs zip and deliver the aseXML document to AEMO using one of the following methods:~~

- ~~1. **MSATS Web Portal:** Load MDMT Meter Data Notification manually using the MSATS Browser, **Participant Inbox** interface, and the **Upload** action. Follow the steps in the **Upload File** topic in the **Guide to MSATS B2B**.~~

MDPs load MTRD Meter Data Notification manually using the MSATS web browser, **B2B Browser > Upload File**. Follow the steps in the **Data Load Import** topic in the **Guide to MSATS Web Portal**.

2. **E-Hub API:** Load MDMT and MTRD Meter Data Notification using the AEMO B2M e-Hub Asynchronous Push-Push or Push-Pull APIs.

This is the preferred option if the MDP has many files to process. Follow the steps in the **B2B-SMP Technical Guide**.

3. **FTP Batch Interface:** Place MDMT or MTRD Meter Data Notification messages directly into their Participant Inbox Directory on the Participant File Server.

This is the preferred option if an MDP has many files to process. Follow the steps in the **Batch Handler** topic in the **Introduction to MSATS**.

Transaction types

Table 10 describes the transaction type based on the participant and meter type.

Table 10 Metering data transaction

	MDMT Transaction Type	MTRD Transaction Type
Transaction Group	MDM	MTRD
Transaction Type	Meter Data Notification	Meter Data Notification
Initiator	Meter Data Provider	Meter Data Provider
Recipient	AEMO	AEMO Entitled participants (e.g. Retailer, Distributor, Meter Data Provider, or Meter Coordinator)
Meter Type	Interval Accumulation	Interval Accumulation
Delivery Point	MSATS Web Portal FTP Batch Interface B2M Push API B2M Pull API	MSATS Web Portal FTP Batch Interface B2B Push API B2B Pull API

Formatted: Keep lines together

Formatted: Keep with next, Keep lines together

Formatted: Keep lines together

Formatted: Keep lines together

Formatted: Keep lines together

aseXML message format

To import Metering Data into MDM, MDP's systems must generate an XML-wrapped csv file containing all Metering Data and participant information conforming to the relevant aseXML Schema.

The aseXML document contains three sections:

1. Schema Information detailing the MSATS aseXML schema version. Do not modify this information unless there is a schema update. For details, see Figure 10 on page 35.
2. Header Information about the initiating participant, its destination, and the type of transaction (MDMT or MTRD). For details, see Header information on page 37.
3. Transaction Information such as: the Metering Data for loading, depending on the transaction type (for details, see Transaction information on page 38):
 - a. An MDMT Meter Data Notification transaction with a csv MDM format: MDMF.
 - b. An MTRD Meter Data Notification transaction with a csv MDM format: MDFF (NEM12 or NEM13).

Figure 10 below is an example of an aseXML document for the MDMT transaction type containing MDMF csv payload data. The payload shows the structure of a transaction containing accumulated Metering Data.

Figure 10 MDMT aseXML message format

1. Schema information
2. Header information
3. Transaction information

```

1 <?xml version="1.0"?><ase:aseXML xsi:schemaLocation="urn:aseXML:r31
http://www.nemmco.com.au/aseXML/schemas/r31/aseXML_r31.xsd"
2 xmlns:ase="urn:aseXML:r31" xmlns:xsi="http://www.w3.org/2001/XMLSchema-instance">
  <Header>
    <From>SOMEMDP</From>
    <To>NEMMCO</To>
    <MessageID>SOMEMDP-MSG-M00001327</MessageID>
    <MessageDate>2017-09-12T02:00:00.000+10:00</MessageDate>
    <TransactionGroup>MDMT</TransactionGroup>
    <Priority>Low</Priority>
    <SecurityContext>GATEWAY</SecurityContext>
    <Market>NEM</Market>
  </Header>
3 <Transactions>
  <Transaction transactionID="SOMEMDP-TRAN-MDMT-M00001327"
transactionDate="2017-09-12T02:00:00.100+10:00">
    <MeterDataNotification version="r25">
      <CSVConsumptionData>NMI, Suffix, MDPVersionDate, FromDate, ToDate, Status, Reading
      1234567890, A1, 201709120145, 20170821, 20171210, E, 0
      1234567890, A1, 201709120145, 20170821, 20171210, E, 0
    </CSVConsumptionData>
    </MeterDataNotification>
  </Transaction>
</Transactions>
</ase:aseXML>

```

Figure 11 on page 36 is an example of an aseXML document for the MTRD transaction type containing MDFF csv payload data. The payload shows the structure of a transaction containing interval Metering Data in the NEM12 format.

Header information

Table 10 below describes the fields to include in the Header section of the aseXML document.

Table 10 Header information

To avoid MDM rejecting your file, follow the field format where most fields are upper case.

Field Name	Field Format	Example
Description	A description of the MDP submitting the file Maximum 30 characters Not case sensitive	Testing and Certification Australia MDP
From	The Participant ID of the MDP submitting the file Maximum 8 characters Must be upper case	TCAUSTM
To	The AEMO Participant ID Must be upper case	NEMMCO
MessageID	A unique, participant-generated identifier for the file Maximum 50 characters	SOMEMDP-MSG- M00001327 TCAUSTM017746632
MessageDate	Date and time identifier attached to the file yyyy-mm-ddThh:mm:ss.sss+10:00	2019-04- 10T05:55:27.000+10:00
TransactionGroup	The type of transaction	MDMT MTRD
Priority	Transaction priority, determining the order of transaction processing	Low
SecurityContext	Identifies the User ID of the Participant User (MDP) submitting the document	USER1 JSMITH
Market	Identifies the Market as the National Electricity Market (NEM)	NEM

Figure 12 Example of the header section of an aseXML document.

```

<Header>
  <From>SOMEMDP</From>
  <To>NEMMCO</To>
  <MessageID>SOMEMDP-MSG-000222222</MessageID>
  <MessageDate>2019-04-10T05:55:27.000+10:00</MessageDate>
  <TransactionGroup>MTRD</TransactionGroup>
  <Priority>Low</Priority>
  <SecurityContext>GATEWAY</SecurityContext>
  <Market>NEM</Market>
</Header>

```

Transaction information

Table 11 below describes the fields to include in the Transaction section of the aseXML document.

Table 11 Transaction information

Field Name	Field Format	Example
TransactionId	A unique identifier the Participant assigns to the transaction Maximum 50 characters	SOMEMDP-TNS-000222222
TransactionDate	Date and time identifier attached to the transaction yyyy-mm-ddThh:mm:ss.sss+10:00	2019-04-10T05:36:40.000+10:00
MeterDataNotificationVersion	The aseXML schema version currently in use	r35
CSVDataType	Interval Metering Data, accumulation Metering Data, or profile data types For help, see CSV Data Types on page 20	CSVIntervalData Name = Interval CSVConsumptionData Name = Consumption CSVProfileData Name = Profile

Transaction types

Table 12 describes the transaction type based on the participant and meter type.

Table 12 Metering data transaction

	MDMT Transaction Type	MIRD Transaction Type
<u>Transaction Group</u>	<u>MDM</u>	<u>MTRD</u>
<u>Transaction Type</u>	<u>Meter Data Notification</u>	<u>Meter Data Notification</u>
<u>Initiator</u>	<u>Meter Data Provider</u>	<u>Meter Data Provider</u>
<u>Recipient</u>	<u>AEMO</u>	<u>AEMO</u> <u>Entitled participates (e.g. Retailer, Distributor, Meter Data Provider, or Meter Coordinator).</u>
<u>Meter Type</u>	<u>Interval Accumulation</u>	<u>Interval Accumulation</u>
<u>Delivery Points</u>	<ol style="list-style-type: none"> <u>1. B2MMessagingAsync (Push-Push) API (see Guide to NEM Retail B2M APIs)</u> <u>2. B2M Push API or B2M Pull API with the B2MMessagingAsync/submitMessages or B2MMessagingPull/submitMessages endpoint (see Guide to NEM Retail B2M APIs)</u> <u>3. Batch Interface: FTP Gateway and your Participant File Folder, Participant Directory Inbox (see B2M MDMT meter data notification on page 41)</u> <u>4. MSATS Web Portal > Data Load Import > Participant Inbox > Upload (see Guide to MSATS Web Portal)</u> 	<ol style="list-style-type: none"> <u>1. B2BMessagingAsync (Push-Push) API (see B2B SMP Technical Guide)</u> <u>2. B2B Push API or B2B Pull API with the B2BMessagingAsync/messages or B2BMessagingPull/messages endpoint (see B2B SMP Technical Guide)</u> <u>3. Batch Interface: FTP Gateway and your Participant File Folder, Participant Directory Inbox (see B2M MTRD meter data notifications on page 40)</u> <u>4. MSATS Web Portal > B2B Browser > Upload File menu (see Guide to MSATS B2B)</u>

Formatted: Keep lines together

Formatted: Keep with next, Keep lines together

Formatted: Keep lines together

Formatted: Keep lines together

Formatted: Keep lines together

Participant file folder delivery

MDPs zip and deliver the aseXML document to AEMO. Depending on your Participant File Folder structure, it is important to place your prepared B2M **MTRD** Meter Data Notifications in the correct folder. To know where to place your Notification, see the [folder structure options](#) below.

B2M MTRD meter data notifications

MDPs load MTRD Meter Data Notification manually using the MSATS web browser, **B2B Browser** > **Upload File**. Follow the steps in [B2M MTRD meter data notifications](#) above.

/B2B/inbox setup

If you have nominated the /B2B/Inbox setup for your Participant File Folders, you **must** place your MTRD Meter Data Notifications in the **B2B/Inbox**.

Placing your notification in the /Inbox results in AEMO ignoring the file.

For the B2B/Inbox setup, AEMO **always** places acknowledgements in the **/B2B/Outbox**.

```
/B2B
/B2B/Inbox
/B2B/Outbox
/Inbox
/Outbox
/Inbox_archive
/Archive
```

/Inbox setup

If you have nominated the /Inbox setup, place your MTRD Meter Data Notifications in the **/Inbox**.

AEMO places acknowledgements in the **/Outbox**.

```
/Inbox
/Outbox
/Inbox_archive
/Archive
```

Formatted: Default Paragraph Font

B2M MDMT meter data notification

MPDs load MDMT Meter Data Notification manually using the MSATS Browser, **Participant Inbox** interface, and the **Upload** action. Follow the steps in B2M MDMT meter data notification above.

For B2M **MDMT** Meter Data Notifications, regardless of the structure of you Participant File Folders, **always** place your transaction in the /Inbox.

AEMO **always** places acknowledgements in the /Outbox.

/Inbox
/Outbox
/Inbox_archive
/Archive

/B2B
/B2B/Inbox
/B2B/Outbox
/Inbox
/Outbox
/Inbox_archive
/Archive

Chapter 8 Validation

For examples, see Consumption Meter Data Record date relationship examples on page 56.

MDMT validations

Validation of Metering Data is based on alignment between overlapping start and end dates of existing records and MDP version date and time, with exceptions to an existing overlapping Meter Reading with an E – Estimate status.

Validation criteria:

1. Data Streams are active. This includes the duration of the Metering Data for non-interval Data Streams.
2. The MDP must be the Current MDP on the To Date for a non-interval Meter Reading and the Read Date for interval/profile data.
3. The TNI is assigned to a Profile Area.
4. There is no duplicate Metering Data within the input file (NMI, Data Stream, start date, or Meter Reading date of interval date). If there is a duplicate record, the first record is accepted, and all the following records are rejected.
5. Validation of start (1000 days from the submit date) and end date (1000 days from the submit date) for a non-interval Meter Reading. For an interval/profile Meter Reading the date must be no more than 1000 days before the submit date or 1000 days into the future.

MDMT validation of MDPVersionDate

Validation criteria for interval and non-interval Metering Data:

1. The load of any new Metering Data records into MDM and replaces the existing ones for an NMI/Data Stream. It is validated for MDPVersionDate where the MDP Participant ID is the same for both Meter Readings supplied. The MDPVersionDate for the new data record must be greater than the MDPVersionDate of the existing record in MDM.
2. The load of new data records into MDM replaces the existing Metering Data records for an NMI/Data Stream. A different MDP Participant ID supplies the existing data record and MDMT accepts it. MDMT does not undertake any validations against MDPVersionDate in this situation.
3. A separate error code is available for same MDPVersionDate to help distinguish where the MDPVersionDate is less than the record existing in MDM.
4. For meta-reads, MDMT uses the maximum MDPVersionDate of the meta-read. It is the maximum of the MDPVersionDate of all the individual records making up the meta-read. This is then compared with the maximum MDPVersionDate of all the overlapping existing records in MDM in the meta-read start and end date range.

This allows some of the rows in the meta-read to replace records in MDM having a later MDPVersionDate.

As the incoming Metering Data file is created from the MDP's Metering Database, if one or more of them has a later MDPVersionDate than the one in in MDM, all records in the incoming file are the latest.

MDMT validation of Start and End dates of reads (including meta-reads)

The validation of start and end dates of Accumulation Meter Reading records in a single transaction is:

The Estimate Test and the Data Stream Inactive Test are performed against existing Metering data to determine whether they are eligible for use in the start and end date tests. MDPVersionDate is still validated.

1. Sort the Metering Data in the Start Date order.
2. Create a meta-read consisting of all records aligning with each other, and use the Start Date and the End Date of the meta-read for validation (e.g. two Meter Readings – one 1/3 to 31/3, one 1/4 to 30/4, meta-read 1/3 to 30/4) (Overlapped new Meter Readings do not form meta-reads because their dates do not align and are validated as single Meter Readings, each in turn).
3. The start and end dates of the meta-read (which is a single Meter Reading) must either align with existing valid current Meter Readings or fall in periods without current Meter Reading – this allows the new meta-read to fill gaps in the Meter Readings.
4. Estimate Test: Existing Estimates (read type flag = E) are not considered in the Start and End Date validation process of new Meter Readings (regardless of the new Meter Reading being an Estimated Meter Reading).
5. Data Stream Inactive Test: Existing Meter Readings spanning periods the Data Stream is now inactive (due to retrospective changes) are also not considered in the Start and End Date validation process of new Meter Readings (these existing Meter Readings are now effectively invalid due to the Meter Reading spanning an inactive period).
6. If a meta-read fails validation, consider each component of the Meter Reading of the meta-read separately with the above validations.

MDMT data file validations

All submitted MDMT Meter Data Notification data files must pass the MDMT validations in the following tables before they are accepted and loaded into MDM.

MDMT interval data validations

Term	Description
All CSV Fields	No blank fields (no double commas) and valid date formats
Submitting MDP	MDP is the Current MDP for the NMI in CATS on the To Date
NMI, NMI SUFFIX	NMI and NMI suffix must exist in CATS
Period (Readings)	48 numeric values within the string (47 commas) The string should contain no alpha characters (i.e. 0-9, ',' and ':' only)

Validation

Term	Description
Status	Length of string is 1 Can only contain A – Actuals, S – Substitute, F – Final Substitute and E – Estimates
Settlement Date	Valid date format
MDPVersionDate	Valid date format

MDMT ~~Consumption~~consumption data validations

Term	Description
All CSV Fields	No blank fields (no double commas) and valid date formats
Submitting MDP	MDP is the Current MDP for the NMI in CATS on the To Date
NMI, NMI SUFFIX	NMI and NMI suffix must exist in CATS
Reading	Only 1 value within the string (0 commas) The string should contain no alpha characters (i.e. 0-9, ',' and '.' only)
Status	Length of string is 1 Can only contain A – Actuals, S – Substitute, F – Final Substitute and E – Estimates
From Date	Must be a valid date format and between the start date and end date of the NMI Suffix in CATS
To Date	Must be a valid data format and between the start date and end date of the NMI Suffix in CATS

MTRD validations

Validation of Metering Data is based on alignment with overlapping start and end dates of existing records and on the MDP version date and time. Exceptions are where the existing overlapping Meter Reading has an E - Estimate status.

MDM runs the following validation checks before accepting the Metering Data:

1. Where the NMI exists in MSATS, the MDP must be the Current MDP on the To Date for a non-interval Meter Reading and the Read Date for interval/profile data.
2. There is no duplicate Metering Data within the input file (NMI, Data Stream, start date, or Meter Reading date of interval date). If there is a duplicate record, MDM accepts the first record is accepted, and rejects all the following records.
3. Validation of start (1000 days from the submit date) and end date (1000 days from the submit date) for a non-interval Meter Reading. For an interval/profile Meter Reading the date must be no more than 1000 days before the submit date or 1000 days into the future.

MTRD validation of UpdateDateTime

Validation criteria for interval and non-interval Metering Data:

1. The load of any new Metering Data records into MDM, to replace existing Metering Data records for an NMI/Data Stream. MTRD validates it for the UpdateDateTime where the MDP Participant ID is the same for both Meter Readings supplied. The UpdateDateTime for the new data record must be greater the UpdateDateTime of the existing record in MDM.
2. The load of new data records into MDM to replace existing Metering Data records for an NMI/Data Stream where a different MDP Participant ID supplies the existing data record and the MTRD accepts without a validation against UpdateDateTime in this situation.

For meta-reads, MTRD uses the maximum UpdateDateTime (such as the maximum of the UpdateDateTime of all the individual records making up the meta-read). MTRD then compares it with the maximum UpdateDateTime of all the overlapping existing records in MDM in the meta-read start and end date range.

This allows some rows in the meta-read to replace records in MDM with a later UpdateDateTime, as MDP's Metering Database creates the incoming Metering Data file. All records in the incoming file should be the latest if one or more of them has a later UpdateDateTime than in MDM.

MTRD validation of Start and End Dates of reads (including meta-reads)

The validation of start and end dates of Accumulation Meter Reading records in a single transaction is as follows:

1. Sort the Metering Data in the Start Date order.
2. Create a meta-read with all records aligning with each other and use the start date and the end date of the meta-read for validation (e.g. two Meter Readings – one 1/3 to 31/3, one 1/4 to 30/4, meta-read 1/3 to 30/4). Overlapped new Meter Readings do not form meta-reads since their dates do not align and are validated as single Meter Readings, each in turn.
3. The start and end dates of the meta-read (which is a single Meter Reading) must either align with existing valid current Meter Readings or fall in periods where there is no current Meter Reading – this allows the new meta-read to fill in gaps in Meter Readings.
4. Estimate Test: Existing Estimates (read type flag = E) are not considered in the start and end date validation process of new Meter Readings (regardless of whether the new Meter Reading is an Estimated Meter Reading).
5. Data Stream Inactive Test: MTRD does not consider Existing Meter Readings spanning across inactive periods of the Data Stream (due to retrospective changes) in the Start and End date validation process of new Meter Readings (these existing Meter Readings are now invalid due to the Meter Reading spanning an inactive period).
6. If a meta-read fails validation, MTRD considers each component in Meter Reading of the meta-read separately with the above validations.

The Estimate Test and the Data Stream Inactive Test are performed against Metering Data to determine whether they are eligible for use in the start and end date tests. UpdateDateTime validation is still undertaken.

MTRD ~~Data File~~ data file validations

All submitted MTRD Meter Data Notification data files must pass the MDMT validations in the following tables before accepting and loading them into MDM.

MTRD ~~Interval~~ interval data validations

Term	Description
All CSV Fields	The CSV fields in the 100-900 records meet accepted formats, character lengths, and mandatory field requirements as described in the MDFF Specification NEM12 NEM13
Submitting MDP	Where an NMI is set up in the CATS Standing Data, the MDP is the Current MDP for the Meter Reading date for the NMI in CATS
UOM	You must know the UOM. For a target apply UOM for the UOM factor The UOM must match the allowed values in accordance with the MDFF Specification NEM12 NEM13 (Appendix B)
IntervalLength	IntervalLength is a supported Interval
IntervalDate	The IntervalDate must not be greater than 1000 days in the past or future
IntervalValue	For a given UOM Type the IntervalValue must meet the format and character length described in MDFF Specification NEM12 NEM13 (Appendix B) IntervalValue cannot be a null, negative or an exponential value
QualityMethod	QualityMethod has the following format: QMM, where Quality Flag (Q) = 1st character and Method Flag (MM) = 2nd character The value of Quality Flag (the 1st character of QualityMethod) on the 300 th record must match the Quality Flags described in MDFF Specification NEM12 NEM13 (Appendix C) Where the value of the Quality Flag (1st character of QualityMethod) on the 300 th record is V then validation is against the quality flag of QualityMethod populated on the 400 th record The value of the Quality Flag (1st character of QualityMethod) used in the 400 record must match the Quality Flags described in MDFF Specification NEM12 NEM13 (Appendix C) Where the value of Quality Flag (the 1st character of QualityMethod) on the 300 th or 400 th record is not A or N, then the Method Flag (2nd two characters of QualityMethod) are mandatory Where the Method Flag (2nd two characters of QualityMethod) is mandatory it must match the Method Flag described in MDFF Specification NEM12 NEM13 (Appendix D) Only one QualityMethod applies to an Interval

Term	Description
Interval event record (400)	An Interval event record (400) must immediately follow a 300 record where QualityFlag for the 300 th record is V or where the quality flag is A and the reason codes 79, 89, and 61 are used
NMISuffix	The first character of the NMISuffix (E from E1, B from B1) must be known to determine the sign based on the National Metering Identifier Procedure (section 7)

MTRD ~~Consumption Data~~consumption data validations

Term	Description
All CSV fields	The CSV fields in the 100-900 records meet acceptable formats, character lengths, and mandatory field requirements as described in the MDFF Specification NEM12 NEM13
Submitting MDP	Where an NMI is set up in the CATS Standing Data, the MDP is the Current MDP for the Meter Reading date for the NMI in CATS
UOM	The UOM must be known, for a target UOM and for the UOM factor to be applied The UOM must match the values according to the MDFF Specification NEM12 NEM13 (Appendix B)
PreviousRegisterReadDateTime & CurrentRegisterReadDateTime	The PreviousRegisterReadDateTime and CurrentRegisterReadDateTime must not be greater than 1000 days in the past or future
Quantity	For a given UOM Type the Quantity must meet the format and character length described in MDFF Specification NEM12 NEM13 (Appendix B) Quantity cannot be a null or negative value

Term	Description
PreviousQualityMethod	<p>PreviousQualityMethod has the following format: QMM, where Quality Flag (Q) = 1st character and Method Flag (MM) = 2nd character</p> <p>The value of the Quality Flag (1st character of PreviousQualityMethod) on the 250th record must match the Quality Flags described in MDFF Specification NEM12 NEM13 (Appendix C)</p> <p>Where the value of Quality Flag (the 1st character of PreviousQualityMethod) on the 250th record is not A then the Method Flag (2nd two characters of PreviousQualityMethod) are mandatory</p> <p>Where the Method Flag (2nd two characters of PreviousQualityMethod) is mandatory it must match the Method Flag described in MDFF Specification NEM12 NEM13 (Appendix D)</p>
CurrentQualityMethod	<p>CurrentQualityMethod has the following format: QMM, where Quality Flag (Q) = 1st character and Method Flag (MM) = 2nd character</p> <p>The value of the Quality Flag (1st character of CurrentQualityMethod) on the 250th record must match the Quality Flags described in MDFF Specification NEM12 NEM13 (Appendix C)</p> <p>Where the value of Quality Flag (the 1st character of CurrentQualityMethod) on the 250 is not A, then the Method Flag (2nd two characters of CurrentQualityMethod) are mandatory</p> <p>Where the Method Flag (2nd two characters of CurrentQualityMethod) is mandatory it must match the Method Flag described in MDFF Specification NEM12 NEM13 (Appendix D)</p>
DirectionIndicator	DirectionIndicator must be I or E.

MSATS Error Codes (MDM)

All submitted Meter Data Notification files not passing MDMT or MTRD validations prior to data load create an error. See the **Hints and Tips – CATS & NMI Discovery** for more details about common error codes.

Validation failure error codes (MDM)

You can find error codes relating to validation failures of MDM Metering Data files in the MSATS web portal > **Administration** > **Codes Maintenance** > **Error Codes**.

Chapter 9 Rules Terms

The following rules terms are used throughout this guide.

Rules Terms
AEMO
Accumulation Metering Data
Connection Point
Energy
Generator

Rules Terms
Interval Metering Data
Market Settlements
Meter
Metering Data
Metering Installation
Metrology Procedure

Rules Terms
NEM
NMI
Profile
Rules
Settlements
Trading Interval

Chapter 10 Needing Help

Support hub

For non-urgent issues, normal coverage is 8:00 AM to 6:00 PM on weekdays, Australian Eastern Standard Time (AEST).

IT assistance is requested through one of the following methods:

- Phone: 1300 AEMO 00 (1300 236 600)
- ~~Contact Us~~[Contact Us](#) form on AEMO's website

AEMO recommends participants call AEMO's Support Hub for all urgent issues, if you have logged a call in the Customer Portal.

Formatted: Lock anchor, Position: Horizontal: 2.21 cm, Relative to: Page, Vertical: 0.34 cm, Relative to: Paragraph

Information to provide

Please provide the following information when requesting IT assistance from AEMO:

- Your name
- Organisation name
- Participant ID
- System or application name
- Environment: production or pre-production
- Problem description
- Screenshots

Chapter 11 References

Rules and law

~~The **National Electricity Law:** <https://www.aemc.gov.au/regulation/legislation>~~

~~AEMO's website~~

~~Hints and Tips — CATS & NMI Discovery:~~

~~<https://www.aemo.com.au/Electricity/National-Electricity-Market-NEM/Retail-and-metering/Market-Settlement-and-Transfer-Solutions>~~

~~**NMI Procedure:** <https://www.aemo.com.au/Electricity/National-Electricity-Market-NEM/Retail-and-metering/Market-Settlement-and-Transfer-Solutions>~~

~~Retail Electricity Market Procedures — Glossary and Framework:~~

~~<https://www.aemo.com.au/Electricity/National-Electricity-Market-NEM/Retail-and-metering>~~

~~**B2B SMP Technical Guide:** <https://www.aemo.com.au/Electricity/National-Electricity-Market-NEM/Retail-and-metering/Business-to-business-procedures>~~

~~**National Electricity Law:** <https://www.aemc.gov.au/regulation/legislation>~~

~~**National Electricity Rules (NER):** <https://www.aemc.gov.au/regulation/energy-rules/national-electricity-rules>~~

~~**National Energy Retail Rules:** <https://www.aemc.gov.au/regulation/energy-rules/regulation>~~

~~AEMO's website~~

~~**B2B SMP Technical Guide:** Provides participants with the technical specifications for the delivery of B2B Transactions using the e-Hub APIs to assist participants developing their own systems to utilise these APIs.~~

~~**Guide to AEMO's e-Hub APIs:** [https://aemo.com.au/-/media/Files/Electricity/NEM/IT-Systems-and-Change/2018/Provides details about using AEMO's e-Hub as an interface to communicate information with AEMO. It assists wholesale electricity and gas participants developing their own API gateways.](https://aemo.com.au/-/media/Files/Electricity/NEM/IT-Systems-and-Change/2018/Provides%20details%20about%20using%20AEMO's%20e-Hub%20as%20an%20interface%20to%20communicate%20information%20with%20AEMO.%20It%20assists%20wholesale%20electricity%20and%20gas%20participants%20developing%20their%20own%20API%20gateways.)~~

Guide to AEMOs eHub APIs.pdf to Electricity Retail Market Procedures: Contains a dictionary of terms and a full list of NEM procedures, guidelines, and supporting documents.

Guide to MSATS B2B: [https://www.aemo.com.au/Electricity/National-Electricity-Market-NEM/Retail-and-metering/Market-Settlement-and-Transfer-Solutions-System-\(MSATS\)](https://www.aemo.com.au/Electricity/National-Electricity-Market-NEM/Retail-and-metering/Market-Settlement-and-Transfer-Solutions-System-(MSATS)). Provides information about the B2B e-Hub functions available in the Market Settlement and Transfer Solutions System (MSATS).

Guide to MSATS Web Portal: [https://www.aemo.com.au/Electricity/National-Electricity-Market-NEM/Retail-and-metering/Market-Settlement-and-Transfer-Solutions-Solution-\(MSATS\)-web-portal](https://www.aemo.com.au/Electricity/National-Electricity-Market-NEM/Retail-and-metering/Market-Settlement-and-Transfer-Solutions-Solution-(MSATS)-web-portal). Provides assistance using the Market Settlement and Transfer Solutions Solution (MSATS) web portal.

Introduction to MSATS: <https://www.aemo.com.au/Electricity/National-Electricity-Market-NEM/Retail-and-metering/Market-Settlement-and-Transfer-Solutions>

Guide to NEM Retail B2M APIs: Explains how to build B2M retail metering APIs.

Introduction to MSATS: An introduction to using the Market Settlement and Transfer Solutions (MSATS) web portal and batch interfaces.

MSATS-CATS Hints and Tips and NMI Discovery: provides hints and tips on how to ensure NMI Discovery and NMI Detail requests are successful. It also explains MSATS validations.

National Metering Identifier Procedure: Sets out the structure for National Metering Identifiers (NMIs) used in the National Electricity Market (NEM) and details metering data streams for each category of installation.

Retail Electricity Market Procedures – Glossary and Framework: Assists participants to understand the overall MSATS framework. It also contains a dictionary of terms used in the Retail Electricity Market Procedures and a full list of NEM procedures, guidelines and documents.

Appendix 1 Consumption Meter Data Record date relationship examples

Example 1 - One existing metering data record loads into MDM

The following examples assume the Data Stream is active for the entire period.

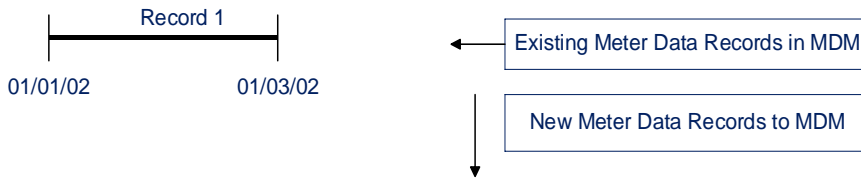

Example 1 scenarios

	Scenario	Loads?	Details
4.5	01/01/02 to 01/04/02	✓	The existing record is archived to history
2.6	29/12/01 to 01/04/02	✓	The existing record 1 is archived to history. In this case the start date of new record is before the start date of the existing record and the end date of the new record is after the end date of the existing record
3.7	05/02/02 to 01/01/02	✓ If record 1 is a forward estimate	In this example the start date of the new record is after the start date of the existing record and so fails validation.

Scenario	Loads?	Details
4.8 	✓ If record 1 is a forward estimate	In this example the start date of the new record is after the start date of the existing record The end date of the new record is before the end date of the existing record and therefore fails validation

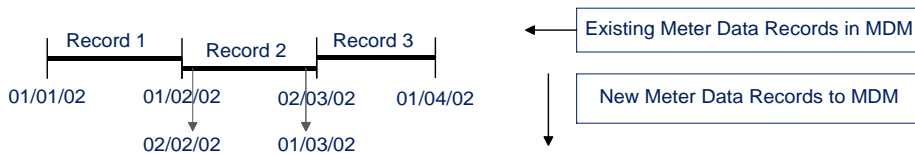

Example 2 - Three existing metering data records loaded into MDM 1

The following examples assume the Data Stream is active for the entire period.

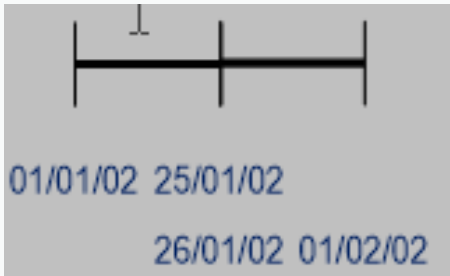

Example 2 scenarios

Scenario	Loads?	Details
1. 	✓ If record 2 is a forward estimate	Because there is no date continuity to record 3 The data gap is 21/02/02 – 01/03/02
2. 	✓ ▪ If record 3 is a forward estimate	Record 3 read_type_flag = 'E'. The new record replaces the previous records 1,2, and 3
3. 	✓	Replaces the previous records 1, 2, and 3

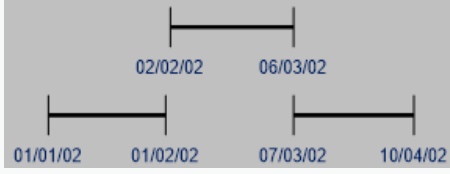
	Scenario	Loads?	Details
4.	 <p>01/01/02 25/01/02</p>	<p>✓</p> <p>If record 1 is a forward estimate</p>	<p>There is no date alignment with Record 1</p> <p>The data gap is 26/1/02 – 1/2/02</p>
5.	 <p>01/01/02 25/01/02</p> <p>26/01/02 01/02/02</p>	<p>✓</p> <p>If record 1 is an estimate</p>	<p>If the meta-read validation fails, each meta-read record is validated separately</p> <p>These examples fail as they do not align with existing records. Unless record 1 is an estimate, then both records load</p>
6.	 <p>01/01/02 01/02/02</p>	<p>✓</p>	<p>Replaces the previous record 1, if the version date is greater than the existing record</p>
7.	 <p>01/01/02 01/02/02 02/02/02 06/03/02 07/03/02 10/04/02</p>	<p>✓</p>	<p>New records replace existing records 1,2, and 3</p> <p>If the meta-read validation fails, each meta-read record is validated separately</p> <p>Record 1 loads if it passes the MDPVersionDT test</p> <p>Records 2 and 3 fail as they do not align with the existing records, unless records 2 and 3 are estimates</p>

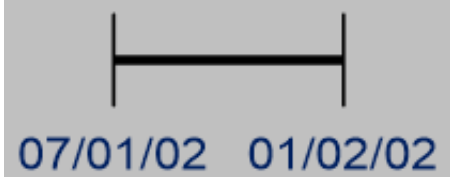
Scenario	Loads?	Details
8. 	✓ If record 1 is an estimate	There is no start date alignment with record 1

Example 3 - Three existing metering data records loaded into MDM 2

The following examples assume that the Datastream is active for the entire period:

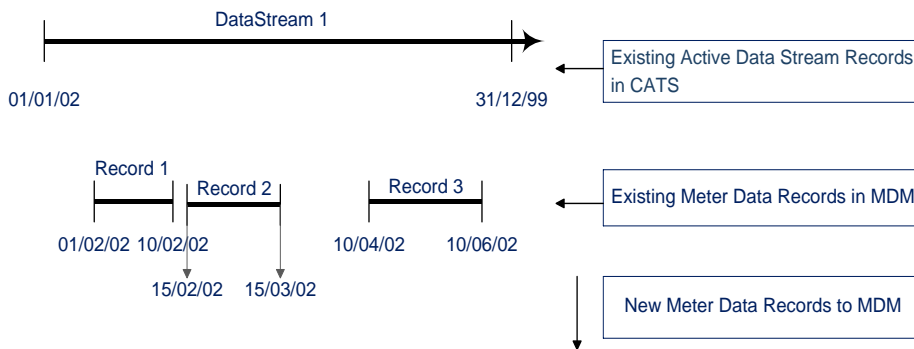

Example 3 scenarios

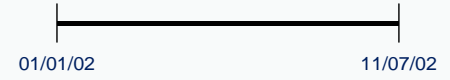
Scenario	Loads?	Details
1. 	✓	The 3 existing records are archived to history As the start date and end date of the new record do not overlap any existing records, there is no requirement for alignment of dates

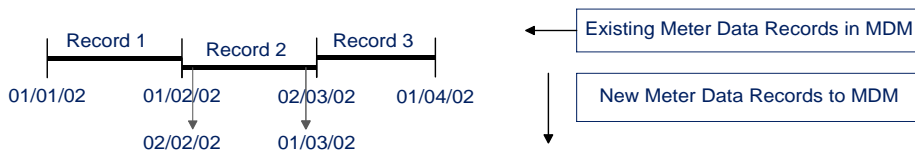

Scenario	Loads?	Details
2. 01/02/02 11/07/02	✓	The 3 existing records are archived to history As the new record start date overlaps the first existing record, there is a requirement for alignment of start dates
3. 01/02/02 09/06/02	✓ If record 3 is an estimate	The end date of the new record overlaps the existing record 3 where the forward estimate means read_type_flag = 'E' If record 3 is a forward estimate, the new record replaces previous records 1, 2, and 3

Example 4 - Overlapping Meter Readings in a transaction

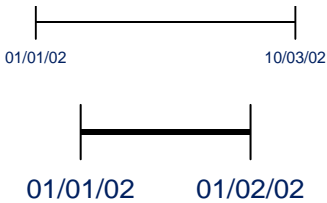

Example 4 scenarios

Scenario	Loads?	Details
1. 02/02/02 25/02/02	✓ If record 2 is an estimate	There is no data continuity to replace record 2 The data gap is 26/2/02 – 1/3/02

Scenario	Loads?	Details
2. 	✓ If record 3 is an estimate	The Read_type_flag = E and its MDPVersionDate is greater than the max of MDPVersionDate of the 1st 2 existing records Record 2 does not load as it is a duplicate record in the file
3. 	✓ If the 1 st new read is an estimate	Record 1 loads and record 2 does not load, unless the first new read is an estimate and has an MDP Version ID less than record 2 The start and end dates are INCLUSIVE, meaning the start of a subsequent record must be 1 day after the end date of the previous record



Example 5 - One existing metering data record loaded into MDM

1

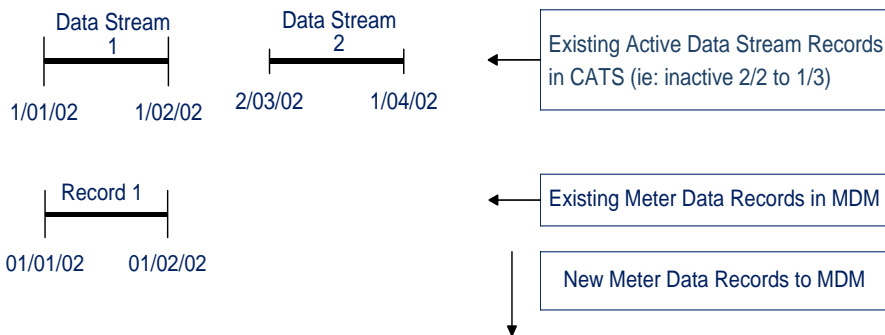
The following examples assume the Data Stream is inactive for the entire period.



Example 5 scenarios

Scenario	Loads?	Details
 <p>01/01/02 20/02/02</p>	✘	Does not load as the Data Stream is inactive at the end date
 <p>01/03/02 10/03/02</p>	✘	Does not load as it spans the period where the Data Stream is inactive at the start date of the record





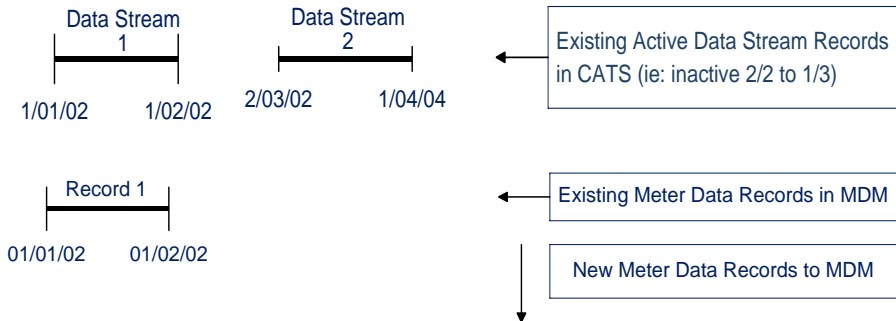







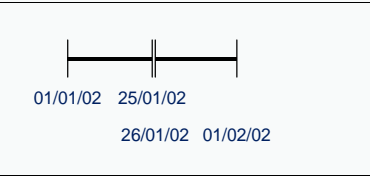

Example 6 - One existing metering data record loaded into MDM 2

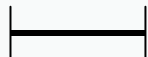
The following examples assume the Data Stream is inactive for the entire period.



Example 6 scenarios

Scenario	Loads?	Details
 <p>01/01/02 10/04/02</p>	✘	Does not load as it spans the period where the Data Stream is inactive

	Scenario	Loads?	Details
2.	 01/01/02 25/01/02	 If the existing record is an estimate	Read_type_flag = E
3.	 01/01/02 25/01/02 26/01/02 01/02/02		New records replace the existing record If the meta-read validation fails, the individual records of the meta-read are validated separately so the records do not load as they do not align with the existing record
4.	 01/01/02 01/02/02		Replaces the existing record 1 if the version date is greater than existing record
5.	 07/03/02 10/04/02		Loads as the new record doesn't overlap any existing record There is a gap in the Metering Data for the period where the Data Stream is inactive and up to 6/3/02
6.	 07/01/02 01/02/02	 If record 1 is an estimate	Otherwise the new record doesn't align with the start date of the existing record
7.	 15/01/02 31/01/02	 If record 1 is an estimate	Otherwise the new record doesn't align with the start date of the existing record
8.	 02/02/02 25/02/02		Spans a period where the Data Stream is inactive

	Scenario	Loads?	Details
9.	 05/02/02 25/03/02	✘	Spans a period where the Data Stream is inactive

Example 7 - One existing metering data record loaded into MDM now spanning a period of inactive Data Stream



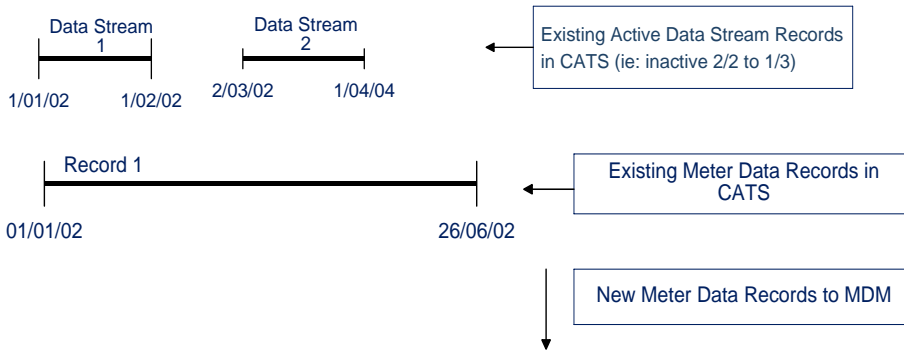

The following examples assume the Data Stream is inactive for the entire period.

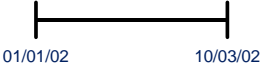

As record 1 spans a period where the Data Stream is now inactive, it is viewed as an invalid Meter Reading, and therefore is not included in any validation and will have the same impact on any new record loading result as if the record did not exist.

Example 7 scenarios

	Scenario	Loads?	Details
1.	 1/01/02 20/02/02	✘	The Data Stream is inactive at the end date

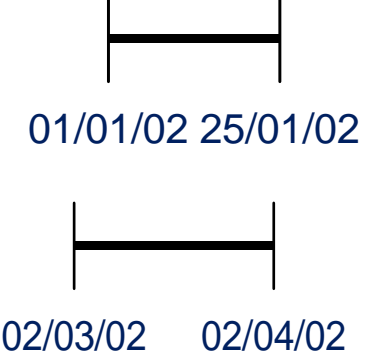
	Scenario	Loads?	Details
2.	 <p>01/01/02 10/03/02</p>	✘	Spans a period where the Data Stream is inactive
3.	 <p>01/01/02 01/02/02</p>	✔	An existing record spanning 1/1 to 26/6 is archived to the history table
4.	 <p>05/01/02 01/02/02</p>	✔	The existing record is not validated against as it because it is an invalid record spanning the period where the Data Stream is inactive
5.	 <p>01/01/02 30/01/02</p>	✔	The existing record spanning 1/1 to 26/6 is archived to the history table. The existing record is not validated since the existing read is invalid
6.	 <p>01/01/02 25/01/02</p> <p>02/03/02 02/04/02</p>	✔	<p>Both records load even though a gap exists between 25/1 and 1/2. The existing record spanning 1/1 to 26/06 is archived to the history table</p> <p>May have different MDPs In the future for these two active Data Stream periods</p> <p>The existing read is invalid, so it is NOT validated against</p>

	Scenario	Loads?	Details
7.	<p>01/01/02 01/02/02</p> <p>05/03/02 02/04/02</p>	✓	The existing record spanning 1/1 to 26/06 is archived to the history table

Formatted: Font: 12 pt

Example 8 - One existing metering data record loaded into MDM now spanning a period of inactive Data Stream

The following examples assume the Data Stream is now inactive for the entire period, but has no gaps.

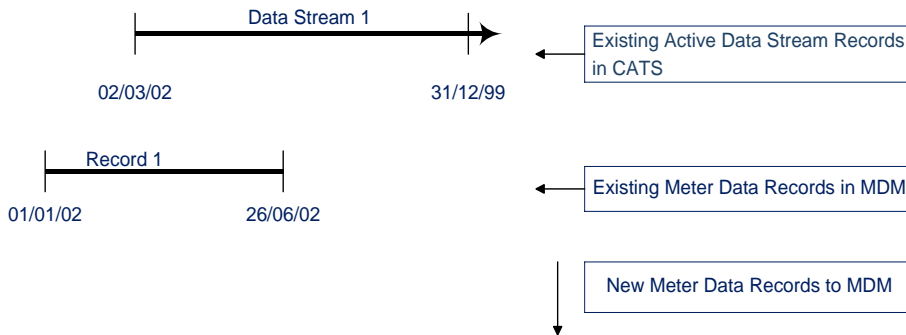

Example 8 scenarios

Scenario	Loads?	Detail
<p>1.</p> <p>01/01/02 20/02/02</p>	✓	Loads as the Data Stream is inactive at the start or end date
<p>2.</p> <p>02/03/02 20/03/02</p>	✓	The existing record spanning 1/1 to 26/6 is archived to the history table The existing read is invalid, so it is not validated

Formatted: Font: Not Bold

Formatted: Font: Not Bold

Example 9 - Data load in the first period of active Data Stream where existing metering data record loaded into MDM for second period of active Datastream

The following examples assume the Data Stream is inactive for the entire period.

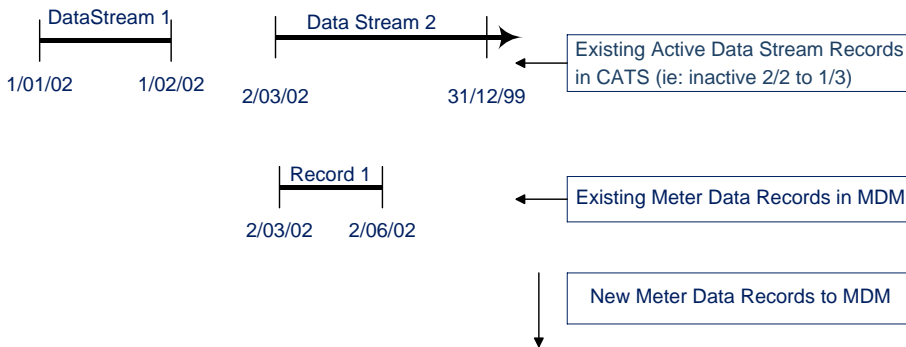

Example 9 scenarios

Scenario	Loads?	Details
<p>1.</p> <p>01/01/02 10/02/02</p>	✘	The Data Stream is inactive at the end date
<p>2.</p> <p>01/01/02 10/01/02 11/01/02 10/02/02</p>	✔ ✘	The 1st record loads . The 2nd record does not load as the Data Stream is inactive at the reading end date
<p>3.</p> <p>05/03/02 10/05/02</p>	✔	If the existing Meter Reading is an estimate. The new record start date does not align with the overlapping existing record start date

Formatted: Font: Not Bold

Formatted: Font: Not Bold

Example 10 - Data load in the first period of active Data Stream where existing metering data record loaded into MDM

The following examples assume the Data Stream is inactive for the entire period.

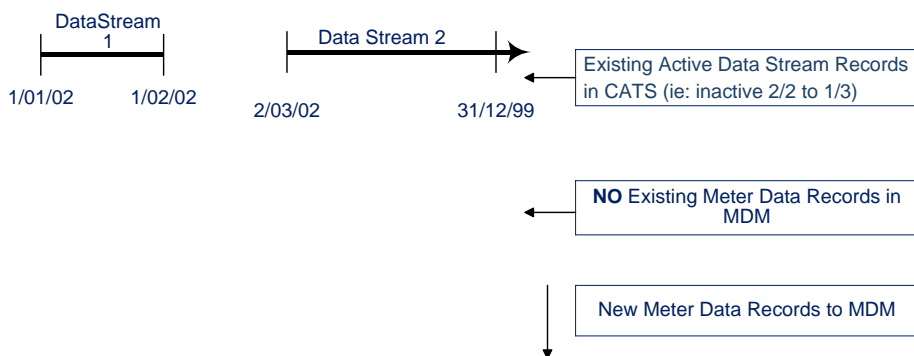

Example 10 scenarios

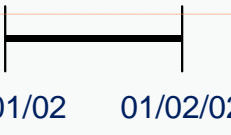
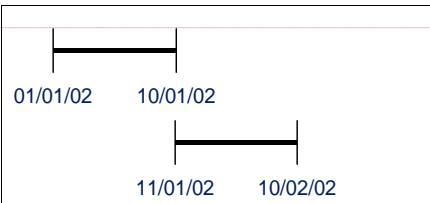
Scenario	Loads?	Details
1. 	✓	loads
2. 	✓ ✗	The 1st record loads . The 2nd record does not load as the Data Stream is inactive at the end date of the record

Formatted: Font: Not Bold

Formatted: Font: Not Bold



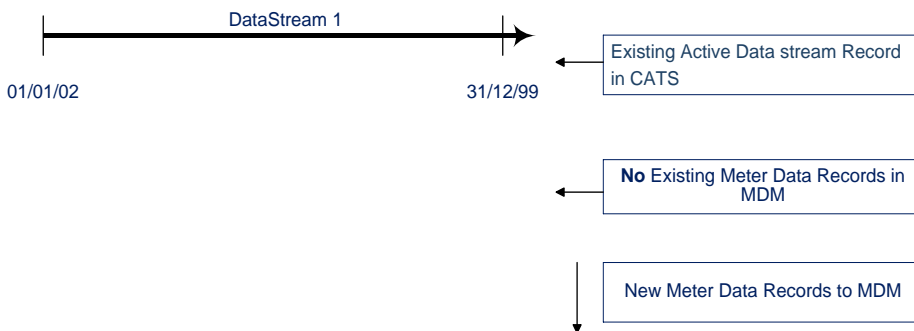

Example 11 - No existing metering data records loaded into MDM

The following records are all in one Metering Data file and assume the Data Stream is active for the entire period.



Example 11 scenarios

The following records are in the one metering data file.

Scenario	Loads?	Details
1  01/02/02 01/04/02	✓	Processed on a record-by-record basis
2  02/03/02 01/05/02	✗	Does not align with the previous loaded record
3  02/04/02 01/06/02	✓	Processed on a record-by-record basis
4  02/05/02 01/07/02	✗	Does not align with the previous loaded record
5  02/06/02 02/08/02	✓	Creates one meta-read
6  03/08/02 02/09/02	✓	Creates one meta-read

Scenario	Loads?	Details
7 	✓	Creates one meta-read

Example 12 - Existing metering data records loaded into MDM

The following examples assume the Data Stream is active for the entire period. Existing records are estimates.

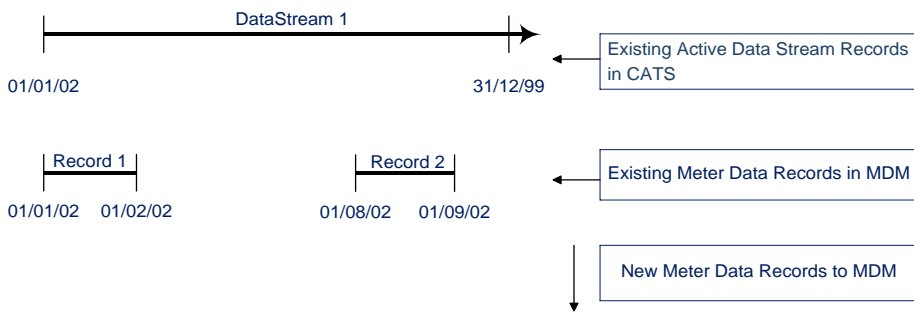

Example 12 scenarios

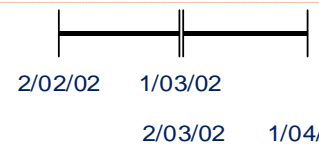
Scenario	Loads?	Details
1 	✓	Loads
2 	✓	The data gap still exists between 2/4/02 and 31/7/02

Formatted: Font: Not Bold

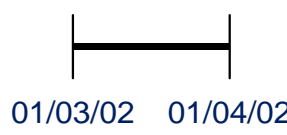
	Scenario	Loads?	Details
3	 <p>15/01/02 01/03/02</p>	✘	The new record does not align with the existing record and record 1 is not an estimate
4	 <p>01/03/02 01/04/02</p>	✔	The data gap still exists between 2/2/02 and 28/2/02, and 2/4/02 and 31/7/02

Index

/

/B2B/Inbox setup, 40
/B2B/Outbox, 40
/Inbox, 41
/Inbox setup, 40
/Outbox, 41

1

1084, 13
1089, 13
1099, 13

A

AcceptedCount, 12
ActivityID, 11
ase:MessageAcknowledgement, 9
ase:TransactionAcknowledgements, 17
ase:TransactionAcknowledgements, 9
aseXML Guidelines, 2
aseXML message format, 34
aseXML Schema, 2

B

B2B Mapping to aseXML, 2
B2B Procedure: Meter Data Process, 2
B2M MDMT meter data notification, 41
B2M MTRD Meter Data Notification, 14
B2M MTRD meter data notifications, 40

C

CATS C1 report, 19
CATS_METER_REGISTER table, 22
CATS_NMI_DATA_STREAM (CNDS) table, 20
Code element, 12
Context, 13, 19
csv data types, 20
CSVConsumptionData, 20
CSVIntervalData, 20, 23
CSVProfileData, 20

D

Data Stream Suffixes, 20

Delivery Points, 39

E

Event, 17
Event element, 12, 17
Event severity of Error, 17
Event severity of Information, 17
EventCode element, 18

F

File size, 32
FTP messaging protocol, 29
FTP protocol, 15

H

header section of an aseXML document, 38
Hokey Pokey messaging protocol, 9
Hub Acknowledgement, 15

I

Initiator, 8
Invalid NMI Suffix, 13

K

KeyInfo, 12
KeyInfo element, 18

M

MDFF Specification NEM12 NEM13, 2
MDM Procedures, 3
MDMF csv ConsumptionData, 21
MDMF CSVConsumptionData transaction information, 22
MDMT aseXML message format, 35
MDMT consumption data validations, 45
MDMT data file validations, 44
MDMT events error codes, 12
MDMT interval data validations, 44
MDMT Meter Data Notification, 8
MDMT process steps, 9
MDMT transaction type, 35
MDMT Transaction Type, 39

messageContextID, 16
MessageID, 11, 16
messaging protocol, 30
Metrology Procedures, 3
MSATS 46.96 Release Schedule and Technical
Specification - SMS - Meter Data, 3
MTRD aseXML message format, 36
MTRD consumption data validations, 49
MTRD data file validations, 48
MTRD event error codes, 18
MTRD Events, 18
MTRD interval data validations, 48
MTRD Message Exchange, 13
MTRD process steps, 14
MTRD Transaction Acknowledgment, 16
MTRD transaction type, 35
MTRD Transaction Type, 39
MTRD validation of UpdateDateTime, 46
MTRD validations, 46

N

National Metering Identifier Procedure, 3

P

Participant File Folder, 40
Participant file folder delivery, 40
place your prepared B2M MTRD Meter Data
Notifications in the correct folder, 40

R

reason codes, 49

receiptID, 16
Recipient, 8
rejected MDMT reads, 12

S

Set participant, 6

T

the Metering Installation Type Code, 26
Transaction information, 38
TransactionID, 11, 16

V

Validation, 42
Validation for interval and non-interval Metering Data,
43
validation of start and end dates, 43
validation of Start and End Dates, 47
validation of start and end dates of Accumulation
Meter Reading, 47

W

Webservice Protocol, 15

X

XML MDMT validation response message, 11