



# SYSTEM STRENGTH IMPACT ASSESSMENT GUIDELINES

PREPARED BY: Systems Capability, [AEMO](#)  
VERSION: 0.24  
EFFECTIVE DATE: [14<sup>th</sup> May](#) 2018  
STATUS: For consultation

**Approved for distribution and use by:**

APPROVED BY: Damien Sanford  
TITLE: Executive General Manager

DATE: [5-14 May](#) 2018

# VERSION RELEASE HISTORY

Version	Effective Date	Summary of Changes
0.1	5 March 2018	Draft for consultation
<a href="#">0.2</a>	<a href="#">14 May 2018</a>	<a href="#">Updated draft following first stage of consultation</a>

## CONTENTS

<b>1. INTRODUCTION</b>	<b>5</b>
1.1 Purpose	5
1.2 Definitions and interpretation	5
1.3 Related documents	6
1.4 Context	6
<b>2. BACKGROUND</b>	<b>8</b>
2.1 AEMO	9
2.2 TNSPs	9
2.3 NSPs	9
2.4 Applicants	10
2.5 Relationship with other processes and documents	10
<b>3. ADVERSE SYSTEM STRENGTH IMPACT</b>	<b>11</b>
3.1 Defining adverse system strength impact	11
3.2 Identifying an adverse system strength impact	12
3.3 Identifying Committed Projects	13
<b>4. SYSTEM STRENGTH IMPACT ASSESSMENT PROCESS</b>	<b>13</b>
4.1 Preliminary Assessment	13
4.2 Full Assessment	16
4.3 Scenario selection	20
<b>5. MITIGATION MEASURES</b>	<b>22</b>
5.1 System strength connection works	22
5.2 System strength remediation schemes	22
5.3 The use of dispatch constraints in the management of system strength	24
<b>APPENDIX A. PRACTICAL EXAMPLES</b>	<b>25</b>
A.1 Defined terms	25
A.2 Preliminary Assessment	25
A.3 Full stability impact assessment	28
<b>APPENDIX B. CHOICE OF SCR AS THRESHOLD FOR PRELIMINARY ASSESSMENT</b>	<b>39</b>
B.1 Methodology	39
B.2 Simulation results	39
B.3 Summary and conclusions	41
<b>APPENDIX C. CONSIDERATION OF FACTS DEVICES DURING PRELIMINARY ASSESSMENT</b>	<b>42</b>
C.1 Methodology	42
C.2 Simulation results	42
C.3 Summary and conclusions	46
<b>TABLES</b>	
Table 1 Glossary of terms and abbreviations	5
Table 2 Related documents and links	6
Table 3 Defined terms	25

Table 4	SCR values with and without a proposed connection	29
Table 5	Summary of results	30
Table 6	System data used for the study	33

## FIGURES

Figure 1	Interrelationship of System Security Market Framework components	7
Figure 2	System strength framework in the NER	8
Figure 3	Calculation of local AG impact on connection point capability	26
Figure 4	Study on impact of new AG (shaded) on Tasmanian power system	27
Figure 5	Assessment of available fault level at six Tasmanian busbar locations (new AG at N1 220)	28
Figure 6	Single line diagram of substation under study	29
Figure 7	Dynamic behaviour of sub network pre-AG2 connection	31
Figure 8	Dynamic behaviour of sub network pre-AG2 connection	31
Figure 9	Dynamic behaviour of sub network pre-AG2 connection	31
Figure 10	Dynamic behaviour of sub network post-AG2 connection	32
Figure 11	Dynamic behaviour of sub network post-AG2 connection	32
Figure 12	Dynamic behaviour of sub network post-AG2 connection	32
Figure 13	Network under study	33
Figure 14	Solar Farm A inverter terminal voltage	34
Figure 15	Solar Farm A inverter terminal output current	34
Figure 16	Solar Farm A POC voltage	34
Figure 17	Solar Farm A POC active and reactive power	35
Figure 18	Solar Farm B POC voltage	35
Figure 19	Solar Farm B POC active and reactive power	35
Figure 20	Solar Farm A inverter terminal voltage	36
Figure 21	Solar Farm A inverter terminal output current	36
Figure 22	Solar Farm A and B POC voltage	36
Figure 23	Solar Farm A POC active and reactive power	37
Figure 24	System under study	37
Figure 25	Solar Farm A and B POC voltage	37
Figure 26	Solar Farm A and B POC active and reactive power	38
Figure 27	Active power	39
Figure 28	Voltage at point of connection	40
Figure 29	Active power	40
Figure 30	Voltage at point of connection	40
Figure 31	Active power	41
Figure 32	Voltage at point of connection	41
Figure 33	Active power	43
Figure 34	Voltage at point of connection	43
Figure 35	Active power	43
Figure 36	Voltage at point of connection	44
Figure 37	Active power	44
Figure 38	Voltage at point of connection	44
Figure 39	Active power	45
Figure 40	Voltage at point of connection	45
Figure 41	Active power	45
Figure 42	Voltage at point of connection	46

## 1. INTRODUCTION

### 1.1 Purpose

These are the *system strength impact assessment guidelines (Guidelines)* made under clause 4.6.6 of National Electricity Rules (NER).

These Guidelines have effect only for the purposes set out in the NER. The NER and the *National Electricity Law* prevail over these Guidelines to the extent of any inconsistency.

### 1.2 Definitions and interpretation

#### 1.2.1 Glossary

The words, phrases, and abbreviations in Table 1 have the meanings set out opposite them when used in these Guidelines.

Terms defined in the *National Electricity Law* and the NER have the same meanings in these Guidelines unless otherwise specified in this Section 1.2.1. Terms defined in the NER are intended to be identified in these Guidelines by italicising them, but failure to italicise a defined term does not affect its meaning.

**Table 1 Glossary of terms and abbreviations**

Term	Definition
4.6.6 Connection	A proposed new <i>connection</i> of a <i>generating system</i> or <i>market network service facility</i> , or an alteration to a <i>generating system</i> to which clause 5.3.9 of the NER applies.
AC	Alternating current
Applicant	A <i>Generator</i> or <i>Market Network Service Provider</i> (MNSP), or a person intending to be registered as a <i>Generator</i> or MNSP who is a <i>Connection Applicant</i> under clause 5.3.2 of the NER, or a <i>Generator</i> making a request under clause 5.3.9.
AG	<i>Asynchronous generating unit(s)</i>
Available Fault Level	The actual <i>synchronous</i> three phase fault level minus the required <i>synchronous</i> three phase fault level specified by an AG manufacturer.
CIGRE TB 671	CIGRE Technical Brochure TB 671 entitled "Connection of Wind Farms to Weak AC Networks"
<u>Committed</u>	<p><u>In respect of an Applicant's proposed connection:</u></p> <ul style="list-style-type: none"> <li>• <u>AEMO has issued a letter to the connecting NSP under clause 5.3.4A of the NER indicating that AEMO is satisfied that each specified access standard meets the requirements applicable to a negotiated access standard under the NER; and</u></li> <li>• <u>AEMO and the connecting NSP have accepted that a detailed PSCAD™/EMTDC™ model provided by or on behalf of the Applicant representing the Applicant's proposed connection meets the requirements of the Power System Model Guidelines.</u></li> </ul> <p><u>In respect of another proposed connection:</u></p> <ul style="list-style-type: none"> <li>• <u>AEMO has issued a letter to the connecting NSP under clause 5.3.4A of the NER indicating that AEMO is satisfied that each specified access standard meets the requirements applicable to a negotiated access standard under the NER;</u></li> <li>• <u>AEMO and the connecting NSP for that other proposed connection have accepted a detailed PSCAD™/EMTDC™ model provided by or on behalf of the Connection Applicant of that proposed connection meets the requirements of the Power System Model Guidelines;</u></li> <li>• <u>any proposed system strength remediation schemes or system strength connection works in respect of that other proposed connection have been agreed between the relevant parties, or determined by a dispute resolution panel; and</u></li> <li>• <u>there is no reasonable basis to conclude that the model previously provided is materially inaccurate, including following commissioning of the connection.</u></li> </ul>
EMT	Electromagnetic transient
EMTDC	Electromagnetic transients including DC
FACTS	Flexible AC <i>transmission system</i>
<u>Fault Level Node</u>	<u>A location on a transmission network at which AEMO determines a fault level should be maintained in its determination of system strength requirements.</u>
Fault Levels Rule	National Electricity Amendment (Managing power system fault levels) Rule 2017 No.10

Term	Definition
Full Assessment	The assessment referred to in clause 4.6.6(b)(2) of the NER.
HVDC	High <i>voltage</i> direct current
Mitigation Measure	Either or both of the following (as the context requires): <ul style="list-style-type: none"> <li>• <i>system strength connection works</i></li> <li>• <i>system strength remediation scheme</i></li> </ul>
MNSP	<i>Market Network Service Provider</i>
NER	National Electricity Rules
NSP	<i>Network Service Provider</i>
Preliminary Assessment	The assessment referred to in clause 4.6.6(b)(1) of the NER.
PSCAD	Power System Computer Aided Simulation
PSS/E	Power System Simulator for Engineering
PV	Photovoltaic
RIT-T	<i>Regulatory investment test for transmission</i>
RMS	Root mean square
RoCoF	Rate of change of <i>frequency</i>
SCR	Short circuit ratio. <del>In the context of AG, SCR is the</del> <i>The synchronous three phase fault level in MVA at the connection point divided by the rated output of the generating unit or generating system (expressed in MW or MVA, at the connecting NSPs' discretion) (as applicable).</i>
STATCOM	Static synchronous compensator
SVC	<i>Static var compensator</i>
Synchronous three phase fault level	<del>The synchronous three phase fault level comprising synchronous machines only, in MVA, calculated for a network with only synchronous generating plant connected. Synchronous generating plant transient impedances are to be used for these calculations.</del>
TNSP	<i>Transmission Network Service Provider</i>

## 1.2.2 Interpretation

~~The following principles of interpretation apply to these Guidelines unless otherwise expressly indicated:~~

These Guidelines are subject to the principles of interpretation set out in Schedule 2 of the *National Electricity Law*.

~~(-) — References to time are references to Australian Eastern Standard Time.~~

## 4.41.3 Related documents

**Table 2 Related documents and links**

Reference	Title	Location
	Power System Model Guidelines <sup>1</sup>	<a href="https://www.aemo.com.au/Stakeholder-Consultation/Consultations">https://www.aemo.com.au/Stakeholder-Consultation/Consultations</a>
PSSG-02	Power System Stability Guidelines	<a href="https://www.aemo.com.au/media/Files/Other/planning/0220_0005.pdf">https://www.aemo.com.au/media/Files/Other/planning/0220_0005.pdf</a>

## 4.51.4 Context

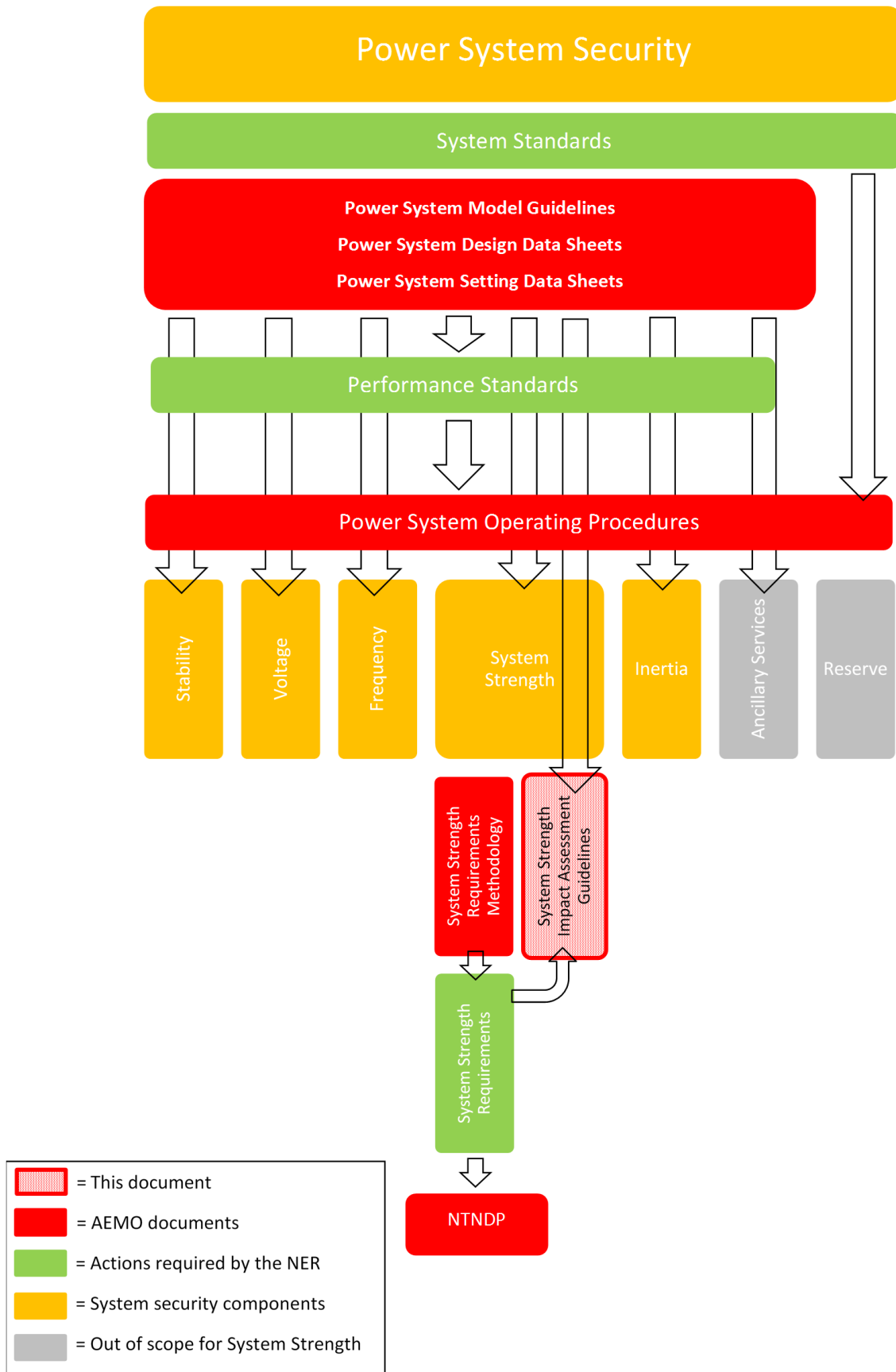
These Guidelines facilitate the assessment of the impact of proposed new and modified *connections* to the *national grid* on system strength.

Figure 1 shows the interrelationship between these Guidelines and other NER instruments and AEMO guidelines, operating procedures and activities. By no means a complete depiction, it highlights the criticality of compliance by NSPs with these Guidelines to be able to maintain system strength.

<sup>1</sup> Note that there is a consultation on this document being run concurrently with this one.



Figure 1 Interrelationship of System Security Market Framework components



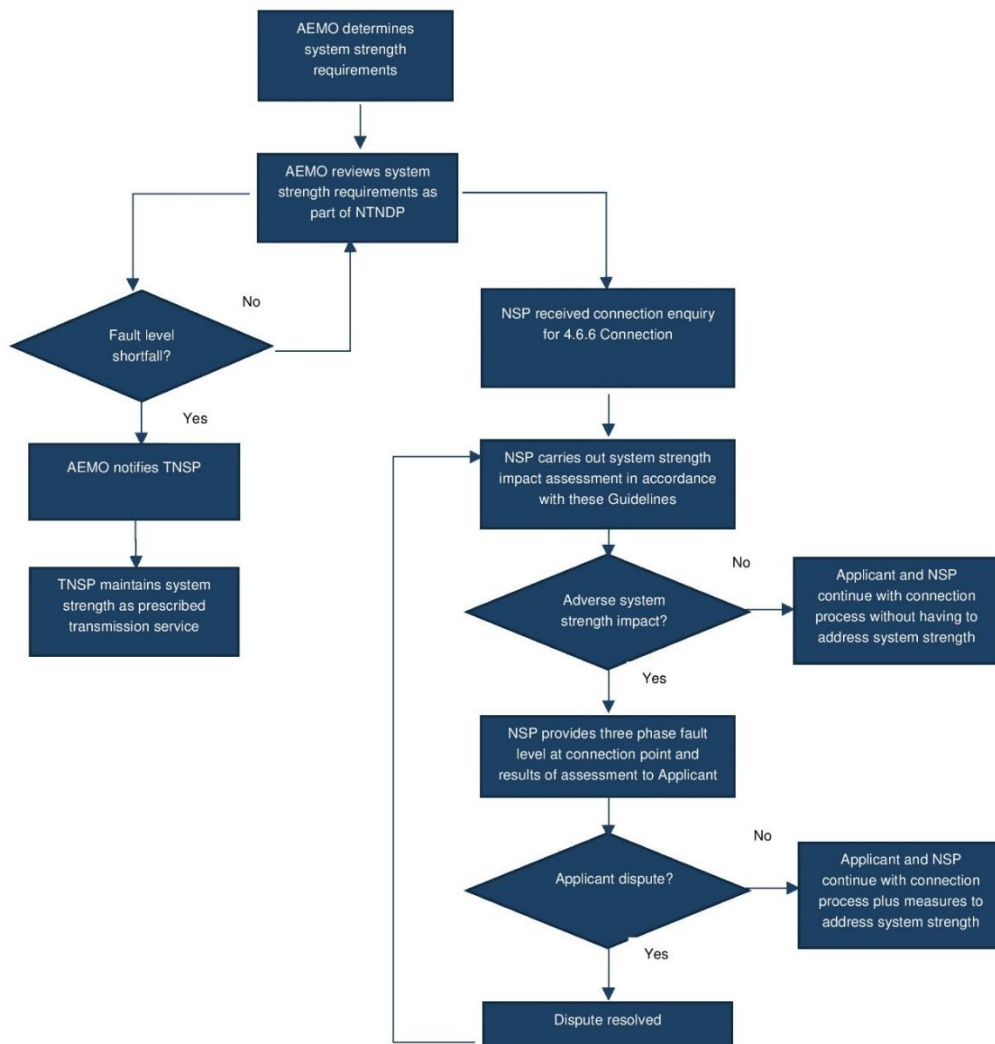
## 2. BACKGROUND

The National Electricity Amendment (Managing power system fault levels) Rule 2017 No.10 (**Fault Levels Rule**) created a framework in the NER for the management of system strength in the *NEM* as follows:

- (a) First, by prescribing a process by which the base level of system strength in each *region*, called the *system strength requirements*, is to be set by reference to the *three phase fault level at fault level nodes* within each *region*.
- (b) Requiring the *Transmission Network Service Providers* (TNSPs) who are also the *System Strength Service Providers* in each *region* to maintain that base level of system strength in each *region*.
- (c) The monitoring of system strength in each *region* and the identification of any *fault level shortfall* as part of the *NTNDP*.
- (d) Prescribing a process by which any *fault level shortfall* is to be addressed by the TNSPs as *prescribed transmission services*.
- (e) Considering how to identify whether certain new *connections* will have an *adverse system strength impact* and how that impact is to be identified and managed.

This framework can be summarised in the flowchart at Figure 2.

**Figure 2 System strength framework in the NER**





## 2.1 AEMO

New obligations on AEMO include the following:

- (a) in consultation with NSPs, determining the fault levels at all *busbars* of the *power system* and the *three phase fault level at fault level nodes* for normal operation and in anticipation of all *credible contingency events* and *protected events* that may affect the configuration of the *power system*<sup>2</sup>;
- (b) determining a *system strength requirements methodology* to be used by AEMO for determining the *system strength requirements* for each *region* as part of the *NTNDP*<sup>3</sup>;
- (c) determining the system strength requirements for each region by reference to the three phase fault level at each fault level node in a region<sup>4</sup>;
- (d) determining whether any *fault level shortfall* exists and notifying the relevant TNSP appropriately requiring the provision of *system strength services* to address that *fault level shortfall*<sup>5</sup>; and
- (e) *publishing* these Guidelines to assist NSPs in determining whether certain new *connections* to their *network* will result in an *adverse system strength impact*<sup>6</sup>.

## 2.2 TNSPs

New obligations on TNSPs who are also *System Strength Service Providers* include the following:

- (a) responding to a *fault level shortfall* identified in an *NTNDP* by procuring and then making available to AEMO *system strength services* to assist AEMO in maintaining the *power system* in a *secure operating state*<sup>7</sup>;
- (b) reporting in its *Transmission Annual Planning Report* about the activities it has undertaken to make *system strength services* available<sup>8</sup>; and
- (c) advising AEMO of any changes to the availability and priority of each of the *system strength services* made available to AEMO<sup>9</sup>.

## 2.3 NSPs

New obligations on NSPs include the following:

- (a) Advising Applicants of the minimum *three phase fault level* at the proposed *connection point* and the results of its Preliminary Assessment when responding to a *connection* enquiry in respect of a 4.6.6 Connection<sup>10</sup>.
- (b) Undertaking *system strength impact assessments* to determine whether a new *connection* to their *network* will result in an *adverse system strength impact* in accordance with these Guidelines<sup>11</sup>.
- (c) Consulting with AEMO before providing the results of the Preliminary Assessment and the Full Assessment to the Connection Applicant<sup>12</sup>.

<sup>2</sup> See clause 4.6.1 of the NER.

<sup>3</sup> See clauses 5.20.1(a)(3) of the NER &

<sup>4</sup> See clause 5.20C.1 of the NER

<sup>5</sup> See clause 5.20C.2(c) of the NER.

<sup>6</sup> See clause 4.6.6 of the NER.

<sup>7</sup> See clauses 5.20C.3 and 5.20C.4 of the NER.

<sup>8</sup> See clause 5.20C.3(f) of the NER.

<sup>9</sup> See clause 4.9.9D of the NER

<sup>10</sup> See clause 5.3.3(b5) of the NER.

<sup>11</sup> See clause 5.3.4B of the NER.

<sup>12</sup> See clause 5.3.4B(b) of the NER.

## 2.4 Applicants

### 2.4.1 Provision of EMT Models for Full Assessment

Appropriate site-specific, vendor-specific detailed *power system* simulation models must have been submitted to AEMO and the NSP undertaking a Full Assessment before it can commence.

Where an Applicant has previously provided adequate RMS models and associated information to AEMO, they will be required to provide up-to-date EMT models if required by the NSP undertaking a Full Assessment as these are the only types of models that will result in an accurate assessment. When such a model is not readily available, the NSP will not commence the Full Assessment until the Applicant provides the required updated model.

More detailed information on modelling requirements for the purposes of carrying out a Full Assessment are in the *Power System Model Guidelines*.<sup>13</sup>

### 2.4.2 Remediation

New obligations on Applicants include the following:

- (a) Paying for system strength connection works undertaken by an NSP to address an adverse system strength impact caused by their proposed connection to the NSP's network or propose a system strength remediation scheme<sup>14</sup>.
- (b) Implementing any agreed *system strength remediation scheme* and providing evidence to AEMO or the connecting NSP upon request that the facilities installed by the Applicant to do so satisfied the requirements of the *system strength remediation scheme*<sup>15</sup>.

## 2.5 Relationship with other processes and documents

### 2.5.1 Power System Stability Guidelines

The Power System Stability Guidelines<sup>16</sup> provide guidance for NSPs and other *Network Users* on how to determine *network* limits associated with a range of *power system* stability phenomena. The document provides guidance on appropriate system models, operating conditions, and assessment criteria that should be applied when undertaking stability assessments.

There has been a growing realisation, both locally and internationally, that traditional positive sequence, Root Mean Square (**RMS**)-based modelling practices are, on their own, inadequate to fully examine the range of new stability issues introduced by the *connection* of large-scale, power electronic based *asynchronous generating systems*.

This is especially true for low system strength conditions where the aggregate short circuit ratio (**SCR**)<sup>17</sup> falls below 3. Guidance on calculation of aggregate SCR is presented in CIGRE Technical Brochure 671: "Connection of wind farms to weak AC networks" (**CIGRE TB 671**)<sup>18</sup>.

### 2.5.2 Power System Model Guidelines<sup>19</sup>

The completion of a Full Assessment depends on the submission of detailed EMT-type models of new or modified *connections*, and of electrically close existing *plant* and *network facilities*.

The *Power System Model Guidelines* detail AEMO's requirements for data and models from Applicants and facilitate access to the technical information and modelling data necessary to perform the required analysis.

<sup>13</sup> Note the contemporaneous consultation being carried out on the *Power System Model Guidelines*, details of which can be found on AEMO's consultation webpage at: <http://aemo.com.au/Stakeholder-Consultation/Consultations>. It is expected to be finalised contemporaneously with these Guidelines.

<sup>14</sup> See clause 5.3.4B(e) of the NER.

<sup>15</sup> See clause 5.7.3A of the NER.

<sup>16</sup> Made under clause 4.3.4(h) of the NER.

<sup>17</sup> Aggregate SCR takes into account the interaction of equipment as function of AC system strength and electrically close *generating systems*.

<sup>18</sup> Available at: <https://e-cigre.org/publication/671-connection-of-wind-farms-to-weak-ac-networks>.

<sup>19</sup> Note the contemporaneous consultation being carried out on the *Power System Model Guidelines*, details of which can be found on AEMO's consultation webpage at: <http://aemo.com.au/Stakeholder-Consultation/Consultations>.

### 2.5.3 Generator Performance Standards

AEMO initiated a Generator Technical Performance Rule change proposal on 11 August 2017<sup>20</sup>. A draft determination is expected to be published by the AEMC in the first half of 2018.

Enhanced technical capability of new *generating systems* is critical to maintaining *power system* robustness and operability under a broad range of *network* operating scenarios, and will also improve the ability of *networks* to “host” future *asynchronous connections*. Ensuring power electronic based *asynchronous generating systems* operate satisfactorily under low system strength conditions will contribute to an increase in penetration of *asynchronous generation*.

It should be recognised that an improved ability of *generating systems* to support normal, contingency, and emergency operating conditions brings benefits not only to *Generators*, but all *Network Users* including customers.

### 2.5.4 System strength and inertia requirement methodologies

In addition to requiring AEMO to develop *system strength impact assessment guidelines*, the Fault Levels Rule requires AEMO to develop a *system strength requirements methodology* to determine the minimum required fault level at *fault level nodes* in the *transmission network* required to maintain *power system security*.

From 1 July 2018, AEMO will use the *system strength requirements* methodology to assess whether a *fault level shortfall* exists, or is likely to exist in the future. Where a *fault level shortfall* exists, TNSPs will be required to procure *system strength services* to maintain the minimum fault levels. The requirement to maintain minimum fault levels at *fault level nodes* will form a critical assumption when assessing the system strength impact of any new or modified *generation connection*.

Finally, as a result of the National Electricity Amendment (Managing the rate of change of power system frequency) Rule 2017 No. 9, by 30 June 2018, AEMO must develop and publish an *initial inertia requirements methodology* to determine the *minimum threshold level of inertia* for each *inertia sub-network*. This will be updated following the conclusion of the *Rules consultation procedures*.

## 3. ADVERSE SYSTEM STRENGTH IMPACT

### 3.1 Defining adverse system strength impact

#### 3.1.1 NER definition

The NER define *adverse system strength impact* as follows:

An adverse impact, assessed in accordance with the *system strength impact assessment guidelines*, on the ability under different operating conditions of:

- (a) the *power system* to maintain system stability in accordance with clause S5.1a.3; or
- (b) a *generating system* or *market network service facility* forming part of the *power system* to maintain stable operation including following any *credible contingency event* or *protected event*,

so as to maintain the *power system* in a *secure operating state*.

The definition can be broken down into the following elements:

- Under all operating conditions:
  - the *power system* will maintain system stability in accordance with clause S5.1a.3;
  - a *generating system* will maintain stable operation following any *credible contingency event* or *protected event*; and
  - A *market network service facility* will maintain stable operation, including following any *credible contingency event* or *protected event*.

<sup>20</sup> Available at: <http://www.aemc.gov.au/Rule-Changes/Generator-technical-performance-standards>.

- Regardless of the *facility* the definition is directed at, an *adverse system strength impact* will not occur if the 4.6.6 Connection does not adversely impact the operation of the *power system* in a *secure operating state*.

### 3.1.2 Power system stability

Clause S5.1a.3 [of the NER](#) requires the *power system* to remain in *synchronism* and be stable in terms of its transient stability, oscillatory stability, and voltage stability. It also provides guidance on the circumstances in which this stability should be maintained, including following *credible contingency events*<sup>21</sup> and *protected events* and the halving times for oscillations.

Traditionally, system stability adverse impacts are caused by large disturbances associated with contingencies, but a *power system* stability adverse impact can also occur due to small disturbances. Additionally, instabilities could arise without any disturbance as, for example, caused by the adverse interaction of *control systems* associated with *generating systems* and *network elements*. These types of stability are often referred to as ‘control system stability’ and it is referred to in AEMO’s Power System Stability Guidelines to describe a situation where, for example, harmonic interactions due to the generation of integer or non-integer harmonics by the control systems can cause an adverse interaction of multiple power electronic *connected plant* leading to possible *disconnection* of the *plant*.

Adverse power quality interactions and *control system* instabilities caused by [proposed](#) 4.6.6 Connections can cause an NSP to breach clause S5.1a.3 [of the NER](#). For this reason, when assessing a [proposed](#) 4.6.6 Connection the NSP should also consider whether it would give rise to instabilities other than those caused by contingencies, including those solely due to a *control system* stability adverse impact.

### 3.1.3 Generating system stability

The stable operation of a *generating system* is determined by reference to whether it can meet its *performance standards* at any level of megawatt (MW) output.

### 3.1.4 Market network service facility stability

The stable operation of a *market network service facility* is determined by reference to whether it can meet its *performance standards*.

## 3.2 Identifying an adverse system strength impact

System strength is measured by reference to the available *synchronous three phase fault level* at a *fault level node* in a *transmission network* [and assuming that the power system will operate to N-1 security limits](#).

[The An](#) NSP must consider whether the following outcomes are likely to occur as a consequence of the 4.6.6 Connection<sup>22</sup>:

- (a) the inability of existing *generating systems* to meet any aspect of their *performance standards*, at any level of MW output of the [proposed](#) 4.6.6 Connection;
- (b) an inability of the [proposed](#) 4.6.6 Connection to meet its proposed *performance standards* (at all levels of MW output and following *contingency events*), for *network* conditions where the *three phase fault level* continues to be maintained at each *fault level node*;
- (c) stability in any *network* cannot be maintained in accordance with the parameters specified in clause S5.1a.3;<sup>23</sup> or
- (d) a reduction in any *transmission network’s* ability to supply *load* within a *region* that cannot be fully restored by reducing the MW output of the [proposed](#) 4.6.6 Connection to zero, while all *generating units* within the [proposed](#) 4.6.6 Connection remain *connected* to the *power system*.

<sup>21</sup> Noting the expanded definition of *credible contingency events* for the purposes of this provision.

<sup>22</sup> See clause 4.6.6(b)(5) & (6) of the NER.

<sup>23</sup> NSPs should keep in mind that one of the implications of the definition of *adverse system strength impact* is that an assessment should not be limited to the impacts on their own *network*. Consideration must be given to outcomes on the *power system* as a whole.

Any one or more of these outcomes will mean that an *adverse system strength impact* will occur as a result of the ~~proposed~~ 4.6.6 Connection.

There is no materiality threshold for the purposes of clause 4.6.6(b)(7) of the NER.

### 3.3 Identifying Committed Projects

#### 3.3.1 Provision of Database

AEMO will provide a secure database to NSPs to enable them to advise each other of the identity of each Committed *generation or market network service facility project* within their *network*. The database will be accessible through the secure AEMO website available only to NSPs.

#### 3.3.2 Updates to Database

Each NSP is responsible for the content of the database in respect of projects within its own network.

Information about new Committed *generation or market network service facility projects* or updates to existing Committed *generation or market network service facility projects* must be entered into the database within 48 hours of the project's becoming Committed or the relevant update, including any decision to de-Commit.

## 4. SYSTEM STRENGTH IMPACT ASSESSMENT PROCESS

The key factors to be assessed are the impact of a ~~proposed~~ 4.6.6 Connection on the stability of the *power system*, on the stability of other *generating systems*, and on the ability of *generating systems or market network service facilities* to continue to meet their *performance standards* under system normal *network* conditions, considering the occurrence of *credible contingency events*, or *protected events*.

NSPs must take into account the following when undertaking the assessments required by these Guidelines:

- (a) all existing *networks, generating units* and other *plant* in close electrical proximity to the ~~proposed~~ 4.6.6 Connection;
- (b) all ~~proposed~~ Committed projects for new generating units, ~~or~~ generating systems or ~~proposed~~ market network service facilities ~~where an application to connect<sup>24</sup> has been submitted~~; and
- (c) all proposed *network facilities* or proposed retirements of *network facilities* if the consultation period of the project assessment conclusion report during the RIT-T for the proposal has concluded.<sup>25</sup>

Clause 4.6.6(b)(1) of the NER requires these Guidelines to specify a two-stage assessment process:

1. A Preliminary Assessment.
2. A Full Assessment.

As required by clause 4.6.6(b)(3) of the NER, the impact on any *protection system* for a *transmission network* or *distribution network* is to be excluded.

### 4.1 Preliminary Assessment

#### 4.1.1 Overview

The objective of a Preliminary Assessment is to identify, through a relatively simple metric, the likelihood of an *adverse system strength impact* caused by the 4.6.6 Connection.

A Preliminary Assessment must be undertaken by an NSP in order to respond to an Applicant's *connection* enquiry under clause 5.3.3 of the NER or a request by a *Generator* under clause 5.3.9(c1)<sup>26</sup>.

<sup>24</sup> ~~Connection Applicants are expected to have submitted proposed performance standards and a site-specific, vendor-specific EMT model with their application to connect.~~

<sup>25</sup> See clause 5.16.4 of the NER.

<sup>26</sup> See clause 5.3.4B(a)(1) of the NER.



It assesses the potential for *adverse system strength impacts* based on the size of the [proposed 4.6.6 Connection](#) relative to the Available Fault Level at the proposed *connection point*, the electrical proximity of other *generating systems/generating units* or *market network service facilities*, and the [minimum SCR](#) withstand capability of the [proposed 4.6.6 Connection](#).

#### 4.1.2 Impact assessment

##### Overview

A Preliminary Assessment is an initial screening using simple, readily derived indices to assess the likelihood of an *adverse system strength impact*. It balances the need for meaningful insight against the time and cost burden of undertaking more rigorous analysis.

At this stage of the *connection/alteration* process, it is unlikely that detailed design information would be available for the [proposed 4.6.6 Connection](#), so detailed simulation models are unlikely to be available.

The Preliminary Assessment will therefore be based on steady state analysis, using a limited subset of *power system* modelling data.

##### Methodology

Several methods have been developed by industry bodies to investigate the impact of multiple electrically close power electronic interfaced *generating systems*. Examples of calculation methods and screening indices suitable for use by NSPs when undertaking a Preliminary Assessment are presented in CIGRE TB 671.

These calculation methods can be classified into Available Fault Level, and various SCR calculation methods. All methods ultimately rely on RMS fault current calculation techniques that can be undertaken using standard load flow/fault level analysis software packages, and are therefore steady state in nature.

*Adverse system strength impact* may be caused by the aggregation of multiple electrically close *asynchronous generating systems*. Where multiple *asynchronous generating systems* are [connected in close proximity near each other](#), a screening index that can account for nearby *asynchronous generation* is required.

The choice of method will also be determined by available *network* modelling information, including the proximity and capacity of *connection points* harbouring significant *embedded generation*.

~~An Applicant should obtain clarification from~~ [Prior to undertaking a Preliminary Assessment](#), the NSP ~~must notify the Applicant of as to what the~~ method ~~the NSP will has been~~ used by the NSP for the Preliminary Assessment, ~~and details of how the method is to be implemented.~~

While the screening methods differ in approach, the premise of each is the same:

- (a) The minimum aggregate SCR<sup>27</sup>/Available Fault Level after *connection* of the [proposed 4.6.6 Connection](#) is compared against the minimum SCR/fault level for which it is capable of **stably operating at stable operation**.
- (b) The headroom (or margin) between the two values (*network capability* versus the 4.6.6 Connection's requirements) provides an initial indication of *connection point* capability to host the [proposed 4.6.6 Connection](#), and therefore the likelihood of an *adverse system strength impact*.

Fault level calculations should consider an intact *network*, with the minimum number of *synchronous* machines online. Careful consideration should be given to which *network elements* provide the greatest support to system strength in the area of interest, and thus need to be considered as critical contingencies.

The analysis should include existing and [Committed projects for new generating systems/generating units](#) or *market network service facilities* in close electrical proximity to the 4.6.6 Connection under assessment.

<sup>27</sup> The term "aggregate" SCR covers all three methods discussed in CIGRE TB 671 for aggregating the impact of multiple electrically close *asynchronous generating systems*. These include composite SCR (CSCR), equivalent SCR (ESCR), Minimum SCR (MSCR) and weighted SCR (WSCR) methods.



Power system simulation studies carried out with detailed simulation models from a number of wind turbine and solar inverter manufacturers demonstrate that the use of a minimum SCR of 3 at the *connection point* is appropriate as a screening threshold. These results are shown in Appendix B. This is consistent with the recommendations made in CIGRE TB 671, however, due to a lack of sufficient data and models used during the Preliminary Assessment, AEMO considers that the NSP should interpret its SCR outcomes conservatively and deduct 10%; for example, a SCR outcome of 3 should be interpreted as 3 minus 10%, or 2.7, which will necessitate a Full Assessment, giving both all parties more confidence in the outcome.

Further, the results in Appendix B show that if the  $SCR > 3$ , the X/R ratio generally has a greatly reduced effect on the performance of the ~~proposed~~ 4.6.6 Connection<sup>28</sup>. Therefore, the use of the X/R ratio as a secondary screening threshold is not required for the Preliminary Assessment.

No further screening index is required to assess the risk of power quality induced stability adverse impact. This is because while the use of simplified approaches is possible, the robustness of such methods cannot be generalised and results may be inconclusive compared to more detailed assessments using detailed time-domain analysis.

A further consideration is the treatment of FACTS devices in fault level and SCR calculations. Appendix C presents results obtained from detailed simulation models of representative wind turbines and FACTS devices. These studies indicate that FACTS devices, whether within a *generating system* or in the *network*, will not be included in SCR calculation methods. Notwithstanding this, if the change in voltage at the busbar of interest is more than 3% due to FACTS devices, an NSP may require a Full Assessment to identify possible adverse interactions between asynchronous generating systems and FACTS devices.

#### 4.1.3 Consultation with AEMO

NSPs have 20 business days from the submission of a connection enquiry to provide a Connection Applicant with the results of a Preliminary Assessment<sup>29</sup> but this is subject to prior consultation with AEMO under clause 5.3.4A(b) of the NER.

To facilitate meaningful engagement with AEMO on the results of the Preliminary Assessment, NSPs must provide the results of a Preliminary Assessment to AEMO at least 5 business days prior to the date by which they are required to provide them to a Connection Applicant, and AEMO will respond within 3 business days to the NSPs with any concerns.

Any concerns are to be discussed between the NSPs and AEMO in a timely manner to facilitate the NSPs' response to a Connection Applicant in accordance with the NER.

#### 4.1.34.1.4 Results of Preliminary Assessment

The NSP must advise an Applicant of the results of a Preliminary Assessment within 20 business days of receipt of a connection enquiry or submission under clause 5.3.9(c1) of the NER (as applicable).<sup>30</sup>

Where the NSP's conclusion is that:

- (a) an *adverse system strength impact* will exist if the ~~proposed~~ 4.6.6 Connection proceeds; or
- (b) the Preliminary Assessment was inconclusive,<sup>31</sup>

a Full Assessment will be required if an *application to connect* is made under clause 5.3.4 of the NER or a submission is made under clause 5.3.9 of the NER.

#### 4.1.44.1.5 Information to be provided with results of Preliminary Assessment

Where the conclusion of the Preliminary Assessment was that an *adverse system strength impact* will exist if the ~~proposed~~ 4.6.6 Connection Proceeds or that it was inconclusive, NSPs must provide Applicants with the following information:

<sup>28</sup> Refer Appendix B for details.

<sup>29</sup> See clause 5.3.3(b4) of the NER.

<sup>30</sup> This is consistent with the requirement under clause 5.3.3(b4) of the NER.

<sup>31</sup> An inconclusive outcome is likely to be the result of a lack of sufficient data, so Applicants need to be aware that an *adverse system strength impact* could result from a Full Assessment in those circumstances.

- (a) details of the studies undertaken by the NSP;
- (b) details of the assumptions made by the NSP as to current and future *generation* patterns, *network* configurations, *augmentations*, and retirement of *network plant*;
- (c) the level of modelling detail required for a Full Assessment, particularly of the surrounding *network* and nearby *generating systems* or *market network service facilities* either already *connected* or to be assessed in parallel;
- (d) an indication of the adequacy of the 4.6.6 Connection's capability under the prevailing system strength conditions; and
- (e) the scope of necessary *power system* studies required for a Full Assessment.

## 4.2 Full Assessment

Unless the Preliminary Assessment indicates that a Full Assessment is not needed, a Full Assessment must be undertaken by an NSP upon receipt of an *application to connect* under clause 5.3.4 of the NER or submission from a *Generator* under clause 5.3.9<sup>32</sup>.

This will require assessment of a range of potential impacts under a range of operating conditions to determine whether the *proposed* 4.6.6 Connection will have an *adverse system strength impact*. The range of studies required for a Full Assessment necessitates the use of EMT-type simulation tools<sup>33</sup>.

### 4.2.1 Contingency induced stability impact assessment

#### Overview

The full range of possible interactions between *asynchronous generating systems*, *synchronous generating systems*, and the wider *power system* to which they are *connected* is more complex than those pertaining to *power systems* dominated by *synchronous generating systems*.

Highly detailed studies are necessary to determine the overall *power system* response and potential *adverse system strength impact* when accounting for the interaction between multiple *generating systems* and surrounding *network elements*.

This analysis will require an appropriate, project-specific EMT-type simulation model of the entire *proposed* 4.6.6 Connection. It will also require suitable models of the nearby *network* and *generating systems* in the same simulation software packages.<sup>34</sup>

The use of more detailed modelling and simulation tools *providesserves* a solid basis to:

- (a) assess whether a *proposed* 4.6.6 Connection can meet its own proposed *performance standards*;
- (b) assess the impact of a *proposed* 4.6.6 Connection on the ability of existing *generating systems* to meet their *performance standards*;
- (c) assess the impact of a new or modified *generation connection* on the ability of other *Committed generating systems* to meet their proposed *performance standards*;
- (d) identify whether the *adverse system strength impact* is caused by the interaction of multiple *generating systems* and *market network services facilities*, rather than by a particular *generating system*; and
- (e) evaluate the impact of proposed Mitigation Measures that could address the *adverse system strength impact*.

EMT-type simulation tools have been increasingly used by equipment manufacturers for designing and tuning wind turbines and solar inverters' *control systems* for *connection* of wind and solar farms in areas of the *NEM* with low system strength.

<sup>32</sup> See clause 5.3.4B(a)(2) of the NER. Note that the *application to connect* must be complete and accompanied by proposed *performance standards* and a compliant EMT model of the *proposed* 4.6.6 Connection.

<sup>33</sup> See clause 4.6.6(b)(2) of the NER.

<sup>34</sup> See also *Power System Model Guidelines*.

PSCAD™/EMTDC™ is widely used by major *power system* equipment manufacturers covering equipment such as wind turbines, solar inverters, and High Voltage Direct Current (HVDC) and Flexible AC Transmission System (FACTS) devices.

Detailed *power system* modelling and simulation with an EMT-type tool (PSCAD™/EMTDC™ tool is used by AEMO and NSPs) will be necessary for performance assessment studies where the capability of a proposed 4.6.6 Connection is not sufficiently above the minimum calculated aggregate SCR/Available Fault Level determined following the Preliminary Assessment. For example, with the use of aggregate SCR as the screening index, CIGRE TB 671 suggests that the use of an aggregate SCR of 3 at the *connection point* as the threshold below which EMT-type modelling is necessary, which is consistent with requiring a Full Assessment where the SCR threshold of  $< 3$ .

This is because the dynamics associated with very fast acting *control systems* in *asynchronous plant* can have a dominant impact in determining the overall *plant* response. This is particularly true as system strength declines. Such fast acting *control systems* cannot be accounted for in RMS-type simulation tools, such as PSS®E. Therefore, the use of an RMS-type simulation tool will not allow adequate investigation of operating conditions resulting in potential *power system* instability due to the lack of system strength, or adverse interaction between multiple electrically close *generating systems* and *market network service facilities*.

### Methodology

The Full Assessment may be conducted in two stages:

- (a) The first stage will be carried out using a detailed EMT-type model of the proposed 4.6.6 Connection, and can be based on the proposed 4.6.6 Connection operating against an equivalent lumped *network* model with progressively reduced system strength.

This will indicate the margin between expected *network* conditions and conditions where the simulation model becomes unstable, under conditions of no *network* disturbance and following any *credible contingency event* or *protected event*. Such an assessment will also help indicate the capacity of the nearby *network* to host further *generation* in future, and can be used as a validation of the Preliminary Assessment.

Hybrid modelling techniques could be adopted to achieve this. Detailed EMT-type modelling could be undertaken for the *plant* under consideration, while *plant* models in remote locations with respect to the *plant* under consideration can be represented in an RMS-type simulation tool such as PSS®E. This approach provides ease of access to RMS-type models, however, requires third-party modules to make the interface between the RMS- and EMT-type tools. This approach is primarily suitable for conducting *system strength impact assessment* for remote and isolated *connections*.

- (b) A second stage is needed, where there are multiple electrically close *generating systems* and other *plant* that can equally impact system dynamics. In such cases, there is a need for an EMT-type model of a larger portion of the *power system* that could reasonably impact the response of the 4.6.6 Connection under consideration. The required portion of the *power system* for EMT-type modelling will be considered by the relevant NSP on a case-by-case basis.

The *power system* model chosen for the analysis should include detailed vendor-specific EMT-type models of all nearby *generating systems* and other *plant* that could reasonably impact the dynamic performance of the proposed 4.6.6 Connection under consideration. These models should include adequate representation of all relevant *control systems* and *protection systems*.

Following completion of these studies, the scenarios set out in Section 4.3 should be applied to determine whether an *adverse system strength impact* will occur, and which *plant* is involved.

## 4.2.2 Control system induced stability impact assessment

### Overview

Power quality studies are generally conducted by a *Connection Applicant* submitting an *application to connect* a proposed *generating system* for consideration by the relevant NSP. These studies do not often encompass potential adverse *control system* interaction of multiple electrically close *generating systems* and dynamic reactive support *plant* due to the inferior quality of voltage and current waveforms

in low system strength conditions. The methodology discussed below is not aimed at replacing or replicating conventional power quality studies conducted by the *Connection Applicant*, but to allow the relevant NSP to identify power quality issues that can manifest themselves into system stability concerns and an *adverse system strength impact*. Similar to contingency induced stability impact assessments, these studies are conducted by the NSP undertaking *adverse system strength impact assessment*.

## Methodology

The Full Assessment must be conducted in two stages:

### Stage 1: Estimation of harmonic distortion

#### 1a - Harmonic impedance scan studies

This assessment is designed to identify power quality issues, e.g. excessive harmonic injection or coincidence of a harmonic frequency with a network resonance point, that could manifest themselves into system stability concerns.

Prior to a ~~proposed~~ 4.6.6 Connection, the NSP computes the system harmonic impedances at the proposed *connection point*. A wide range of system operating conditions should be examined to include variations caused by *outages* of single lines and *transformers*, plus numerous combinations of in-service shunt capacitor banks.

At each harmonic:

- these impedances are plotted on a resistance-reactance (R-X) plane;
- the harmonic impedances with magnitudes that are exceeded for 5% of calculated values excluded; and
- A polygon (usually with ten vertices) that encloses all the remaining R-X values is defined.

These studies must:

- include all components of a ~~proposed~~ 4.6.6 Connection including the collector cables and *transformers*;
- assess several system-impedance R-X points that lie along the boundary of the system-impedance polygon as determined by the above *network* scan studies, rather than just the R-X points that define the vertices of the polygon. There is no requirement to assess system-impedance R-X points that lie within the polygons;
- consider the *outages* of individual collector feeders within the *generating system*; and
- account for tolerances on the design values of the *generating system's* balance of *plant* components, such as *transformer* series impedances and cable lengths.

#### 1b - Modelling conducted by the Applicant of the ~~proposed~~ 4.6.6 Connection

The ~~proposed~~ 4.6.6 Connection is responsible for defining the magnitudes of the harmonic source currents for individual *generating units*. The origin of these harmonic source currents<sup>35</sup> needs to be documented.

The method applied to summate the effects of several individual harmonic sources in an *asynchronous generating system* comprising several individual *generating units* must be justified<sup>36</sup>.

#### 1c - Harmonic voltage calculations

The NSP undertaking the *system strength impact assessment* must calculate the harmonic voltages accounting for the impact of multiple electrically close *generating systems* and

<sup>35</sup> As an example tests defined in IEC 641400-21 for wind turbines

<sup>36</sup> In general, multiple harmonic-current sources in an *asynchronous generating system* will have in-phase characteristics as, for example, discussed in CIGRE TB 672<sup>36</sup> for solar inverters. This infers that in assessing harmonic-voltage contributions from solar inverters to be connected to a *network*, the harmonic source currents from all individual *generating units* can be considered in phase for all harmonic orders. If the proposal from a 4.6.6 Connection is to apply a harmonic summation method that (at a particular harmonic) considers the harmonic source currents are not in phase, provision of measured harmonic currents substantiating the use of the alternative method is necessary.

dynamic reactive support *plant*. Connection of passive components (i.e. *transformers* and cables) of a [proposed](#) 4.6.6 Connection can produce amplification of existing harmonics due to excitation of a harmonic resonance frequency<sup>37</sup>. Depending on the level of calculated harmonic voltages, and the position of individual harmonic impedances within the R-X plane, the NSP undertaking *system strength impact assessment* may advise the Applicant of the need for proceeding with second stage based on detailed time-domain analysis as discussed below.

## Stage 2: Harmonic interaction and susceptibility studies

A [proposed](#) 4.6.6 Connection<sup>38</sup> must operate satisfactorily in the presence of a specified level of power quality (as determined by the NSP) at the *connection point* where power quality constitutes of harmonics, flicker and unbalance. The level of susceptibility of inverter controls to power quality may vary depending on the system strength.

The NSP undertaking the *system strength impact assessment* needs to demonstrate that *connection* of multiple electrically close *generating systems* and dynamic reactive power support *plant* does not cause interaction issues that may, in turn, manifest themselves into system stability issues without a contingency being applied.

Similar to contingency-induced stability assessments, this analysis requires an appropriate, project-specific EMT-type simulation model of the [proposed](#) 4.6.6 Connection with additional modelling details, in particular for harmonic interaction and susceptibility analysis as set out in the *Power System Model Guidelines*. These studies will also require suitable models for the *connecting network* implemented in the same EMT-type simulation software package.<sup>39</sup>

### 4.2.3 Consultation with AEMO

[NSPs must consult with AEMO under clause 5.3.4A\(b\) of the NER on the results of a Full Assessment before providing them to an Applicant.](#)

[To facilitate meaningful engagement with AEMO on the results of a Full Assessment, NSPs must not provide the results to AEMO at least until after the AEMO has advised on AEMO advisory matters. Consistent with the requirement to respond to a proposed system strength remediation scheme,<sup>40</sup> AEMO will respond within 20 business days to the NSPs with any concerns over those results.](#)

[Any concerns are to be discussed between the NSPs and AEMO in a timely manner to facilitate the timely provision of an offer to connect.](#)

### 4.2.4 Results of Full Assessment and Information to be provided with Results

[NSPs must advise Applicants of the results of a Full Assessment and provide them the following information:](#)

- [\(a\) details of the studies undertaken by the NSP;](#)
- [\(b\) details of the assumptions made by the NSP as to current and future generation patterns, network configurations, augmentations, and retirement of network plant;](#)
- [\(c\) the level of modelling detail assessed, particularly of the surrounding network and nearby generating systems or market network service facilities either already connected or to be assessed in parallel; and](#)
- [\(d\) an indication of the adequacy of the 4.6.6 Connection's capability under the prevailing system strength conditions.](#)

### 4.2.34.2.5 Sole or Multiple Full Assessments

If a Full Assessment of a [proposed](#) 4.6.6 Connection is impacted by one or more other [proposed](#) 4.6.6 Connections that are electrically close to each other, the NSP may carry out one Full Assessment for all of them if the Applicants have agreed to share the costs of any proposed Mitigation Measures. The

<sup>37</sup> R P D Ross, M P De Carli, P F Ribeiro, "Harmonic distortion assessment related to the connection of wind parks to the Brazilian transmission grid", CIGRE Paper C4- 101, 2016 Paris Session.

<sup>38</sup> As required by clause S5.2.5.6 of the NER in the case of *generation*, and by the *connection agreement* in the case of a *market network service*.

<sup>39</sup> See also [the Power System Model Guidelines](#).

<sup>40</sup> See [clause 5.3.4B\(j\) of the NER](#).



NSPs will need to resolve, directly with the affected Applicants, any issues over the use and sharing of *confidential information* for the purposes of the Full Assessment.

### 4.3 Scenario selection

This Section 4.3 outlines key factors that need to be taken into consideration when developing an efficient set of simulation scenarios for the studies carried out as part of a Full Assessment. It also provides guidance about the different *network* conditions, *dispatch* patterns, and other matters to be considered by NSPs when carrying out a Full Assessment<sup>41</sup>.

#### 4.3.1 Generation dispatch profiles

*Synchronous generation commitment* patterns are a key variable affecting system strength, along with the electrical impedance of the *network* between the *proposed* 4.6.6 Connection and major *generation* centres. *Asynchronous generation commitment* patterns have very little impact on system strength.

Low levels of *synchronous generation commitment patterns* are strongly correlated with low system strength. Low *synchronous generation* may or may not coincide with minimum demand conditions, where other factors, such as *interconnector* flows and the amount of online rooftop photovoltaic (**PV**), also come into play. As a result, the minimum demand cases, by themselves, are not the most appropriate predictor of low system strength conditions.

General guidance is provided on the minimum quantity (and combinations if applicable) of *synchronous generation* that should be considered in each modelling zone (which may comprise more than one *region*) when conducting studies to identify *adverse system strength impacts*.

The requirements vary from one *region* to another, as discussed below. These minimum levels of *synchronous generation* should be considered for both the Preliminary Assessments and Full Assessments.

#### Prior to publication of system strength requirements

Until AEMO publishes the inaugural *system strength requirements* in accordance with clause 5.20C.1(a) of the NER on 30 June 2018,<sup>42</sup> NSPs are to be guided by the requirements detailed for each *region* as follows:

#### South Australia

Detailed EMT-type studies have been used to determine the minimum levels and combinations of *synchronous generation* that must be maintained at all times in South Australia, for varying *asynchronous generation dispatch* levels. This is required to maintain the *power system* in a *secure operating state*. Information on minimum *synchronous generation* requirements in South Australia is available on AEMO's website<sup>43</sup>.

#### Tasmania

The potential impact of *proposed* 4.6.6 Connections on future inertia and fault level requirements will inherently form part of the *connection* application assessments undertaken at that time.

For the purposes of a Full Assessment, TasNetworks has identified three minimum requirements:

1. & 2. The minimum fault level requirements at the George Town 220 kV bus and maximum permitted system Rate of change of *frequency* (**RoCoF**) levels, as a function of *generation dispatch*, *load*, and demand contingency size in Tasmania. TasNetworks has determined equations to describe these limits, which AEMO has implemented as *dispatch constraint* equations to maintain *power system security*, that is, that the relevant requirement is met after a critical *credible contingency event*.
3. TasNetworks aims to maintain an aggregate SCR of 3 at the Smithton 110 kV Substation.

<sup>41</sup> See clause 4.6.6(b)(4) of the NER.

<sup>42</sup> See clause 11.101.4(a).

<sup>43</sup> Available at <http://www.aemo.com.au/Electricity/National-Electricity-Market-NEM/Security-and-reliability/Congestion-information/Limits-advice>.



### Other regions

As at time of *publication*, there are no identified minimum *synchronous generation* requirements for Victoria, New South Wales, or Queensland, for varying *asynchronous generation dispatch* levels. The relevant TNSP should be consulted for advice on the minimum acceptable *synchronous generation commitment patterns* when undertaking a Full Assessment.

It should be noted that in some cases *synchronous generation* patterns in these *regions* have changed significantly due to closure of *plant*, increased competition from new entrants, and changing economics of fuel sources. As a result, some long-standing historical assumptions about minimum *generation* levels no longer remain appropriate.

Minimum *generation commitment* patterns must respect technical factors, such as minimum technical unit operating levels, local requirements for *voltage* control, and any other limits to the *technical envelope* that may be identified by a TNSP. Recently observed minimum *synchronous generation dispatch* levels should form a starting point, but might require further reductions for further analysis. As a minimum, NSPs should consider the displacement of *generation* due to *Committed*, but not operational, *generating systems* and credible loss of the remaining *generating unit(s)* providing the most significant system strength infeed.

Where *synchronous generation* local to the [proposed 4.6.6 Connection](#) is vital to local system strength, full *outage* of this *generation* should be considered.

### After publication of System Strength Requirements

From 30 June 2018, the *system strength requirements* published by AEMO in accordance with clause 5.20C.1(a) of the NER<sup>44</sup> will state the minimum *three phase fault level* at each *fault level node* in each *region*.

### 4.3.2 Contingency events

*Contingency events* and *network conditions* for a *system strength impact assessment* are broadly similar to those used historically to assess the impact of a [proposed 4.6.6 Connection](#) on *network stability and performance standards*. In other words, when assessing system strength NSPs should consider those known contingency events (including historical reclassifications) and network conditions.

### Preliminary Assessment

For all screening methods used for the Preliminary Assessment (see Section 4.1), three phase symmetrical faults are applied in a conventional quasi-steady-state fault current calculation engine using *synchronous generation's* *sub-transient* impedance, so no dynamic simulations are involved.

### Full Assessment

Stability should be assessed under system normal conditions, considering the most severe *credible contingency event* and other events set out in proposed *performance standard* (normally a two-phase-to-ground fault at the most onerous location in the *network* that would likely have highest stability impact on the *network*). In a part of the *network* where certain multiple *contingency events* have been or can be temporarily assessed-reclassified as credible contingency events, for example multiple line trips due to lightning, stability for these events should be considered. Local operational policies in relation to protection reclose should also be considered. Analysing these types of events will ensure that appropriate operational measures can be put in place to manage power system security risks, however, system strength connection works or system strength remediation schemes are not generally required to address an adverse impact on the power system caused by these types of events.

### 4.3.3 Protected events

While no *protected events* have been declared yet, future *system strength impact assessments* may require assessment of certain *protected events* to identify the impact of a [proposed 4.6.6 Connection](#) on *power system* performance.

<sup>44</sup> See clause 11.101.4(a).

## 5. MITIGATION MEASURES

If a ~~proposed~~ 4.6.6 Connection is assessed as having an *adverse system strength impact*, Mitigation Measures must be taken. There are two types of Mitigation Measures:

- System strength connection works
- System strength remediation schemes.

Where appropriate, more than one Mitigation Measure can be adopted<sup>45</sup>.

### 5.1 System strength connection works

The following is a non-exhaustive list of potential *system strength connection works* that could be used by an NSP to mitigate any *adverse system strength impact*.

- (a) new *transmission lines* or *transformers* external to the ~~proposed~~ 4.6.6 Connection, potentially remote from its proposed *connection point*;
- (b) upgrades to existing *transmission lines* to operate at a higher *voltage* level;
- (c) the use of lower impedance *transformers* at either the collection grid or *network* interface;
- (d) reconfiguration of existing *networks*, for example, alternative switching arrangements involving 'normally open points' in the *network*, which may require upgrade to primary or secondary equipment;
- (e) installation of new *synchronous condensers*;
- ~~(f) Installation of FACTS devices.~~
- ~~(g)~~(f) installation of active or passive harmonic filters;
- (g) modifications to *control systems* belonging to the NSP or other *Network Users*;<sup>46</sup>
- (h) the use of *asynchronous plant*<sup>47</sup> based on grid forming converter technologies allowing the *plant* to stably operate at an SCR level of down to zero<sup>48</sup>.

NSPs must carry out power system modelling and simulation studies ~~are required~~ to demonstrate ~~that whether~~ proposed *system strength connection works* can mitigate all identified *adverse system strength impacts*.

*Plant* installed by the NSP in the wider *network*, rather than just at the ~~proposed~~ 4.6.6 Connection's *connection point*, can provide additional benefits and may be subject to agreed cost-sharing arrangements between the Applicant and other parties.

### 5.2 System strength remediation schemes

*System strength remediation schemes* may include *plant* behind a *connection point* (that is, part of the ~~proposed~~ 4.6.6 Connection).

The following is a non-exhaustive list of potential *system strength remediation schemes* that could be used by an NSP to mitigate any *adverse system strength impact*.

- (a) reduction in the registered capacity of the *plant*;
- (b) modifications to *control systems* forming part of the ~~proposed~~ 4.6.6 Connection;
- (c) contracting with *Generators* with *synchronous generating systems* for the provision of *system strength services*;
- (d) modification to arrangements at or behind the ~~proposed~~ 4.6.6 Connection's *connection point*, such as:
  - (i) use of a higher *connection voltage*;

<sup>45</sup> See clause 4.6.6(b)(8) of the NER.

<sup>46</sup> Such as other *Generators*, as permitted by clause S5.2.2 of the NER and for MSNPs, as permitted by clause S5.3a.2.

<sup>47</sup> This includes asynchronous generating units and FACTS devices.

<sup>48</sup> This can be in addition to, or as a replacement for asynchronous generating units already considered by the Applicant.

- (ii) use of multiple or lower impedance *transformers*;
  - (iii) use of lower impedance feeder *networks*;
  - (iv) installation of synchronous condensers;
  - (v) installation of active or passive harmonic filters;
  - (vi) installation of local STATCOMs or similar FACTS devices.
- (e) post-contingency control schemes (such as a System Integrity Protection Scheme (SIPS))<sup>49</sup>; or
  - (f) as a last resort, the use of *dispatch constraint* equations.

NSPs must carry out power system modelling and simulation studies ~~are required~~ to demonstrate ~~that whether~~ the application of all proposed *system strength remediation schemes* can mitigate all identified *adverse system strength impacts*.

### Post-contingency control schemes

Post-contingency control schemes have been used successfully in the *NEM*, and have allowed operation of the *power system* beyond traditional N-1 security limits.

Such schemes require careful design and assessment to ensure that their operation does not result in other *adverse network* impacts, such as local *voltage* control issues, or broader *power system* stability or *frequency* control impacts. This is particularly true if the *generation* change caused by the operation of the control scheme is large, relative to either the local *network* capacity or the capacity of the broader *network*.

There is limited experience to date with the use of post-contingency tripping or other control schemes to manage *network* stability issues arising from the *connection* of *generation* under low system strength conditions. The acceptability of any such control scheme will be subject to both the details of the design and the local characteristics of the *network* for which it is proposed.

Any post-contingency control scheme proposal intended to mitigate an *adverse system strength impact* must demonstrate that the scheme results in no wider *power system security* or operability impacts. This will particularly be the case where multiple control schemes may be proposed for a specific area of the *network* subject to low system strength conditions, but offering other favourable characteristics (such as energy resource or land availability).

The potential for negative interactions between post-contingency control schemes must be carefully considered, especially when a common set of *contingency events* can result in multiple schemes operating simultaneously.

Where such negative interactions are likely, a single control scheme may, in isolation, have an acceptable impact on *power system* performance, but multiple similar schemes would not. This may occur due to the cumulative impact of the different schemes, particularly where the triggering event for action of these schemes may be similar, and their action triggers a reduction in output from one or more *generating systems*.

Where a control scheme is proposed as a *system strength remediation scheme*, the following risks may need to be assessed:

- (a) The largest total *generation* or *load* contingency that may occur due to control scheme action.
- (b) Local impacts of such a contingency, particularly on *network voltage* control and thermal loading.
- (c) Broader system impacts of such a contingency, particularly on *frequency* control, including the potential cost of *frequency* control *ancillary services*, and on *power system* stability limits.

Widespread use of such control schemes across a broad *network* area comprising several *generating systems* can introduce significant operational risks. As a result, it is unlikely that such proposals would be accepted as a *system strength remediation scheme* for multiple nearby projects unless significant

<sup>49</sup> See Clause 5.2.5.8(e) of NER

design, simulation, and reporting activity is undertaken to demonstrate the robustness and security of such a proposal.

The veracity of any proposed post-contingency control scheme would not only need to be demonstrated by *power system* modelling and simulation, but also confirmed by end-to-end commissioning tests.

### 5.3 The use of dispatch constraints in the management of system strength

The *central dispatch* process relies on the use of *dispatch constraint* equations to ensure that the *power system* is operated within secure limits when determining economic *dispatch* of *generation*.

*Dispatch constraint* equations are well suited to the management of *network* thermal limits, where marginal adjustment of *generation* output is used to ensure the *network* is operated within thermal ratings. *Dispatch constraint* equations are also used to manage a range of existing *voltage* and transient stability limits, typically by limiting total power flows on *network* cut-sets or across defined interface points.

It is not yet clear, however, whether *dispatch constraint* equations without a [generating unit's](#) *commitment* capability will be an optimal mechanism to manage the potential stability impacts caused by 4.6.6 Connections under low system strength conditions. In particular, *dispatch constraint* equations can only be used to alter or limit the MW output of online *generation*, and cannot directly alter *generation commitment* patterns.

To illustrate this point by way of example, consider an *asynchronous generating system* producing a given MW output at its *connection point*, with either:

- half of the individual generating units operating at a particular level, and the other half disconnected; or
- all generating *units* online and operating, but at half the output level.

While these two different scenarios may result in the same MW output of the *generating system*, the impact on *network* stability can be different because of the difference in the effective size of the *generating system*. Such scenarios can arise where *generation* runback schemes are implemented, but where the number of *generating units* remaining online is not explicitly managed. Such issues need to be carefully considered if *dispatch constraint* equations are proposed to manage an identified *adverse system strength impact*.

Another challenge with the use of *dispatch constraint* equations to manage *adverse system strength impacts* is a requirement to use EMT models to accurately assess system stability under low system strength conditions. Due to the high computational (and resulting time) burden, the use of EMT models limits the ability to run studies over a broad range of operating conditions, which are typically required to develop the most precise, and location-specific, *dispatch constraint* equations.

As a result, if *dispatch constraint* equations are used to manage *power system* stability in conditions of low system strength, more broadly applied *constraint* equations on *generation* may be required. This outcome can blunt, or remove entirely, any locational signals with respect to the system strength impacts of new *generation connections*, and the incentive to identify more optimal locations to *connect*.

For these reasons, the potential use of *dispatch constraint* equations will require careful assessment by both the *connecting* NSP and AEMO. They should only be considered under system normal conditions as a last resort for managing an *adverse system strength impact* if it can be clearly demonstrated that limiting the MW output of a *generating system* will always be an effective mechanism to manage any potential impact arising from its *connection*.

*Dispatch constraint* equations may be a more effective mechanism for managing stability issues that occur only under *network outage* conditions, where they would only be rarely used, and the impact of any conservatism required in their application will be more limited.

## APPENDIX A. PRACTICAL EXAMPLES

### A.1 Defined terms

In addition to the terms defined in Section 1.2.1, Appendix A uses further terms that have the meanings set out opposite them in Table 3. The following assumptions are made:

- For fault level calculations the generating unit terminal voltages are 1 p.u.
- The fault level calculations use the SG sub-transient impedance values ( $X_d''$ ,  $X_q''$ ).
- AG requires a minimum level of synchronous three phase fault level which is equal to the minimum SCR (as advised by the manufacturer) multiplied by the MW rating of the AG.

Note: Fault level calculations made with transient or sub-transient impedances produce somewhat different fault current levels. Sub-transient values will give ~~the a higher estimate of higher~~ fault currents ~~associated with fault inception for faults cleared in primary protection clearance time, whereas the transient impedances give current levels closer to those observed at fault clearance~~. Since the main purpose of this screening methodology is to assess the risk of adverse asynchronous generation interaction, especially during the fault and immediately after the recovery period, using the sub-transient impedance values is most suitable. Also, for the correct assessment of the fault current contribution from AG it is important that AG data reflecting right impedance for the IEC 60909<sup>50</sup> based fault calculation is used. If the right set of data is not fed to the grid model, at various locations, the fault level calculation will not be correct, producing a flawed Preliminary Assessment outcome.

It is inappropriate to use the “steady state” *synchronous generation* impedance values ( $X_d$ ,  $X_q$ ) for SCR calculations, due to the strong influence of the *generating units*’ automatic voltage regulators over these slower time scales. In addition, as the AC system becomes weaker, it is reliable fault ride-through (FRT) performance which will typically degrade before steady state stability, so FRT is the critical design point to assess. However, low system strength conditions can result in a situation where steady state instability occurs first, as discussed in Appendix A.3.

**Table 3 Defined terms**

Term	Definition
AFL	Available Fault Level in MVA
Effective Impedance	This AG impedance is given by $V^2 / (\text{MSCR} * \text{MW rating})$ .
FRT	Fault ride-through
MSCR	Minimum SCR: the lowest SCR that the AG requires to comply with its <i>performance standards</i> .
MVA	Mega volt amperes
SCC	Three phase short circuit capacity
SCR	<del>Short circuit ratio. The Synchronous Three Phase Fault Level at the connection point divided by the MW rating of the AG.</del>
SG	<i>synchronous generation</i>
SMIB	Single machine infinite bus
Synchronous three phase fault level ( $S_{SG}$ )	The <i>three phase fault level</i> , in MVA, calculated for a <i>network with only synchronous generation plant connected</i> .

### A.2 Preliminary Assessment

Most AG is only specified for operation above a minimum SCR at its connection point. This specification is often driven by AG FRT limitations under weak system conditions. The main AG challenges at low SCRs relate to:

- The provision of sufficient fast reactive power support; and
- The maintenance of close *synchronism* with the rapidly changing system phase angle.

<sup>50</sup> IEC Standard 60909-0 Short-circuit currents in three-phase a.c. systems



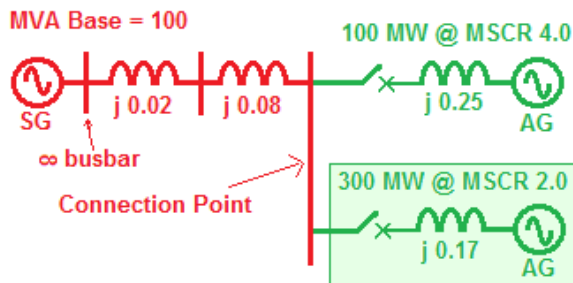
A methodology explained in CIGRE TB 671 is expanded here to show a practical "screening" process for new AG *connections*. The impact of AG beyond its *connection point* is assumed to be proportional to its MW rating multiplied by its minimum SCR (**MSCR**)<sup>51</sup>. Therefore, the AG is represented as a Thévenin *voltage* source *connected* to the *network* behind its Effective Impedance. This representation does not generate the actual AG fault currents but, instead, produces a current related to the impact of the AG on the surrounding AC *network*. This concept is an extension of the calculation method commonly employed where AG shares a common *connection point*.

This assessment process provides a metric to highlight the risk of *adverse system strength impact* and is described by way of two examples. The first example introduces the concept, while the second example is a practical application based on the Tasmanian *power system*.

### A.2.1 Example (1) calculation of available fault level at a local busbar

This example is a simplified demonstration of how to estimate the capability of the *network's connection point* to support a [proposed 4.6.6 Connection, which is an AG connection](#).

**Figure 3 Calculation of local AG impact on connection point capability**



Consider the *connection point* shown in Figure 3 where an existing 100 MW AG is *connected*. A second AG (shaded) wishes to share the *connection point*.

For ease of explanation, the *generation* outputs are all 1 p.u. *voltage* at zero phase angle and circuit resistance is ignored. The following calculation steps are made:

1. Calculate the fault level at *connection point* with all AG *disconnected*:

$$1^2 / (j0.02 + j0.08) * 100 \text{ MVA} = 1000 \text{ MVA} \quad (1)$$

2. Calculate the required fault level for the existing AG:

$$(\text{MSCR} * \text{MW rating}) = 4 * 100 \text{ MW} = 400 \text{ MVA} \quad (2)$$

3. Calculate the Available Fault Level (for [proposed AG connection](#)) = (1) subtract (2):

$$1000 \text{ MVA} - 400 \text{ MVA} = 600 \text{ MVA}$$

Now find prospective maximum ratings for the new AG:

1. Maximum rating of new AG with MSCR of 4 (AFL/MSCR) = 600/4 = 150 MW
2. Maximum rating of new AG with MSCR of 2 (AFL/MSCR) = 600/2 = 300 MW

Clearly these calculations are quite straightforward when considering AGs that share the same *connection point*.

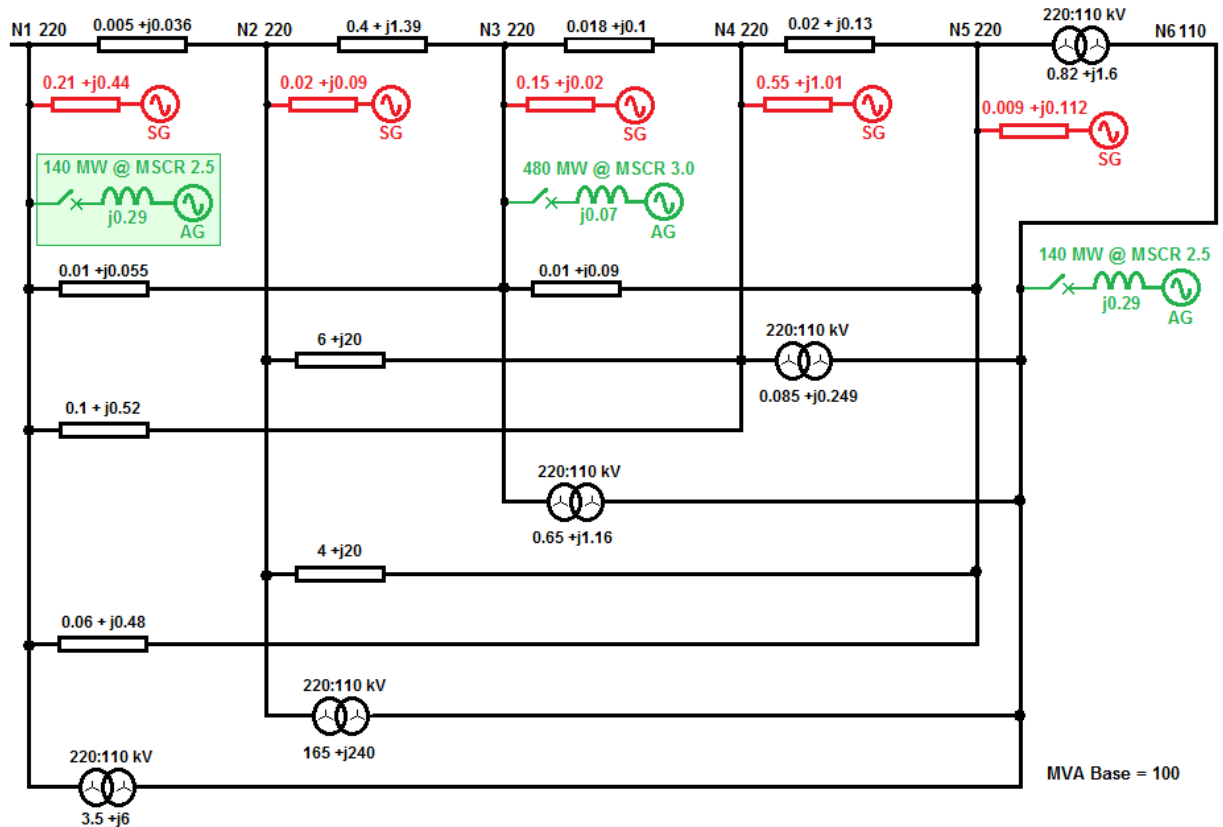
### A.2.2 Example (2) calculation of available fault level at a nearby busbar

Now consider the case shown in Figure 4 where a [new 4.6.6 Connection, comprised of](#) new AG<sub>1</sub> wishes to *connect* to a *busbar* where an existing AG is (electrically) nearby. The case is generated from a credible Tasmanian *power system* dispatch modelled in PSS/®E. For illustration purposes, the case has been reduced to a six *busbar* model, but this step is unnecessary for normal screening studies.

<sup>51</sup> This method is presented as an example. Other aggregate SCR calculation methods described in CIGRE TB 671 may be used by the NSP undertaking a Preliminary Assessment.



Figure 4 Study on impact of new AG (shaded) on Tasmanian power system

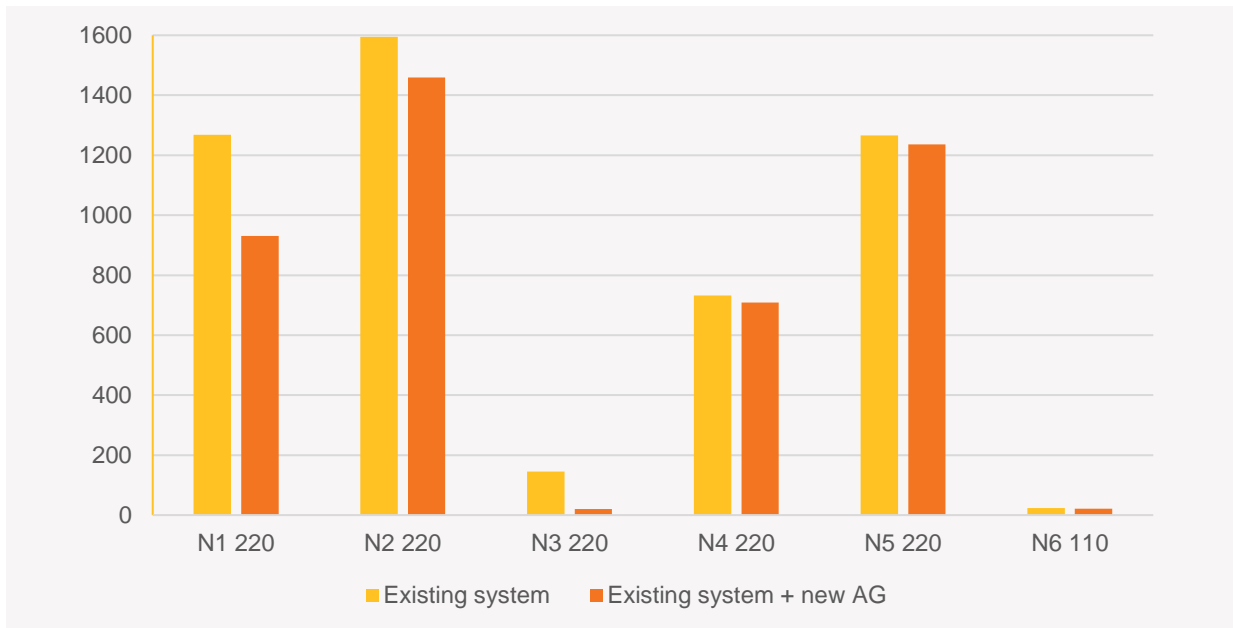


Using the same principle described in Section A.2.1, the Available Fault Level for a possible AG connection can be calculated in four steps. These calculations can be made using standard PSS/® fault level calculation tools. Note: for  $S_{SG}$  fault calculations the sub-transient impedance values ( $X_d''$ ,  $X_q''$ ) are used.

The following calculation steps are made for each busbar in the region of interest:

1. Calculate the fault level with only SG connected  $S_{SG}$  (MVA)
2. Calculate the fault level with all generation connected (but represent each AG as a Thévenin voltage source behind its Effective Impedance)  $S_{total}$  (MVA)
3. Find the difference in these two “fault levels”  $\Delta$  (MVA) =  $S_{total} - S_{SG}$
4. Find the Available Fault Level AFL (MVA) =  $S_{SG} - \Delta$

A new AG connection must not only maintain positive AFL at its local busbar but also at other (nearby) busbars that may be impacted by its connection. Refer to Figure 5, which shows that the existing AG has “consumed” most of the AFL at busbar N6 110. However, the addition of a new AG at N1 220 significantly reduces the AFL at the nearby busbar N3 220, but barely impacts the remote busbar N6 110. This is a credible Tasmanian dispatch case and indicates that any further AG penetration would trigger the requirement for detailed EMT studies.

**Figure 5 Assessment of available fault level at six Tasmanian busbar locations (new AG at N1 220)**

### A.2.3 Consideration of SVCs and STATCOMs in preliminary assessment

AG may adversely interact with those existing SVCs and STATCOMs that are nearby. Therefore, it is important to consider the impact of such SVCs and STATCOMs in the preliminary assessment. The possibility of adverse interactions with SVCs and STATCOMs can be estimated by the change in the voltage at the busbar of interest (where an AG ~~is proposed to~~ will connect) due to injection of reactive power by a SVC or STATCOM. For system normal, if the change in voltage at the busbar of interest is more than 3%<sup>52</sup>, or as otherwise agreed by relevant NSP, due to the SVC/STATCOM, a full impact assessment should be carried out to study the possible interactions of AG with SVC/STATCOM.

As an example, if rating of the STATCOM connected in the area is  $\pm 100$  MVar and change in the voltage ( $\Delta V$ ) at the bus of interest due to this 100 MVar injection by STATCOM is  $>3\%$ , or as otherwise agreed by relevant NSP, detailed EMT studies should be carried out to analyse the possible interactions between AG and SVC/STATCOM.

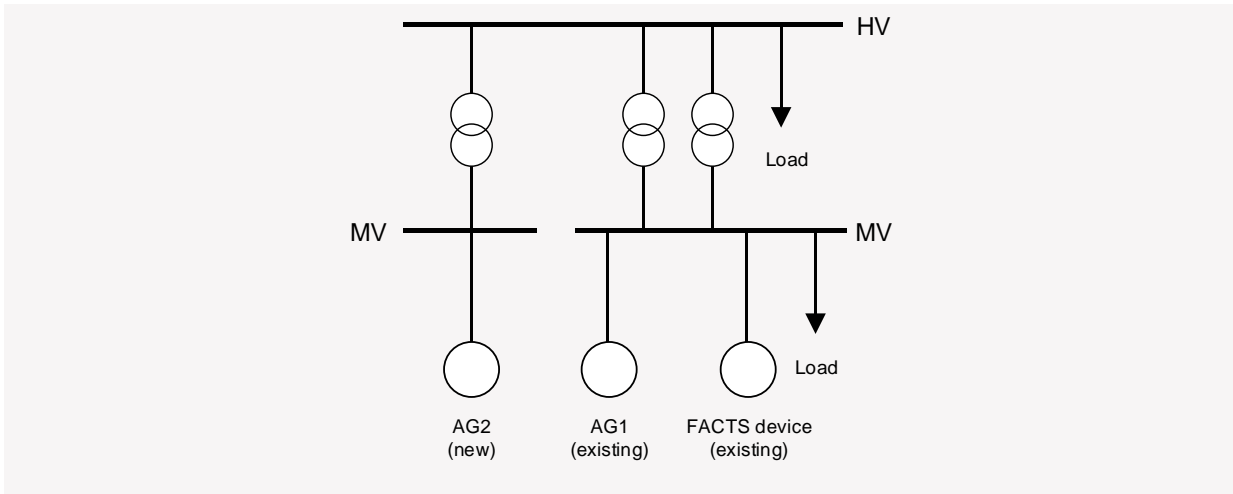
## A.3 Full stability impact assessment

### A.3.1 Example 1

This section presents a case study based on a practical scenario of integrating *asynchronous generation* into a low system strength *network*. Figure 6 shows a schematic diagram of the substation under consideration. The substation is located remotely from the *transmission network* and connected to the *transmission network* via only a single long *transmission line*. Therefore, the substation is inherently characterised by a very low fault level and high X/R ratio. Further to the existing *asynchronous generation* at the substation itself, there is a FACTS device in operation within the substation.

<sup>52</sup> TR IEC 61000.3.7:2012 10.3 "Table 6 - Indicative planning levels for rapid voltage changes

**Figure 6 Single line diagram of substation under study**



**Preliminary Assessment**

The substation already has one *asynchronous generating system (AG1) connected* and a [4.6.6 Connection, comprised of](#) new proposed *asynchronous generating system (AG2) is planned for connection*. Table 4 shows three phase short circuit capacity and X/R ratio at the HV bus of the substation, and SCR pre- and post-connection of the new AG2.

**Table 4 SCR values with and without a proposed connection**

Network configuration	SCC HV bus (MVA) <sup>A</sup>	X/R ratio	SCR <sup>B</sup> (Pre-connection of AG2)	SCR <sup>C</sup> (Post-connection of AG2)
System normal	340	6	6.5	1.4

A. With AG Plant 1 and 2 disconnected.  
 B. SCR measured at HV bus.  $SCR = (SCC / \text{Total substation generation})$  at HV bus.  
 C. SCR measured at HV bus.  $SCR = (SCC / \text{Total substation generation})$  at HV bus.

The equipment supplier of the existing AG1 specifies a SCR of 3 at the *generating unit* terminals to guarantee satisfactory operation of its controls. The equipment supplier of the new AG2 has specified a SCR of 1.2 at the HV *connection point* as the limiting value for satisfactory operation of the *generating units*.

Outcomes of the Preliminary Assessment highlight that the *connection* of the new AG2 results in a situation where AG1 would not be able to operate satisfactorily because of reduced SCR.

To better understand performance of each AG in isolation and concurrently, the following sets of studies were carried out using SMIB representation:

- Only AG1 operating at maximum active power (Pmax).
- Only AG2 operating at maximum active power (Pmax).
- AG1 and AG2 operating at maximum active power (Pmax).

The ability of substation *plant* to operate satisfactorily is monitored in response to varying system strength, with no disturbance applied. Table 5 summaries the outcomes of the study.

**Table 5 Summary of results**

AG1 status	AG 2 status	SCC at HV bus (MVA)	X/R ratio	SCR at HV bus	Outcome
Pmax	Out of service	300	6	6	Stable
Pmax	Out of service	200	6	4	Unstable – Repetitive FRT trigger
Out of service	Pmax	400	6	2	Stable
Out of service	Pmax	300	6	1.5	Stable
Out of service	Pmax	200	6	1	Unstable
Pmax	Pmax	750	6	3	Stable
Pmax	Pmax	500	6	2	Stable
Pmax	Pmax	340 <sup>53</sup>	6	1.4	Unstable - Repetitive FRT trigger (AG2)

The following summarises the outcomes of the Preliminary Assessment:

- Studies confirm the equipment capability specified by the equipment supplier of AG2, which exhibits satisfactory performance for SCR of >1.5, and failed under SCR of 1.
- AG1 requires a system strength equivalent to an SCR > 4 for its satisfactory performance.
- Noting that the present SCC at the HV bus of the substation is 340 MVA, the results indicate possible system strength related issues will arise with the *connection* of AG2 at the proposed maximum capacity.

### Full Assessment

As part of this assessment, stability of this sub-*network* was assessed pre- and post-*connection* of AG2 using detailed EMT-type models of AG1, AG2, FACTS device, and nearby *network*.

Figure 7 to Figure 9 show the performance of the sub-*network* before *connection* of AG2, when operating under system normal *network* configuration, with no disturbance. It is apparent that the dynamic performance of this sub-*network* is satisfactory. This also supports the finding of Preliminary Assessment.

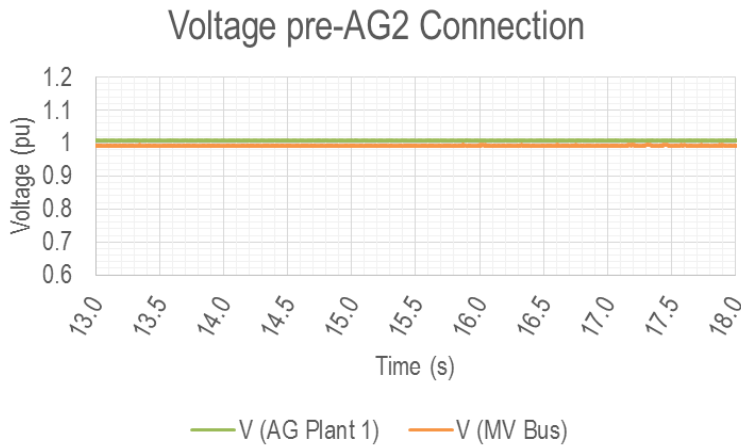
Figure 10 to Figure 12 show the performance of the sub-*network* after the *connection* of AG2, when operating under system normal *network* configuration, with no disturbance. The substation response post-*connection* with the proposed maximum capacity results in stability issues (repetitive entry / exit into / from FRT controls by the existing AG1), as expected from the findings of Preliminary Assessment. It is evident from the responses that the *plant* within this sub-*network* interact with each other resulting growing oscillations in *voltage* and eventually triggers AG1 FRT operation. As AG1 comes out of the FRT controls, the interaction resumes and causes FRT operation leading into a repeated FRT for AG1.

### Summary

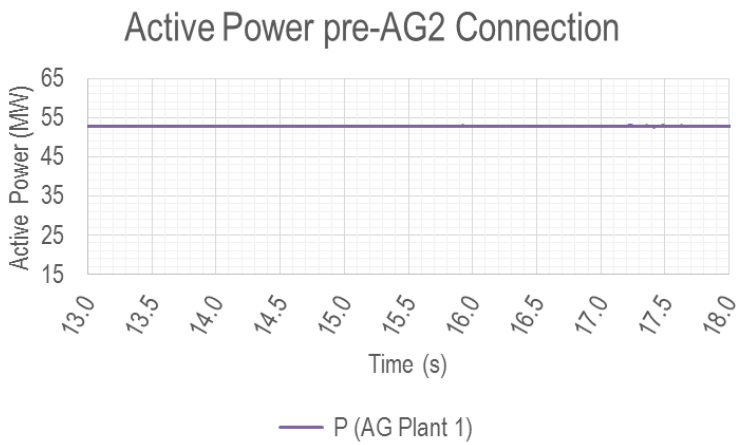
*Connection* of an AG to a sub-*network* with existing AG connected and characterised by low system strength is studied. Because of reduced SCR, the study confirms that *connection* of new AG results in unstable operation of existing AG even without any disturbance applied under system normal configuration. The study concludes that *connection* of new AG *plant* is not possible without any Mitigation Measures.

<sup>53</sup> Existing SCC at the HV bus of the substation under system normal network configuration.

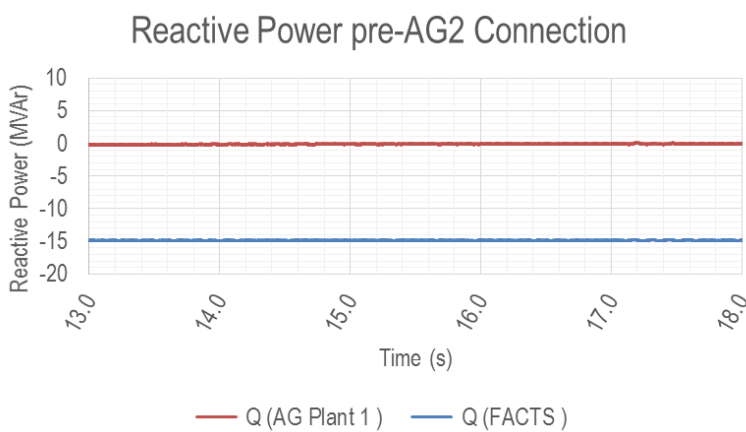
**Figure 7 Dynamic behaviour of sub network pre-AG2 connection**



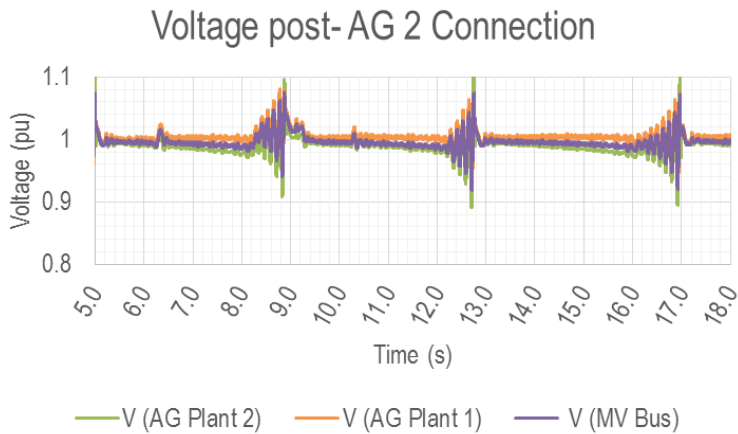
**Figure 8 Dynamic behaviour of sub network pre-AG2 connection**



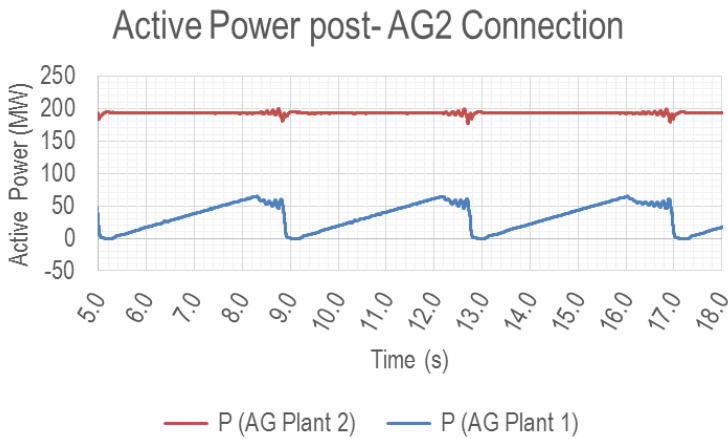
**Figure 9 Dynamic behaviour of sub network pre-AG2 connection**



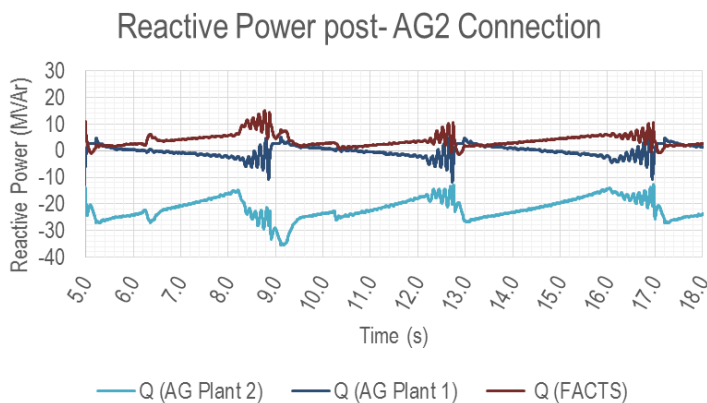
**Figure 10 Dynamic behaviour of sub network post-AG2 connection**



**Figure 11 Dynamic behaviour of sub network post-AG2 connection**



**Figure 12 Dynamic behaviour of sub network post-AG2 connection**



### A.3.2 Example 2

Unlike Example 1, which discusses steady state instability due to the *adverse system strength impact* of two *asynchronous generating systems*, Example 2 presents a practical example whereby an *adverse system strength impact* manifests itself into an inability to ride through faults. Detailed vendor-specific EMT-type models of both solar farms are used.



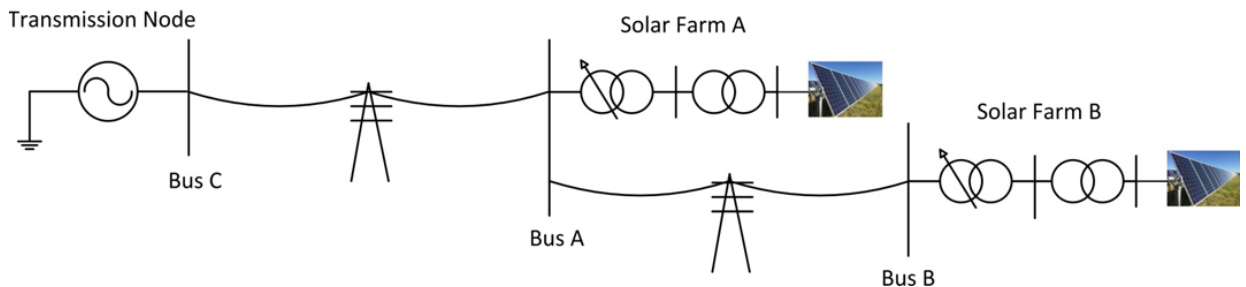
A simplified representation of the AC *network* used for this study is shown in Figure 13. In this *network* the *connection point* for Solar Farms A and B is Bus A and Bus B, respectively. Table 6 shows the capacity of solar farms and fault levels at various nodes of the *network*.

This *network* is used to analyse the performance of solar farms *connecting* to a low system strength *network*. Acceptable performance is assessed in terms of the ability of *plant* to successfully ride through faults and recover to a new steady state operating condition. For the purpose of analysing performance of this *network* four different scenarios are considered. They are:

- Only Solar Farm A connected
- Only Solar Farm B connected
- Both Solar Farm A and B connected
- Both Solar Farm A and B connected, with a synchronous condenser connected to Solar Farm B.

For each scenario a temporary two-phase-to-ground fault was applied for 430 ms at Bus A. The simulation results and associated observations are outlined below.

**Figure 13 Network under study**



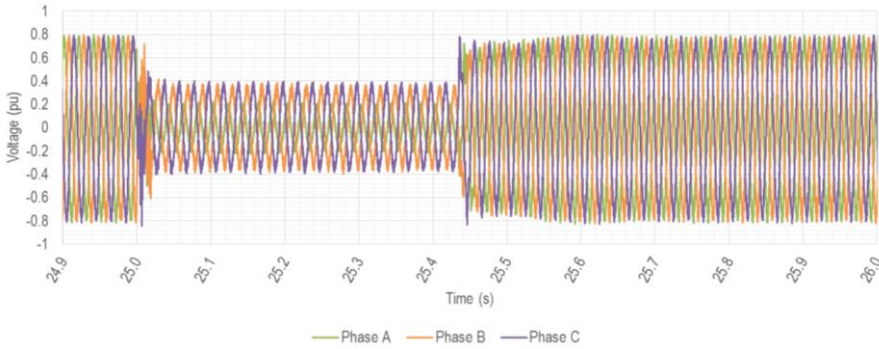
**Table 6 System data used for the study**

Parameter	Value
Rated voltage – Bus A, Bus B and Bus C	132 kV
Solar Plant A capacity	45 MW, 55 MVA
Solar Plant B capacity	45 MW, 55 MVA
Fault levels	
Solar Plant A POC – Bus A	117 MVA
Solar Plant B POC – Bus B	102 MVA
Transmission node – Bus C	1,200 MVA

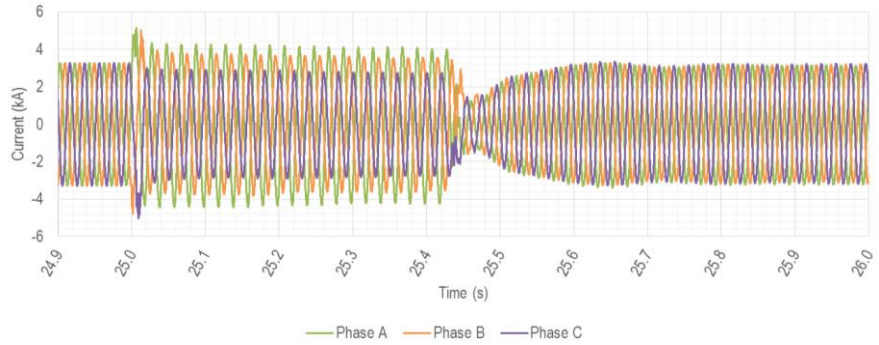
### Only Solar Farm A connected

The purpose of this scenario is to test the performance of Solar Farm A in isolation. Figure 14 to Figure 17 show the performance of Solar Farm A in the absence of Solar Farm B. These figures indicate that Solar Farm A can successfully ride through the disturbance and achieve a new steady state operating point.

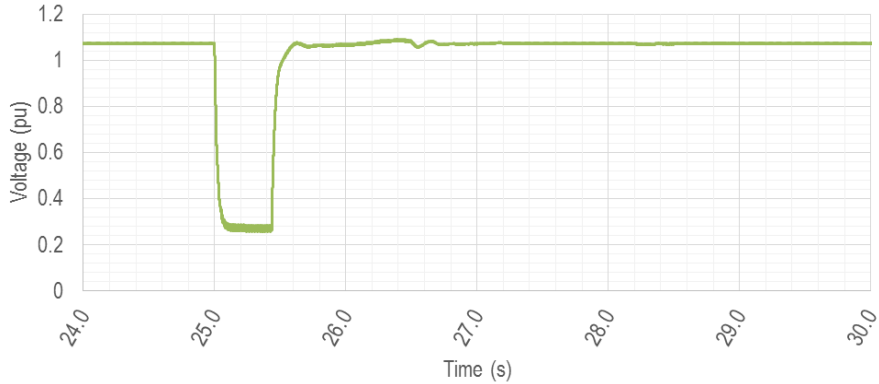
**Figure 14 Solar Farm A inverter terminal voltage**



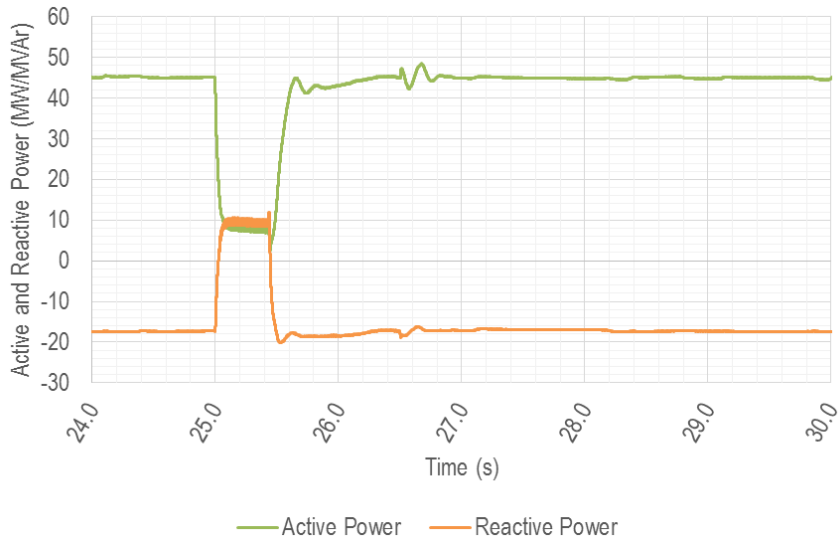
**Figure 15 Solar Farm A inverter terminal output current**



**Figure 16 Solar Farm A POC voltage**



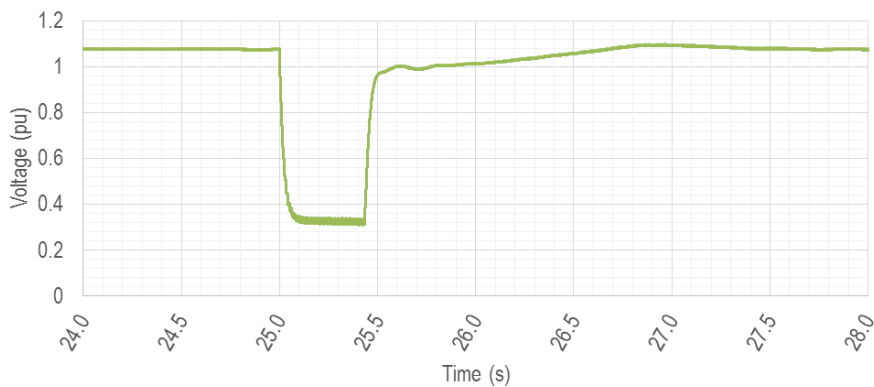
**Figure 17 Solar Farm A POC active and reactive power**



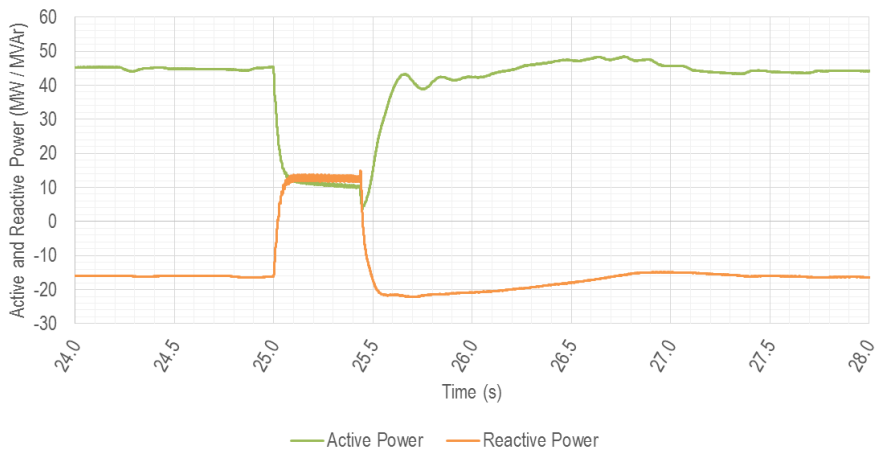
**Only Solar Farm B connected**

The purpose of this scenario is to test performance of Solar Farm B in isolation. Figure 18 and Figure 19 show the performance of Solar Farm B in the absence of Solar Farm A. These figures show that Solar Farm B can successfully ride through the disturbance.

**Figure 18 Solar Farm B POC voltage**



**Figure 19 Solar Farm B POC active and reactive power**

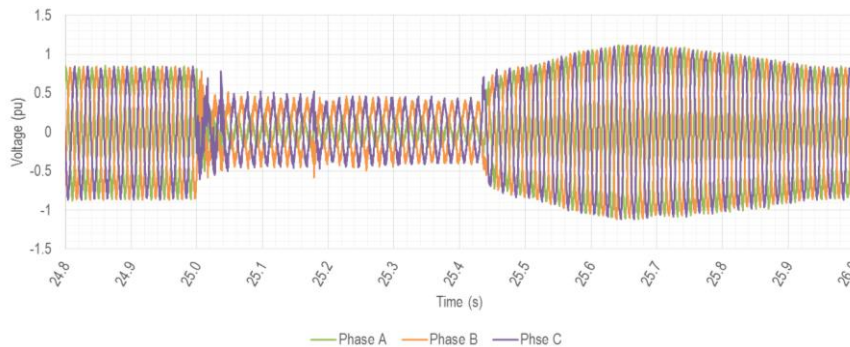


**Both Solar Farm A and B connected**

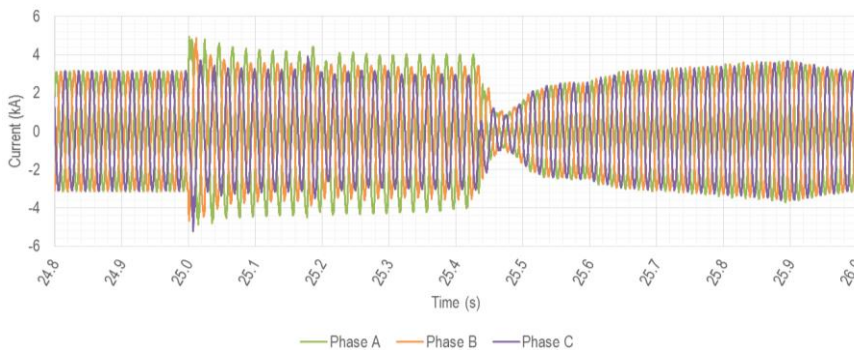
The purpose of this study is to test the performance of Solar Farm A and B when both Solar Farms A and B are *connected* to the *network*.

Figure 20 to Figure 23 show the performance of Solar Farm A. The results show an unsuccessful fault recovery response for Solar Farm A that fails to reach a new steady state condition after the fault was cleared. In this case, the values of SCR at Bus A and Bus B, when measured in absence of Solar Farm B and A respectively, is not different, however, the aggregate SCR of the combined system (including both Solar Farm A and B) has reduced. Solar Farm A is not therefore able to ride through the same fault when Solar Farm B is operational. This shows a degradation in the performance of solar farms when *connected* in electrical proximity of each other.

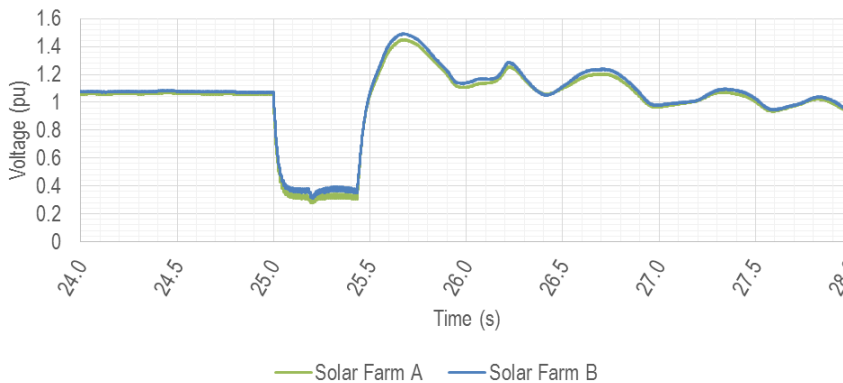
**Figure 20 Solar Farm A inverter terminal voltage**



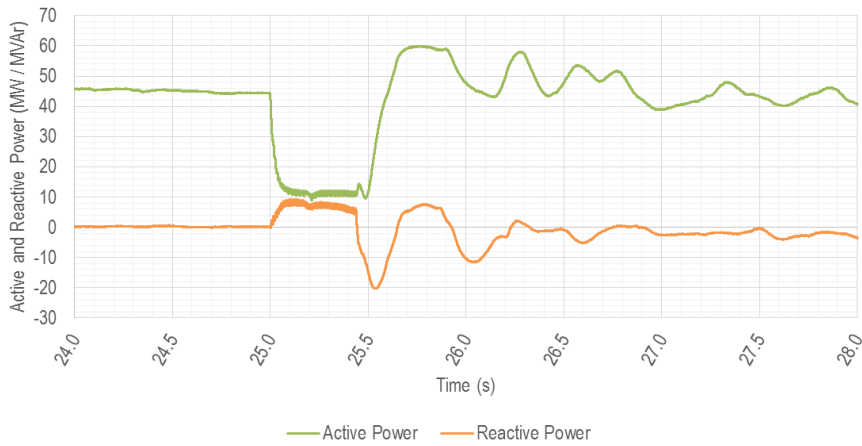
**Figure 21 Solar Farm A inverter terminal output current**



**Figure 22 Solar Farm A and B POC voltage**



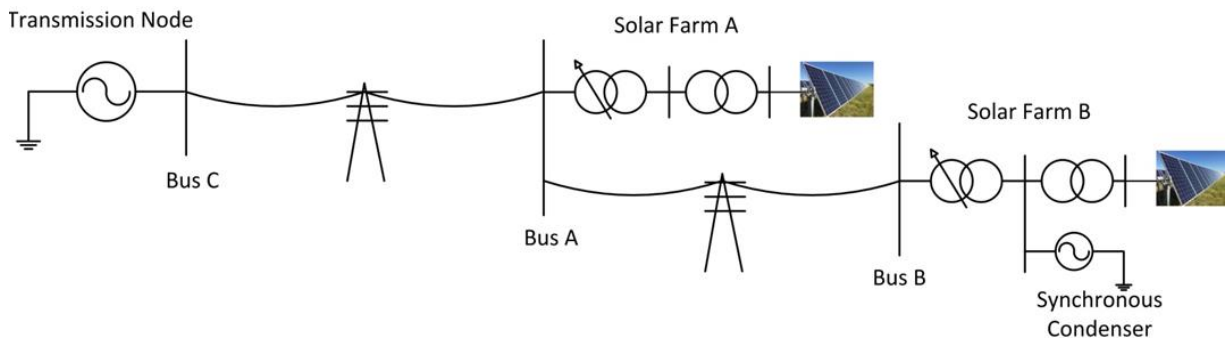
**Figure 23 Solar Farm A POC active and reactive power**



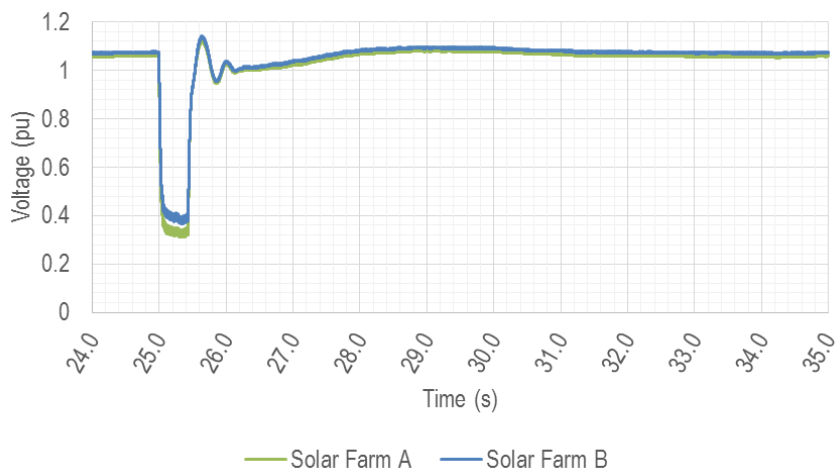
**Both Solar Farm A and B connected – with synchronous condenser at Solar Farm B**

For this scenario a 15 MVar *synchronous condenser*, as shown in Figure 24, was *connected* to the MV bus of Solar Farm B to increase the system fault level. Figure 25 and Figure 26 show the performance of Solar Farm A and B when subjected to the same disturbance. Detailed EMT-type simulation studies indicate that none of the two Solar Farms can ride through the disturbance and achieve a new steady state operating condition.

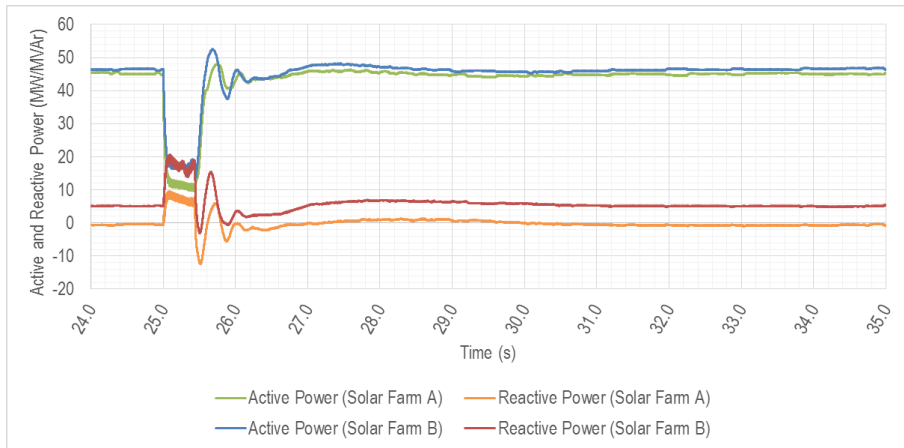
**Figure 24 System under study**



**Figure 25 Solar Farm A and B POC voltage**



**Figure 26 Solar Farm A and B POC active and reactive power**



**Summary**

*Connection* of two solar farms under low system strength conditions is studied. Results obtained from EMT-type simulation studies demonstrate that with both solar farms are *connected* to the *network*, neither can ride through the same credible fault that was able to ride through when operated in isolation. A *synchronous condenser* was used as a Mitigation Measure and demonstrated to be effective.



## APPENDIX B. CHOICE OF SCR AS THRESHOLD FOR PRELIMINARY ASSESSMENT

To determine the impact of variations of SCR and X/R ratio on stability of *asynchronous generating systems* during fault conditions, *power system* simulation studies are conducted with detailed EMT-type simulation models of four large-scale *transmission connected* wind farms and one large-scale *transmission connected* solar farm.

### B.1 Methodology

The following outlines the methodology that was used to identify appropriate value of SCR that could be used as a trigger for Full Assessment.

- Detailed site-specific vendor-specific, EMT-type simulation models were used.
- A voltage disturbance resulting in a residual voltage of 0.7 pu for 2 s was applied at the connection point. A shallower longer duration disturbance was demonstrated to have a more destabilising impact on performance of the wind farms and solar farm.
- Each of the SCR and X/R ratio were varied in isolation to determine its impact on the wind/solar farm stability when subjected to the above disturbance.
- Where the model was unable to initialise under low SCR or high X/R ratio conditions, the model was re-initialised with higher than intended SCR or lower X/R ratio. The SCR or X/R ratio was then changed to the intended value upon achieving the steady state conditions.
- No attempts were made to tune the control system parameters to make the generating units suitable for low system strength conditions.

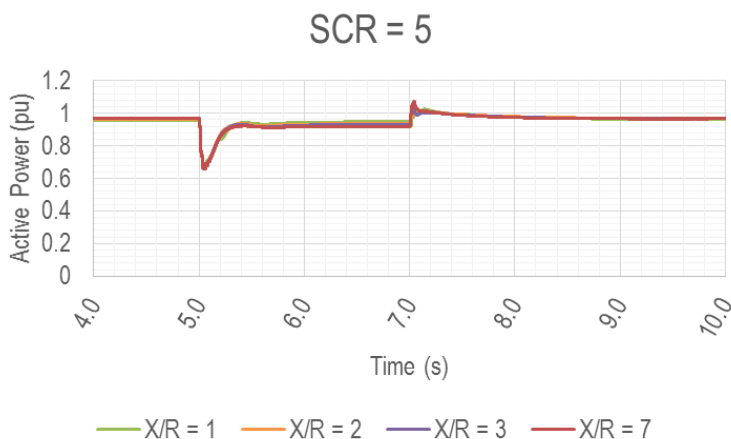
### B.2 Simulation results

Each model was tested under various SCR threshold and X/R ratio conditions. This section presents an example result.

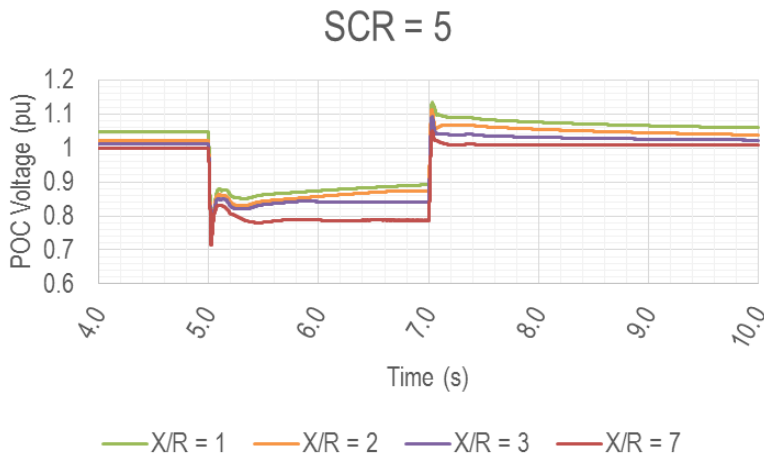
#### B.2.1 $SCR \geq 3$

Figure 27 to Figure 30 show the response under different X/R ratios when the SCR at the point of connection is  $\geq 3$ . These results highlight that the performance is not materially affected by changes in the X/R ratio when the SCR at the point of connection is  $\geq 3$ .

Figure 27 Active power



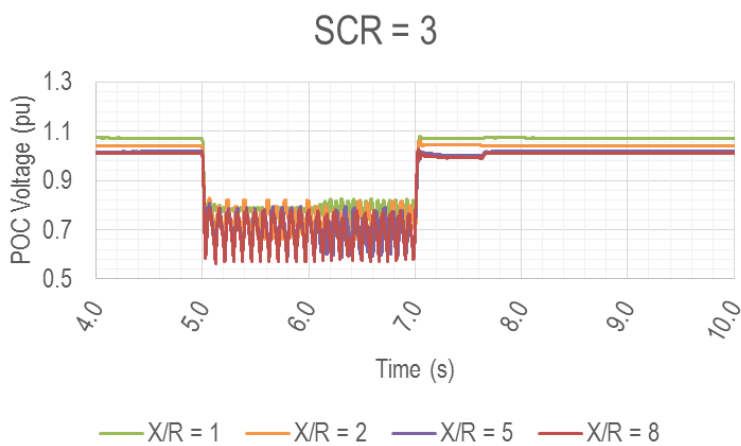
**Figure 28 Voltage at point of connection**



**Figure 29 Active power**

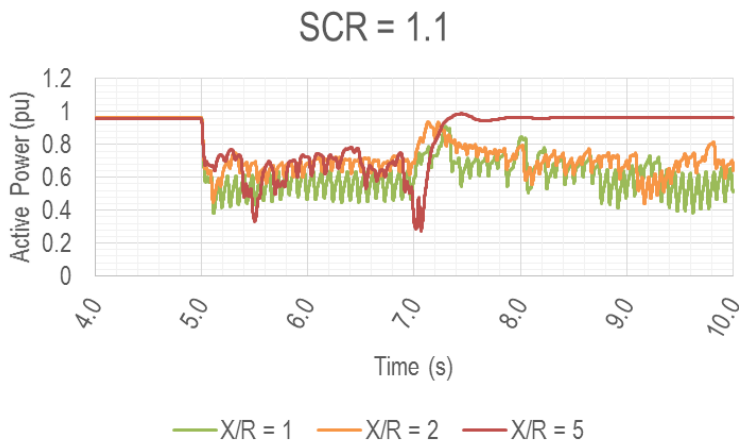


**Figure 30 Voltage at point of connection**



**B.2.2 SCR < 3**

Figure 31 and Figure 32 show the response under different X/R ratios when the SCR at the *connection point* is < 3. These results highlight linkage between the SCR and X/R ratio becomes more pronounced when the SCR is < 3.

**Figure 31 Active power****Figure 32 Voltage at point of connection**

### B.3 Summary and conclusions

The key outcomes of this analysis are as follows:

- All EMT models exhibit stable performance where the SCR is  $>3$  at the connection point. It is noted that the SCR at a generating unit's terminals will be lower than that of the connection point.
- Reducing the SCR below 2 will increase the likelihood of power system instability.
- A general trend is that when the SCR is above a certain threshold, the model is not sensitive to the X/R ratio.
- The linkage between the SCR and X/R ratio becomes more pronounced as the SCR ratio declines.
- With SCR of  $>3$ , X/R ratio has a negligible impact.
- In some cases, higher X/R ratios have a destabilising impact as opposed to lower X/R ratios. It has been observed that some models exhibit stable response only for X/R ratios  $>2$ , when operated under very low SCR conditions.
- The SCR threshold during Preliminary Assessment can be set at 3 based on performance observed by EMT simulation studies of four large-scale *transmission connected* wind farms and one large-scale *transmission connected* solar farm.

## APPENDIX C. CONSIDERATION OF FACTS DEVICES DURING PRELIMINARY ASSESSMENT

To determine whether FACTS devices should be included for the purposes of a Preliminary Assessment, time-domain EMT-type simulation studies were carried out with and without FACTS devices under low system strength conditions to determine the extent to which these devices can impact system stability. A large-scale *transmission connected* wind farm was chosen as an example and the following combinations were studied:

- Wind farm with no FACTS devices within the generating system or in the wider transmission network;
- Wind farm with STATCOMs within the wind farm reticulation system but no FACTS devices within the wider network; and
- Wind farm with no FACTS devices with the reticulation system but with SVCs connected to transmission network outside the *generating system*.

### C.1 Methodology

The following methodology was used to identify the appropriate value of SCR that could be used as a trigger for a Full Assessment:

- Three large-scale transmission connected wind farms in the NEM were chosen.
- The stability of each model was tested for different system strength conditions ranging from an SCR<sup>54</sup> of just above 1 (very weak) to above 3 (reasonably strong).
- Detailed site-specific, vendor-specific, EMT-type simulation models were used.
- A voltage disturbance resulting in a residual voltage of 0.7p.u.<sup>55</sup> for 2 seconds was applied at the connection point. A shallower longer duration disturbance was demonstrated to have a more destabilising impact on performance of wind farms.
- Each wind farm was studied with and without both a locally connected STATCOM, operating in power factor (PF) mode, and a transmission network connected SVC.
- Each of the SCR and X/R ratios were varied in isolation to determine their impact on the wind farm stability when subjected to the above disturbance.
- Where the model was unable to initialise under low SCR or high X/R ratio conditions, the model was re-initialised with higher than intended SCR or lower X/R ratio. The SCR or X/R ratio was then changed to the intended value upon achieving initial steady state conditions.

### C.2 Simulation results

Each model was tested with and without locally *connected* STATCOM and *transmission connected* SVC under different SCR and X/R ratios. This Section C2 presents example results.

#### C.2.1 SCR $\geq 3$

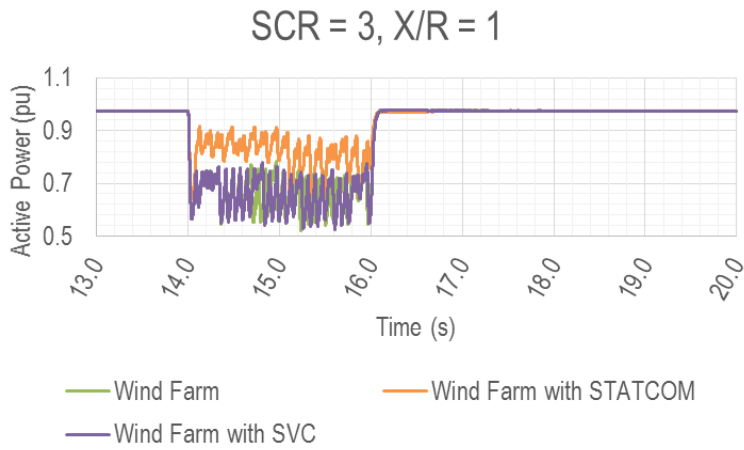
Figure 33 to Figure 38 show the impact of STATCOM and SVC on the model performance with an SCR<sup>56</sup>  $\geq 3$  with different X/R ratios.

<sup>54</sup> SCR calculated at the *connection point*.

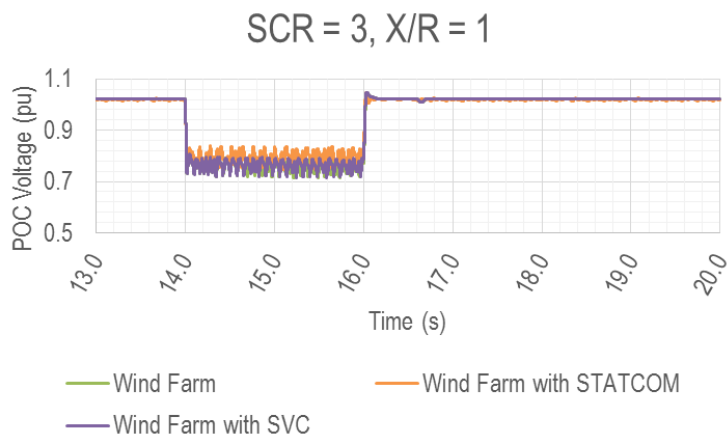
<sup>55</sup> Residual *voltage* of 0.7p.u. is determined for a wind farm without a FACTS device. With the inclusion of a FACTS device, residual *voltage* may not achieve this value.

<sup>56</sup> SCR calculated at the *connection point*.

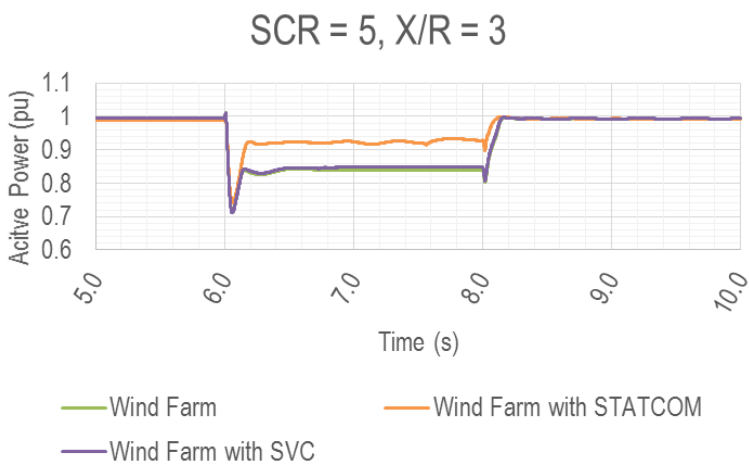
**Figure 33 Active power**



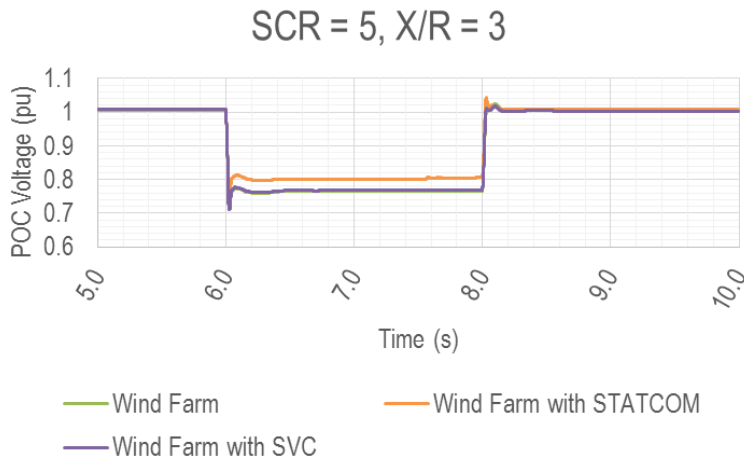
**Figure 34 Voltage at point of connection**



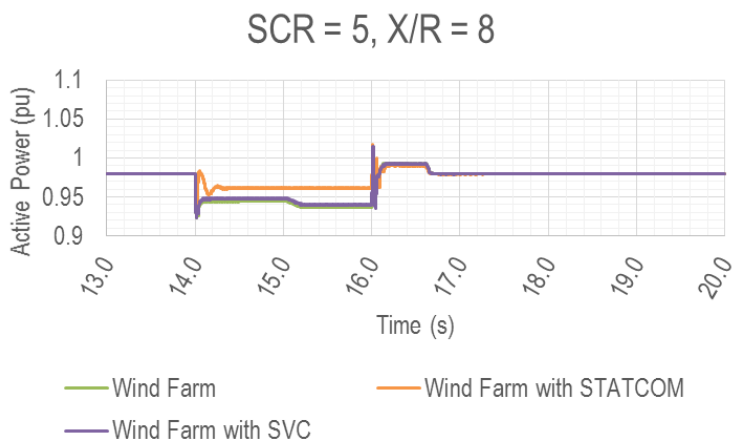
**Figure 35 Active power**



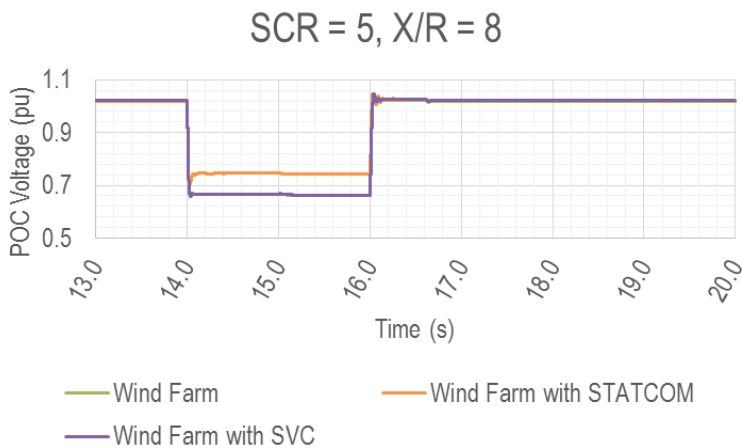
**Figure 36 Voltage at point of connection**



**Figure 37 Active power**



**Figure 38 Voltage at point of connection**



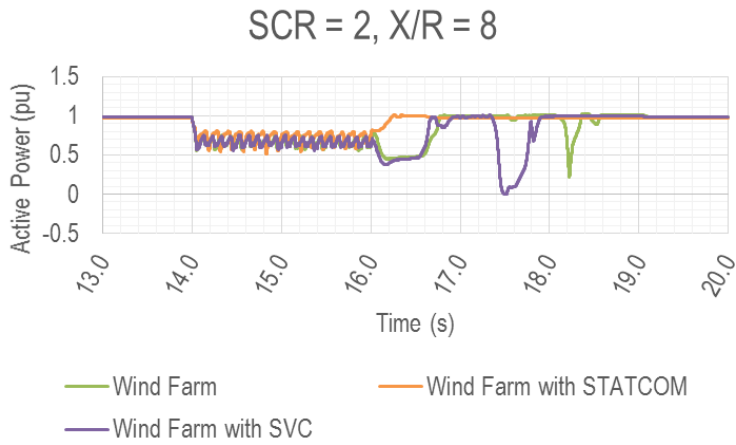
**C.2.2 SCR < 3**

Figure 39 to Figure 42 shows the impact of STATCOM and SVC on the model performance when  $SCR^{57} < 3$  with different X/R ratios.

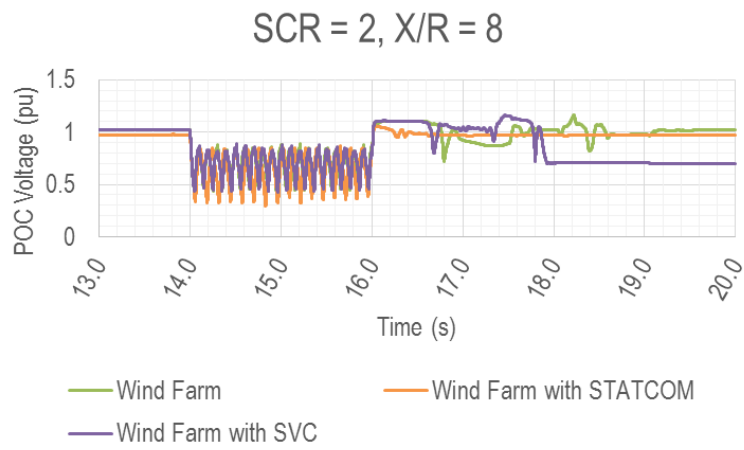
<sup>57</sup> SCR calculated at point of connection



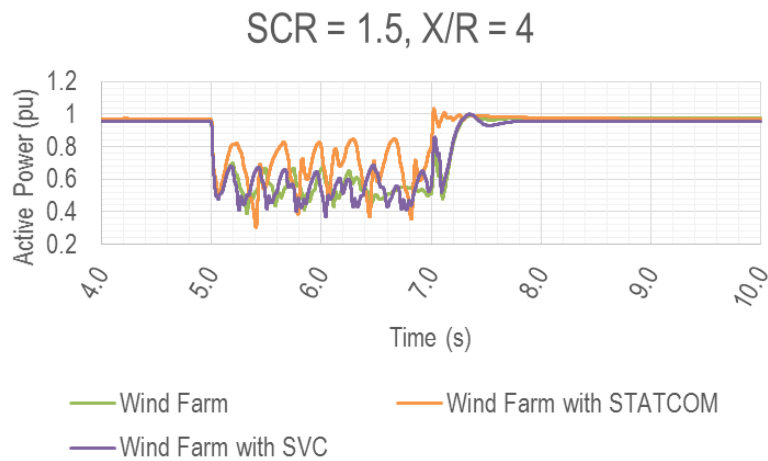
**Figure 39 Active power**

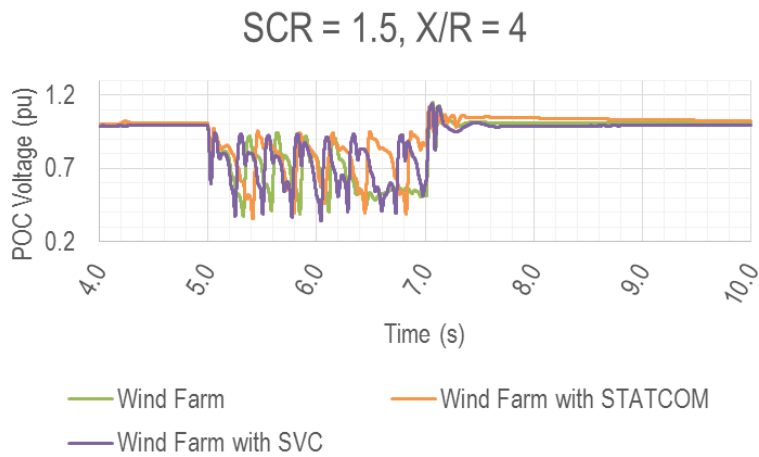


**Figure 40 Voltage at point of connection**



**Figure 41 Active power**



**Figure 42 Voltage at point of connection**

### C.3 Summary and conclusions

The key outcomes of this analysis are as follows:

- For  $SCR \geq 3$ , neither STACOM nor SVCs have a material impact on system stability. The impact does not change for low or high X/R ratios.
- System strength impact of STACOMs connected within the asynchronous generating system and transmission connected SVCs on *asynchronous generating systems* can be ignored during Preliminary Assessment.